

FMZ 5000 Fire Detection Systems & Suppression Control

Product catalogue | EMEA





Version 2023-01

Product Catalog

Fire Detection Systems and Suppression Control Panels

This product catalog is intended for sales purposes only.
For planning, installation, commissioning and operation,
please refer to the respective valid technical documentation.



Content

Fire detection and suppression control panels	Chapter 1
Small control panels	
FMZ 5000 base unit, FMZ 5000 mod S	
FMZ 5000 FMZ 5000 mod S SUZ	
FMZ 5000 FMZ 5000 mod S CA VK	
FMZ 5000 FMZ 5000 mod S VK	
FMZ 5000 modules/cards, FMZ 5000 mod S	
FMZ 5000 complete OU	
FMZ 5000 base unit	
FMZ 5000 modules/cards	
FMZ 5000 enclosure/front plates	
FMZ 5000 printer	
FMZ 5000 power supply units	
FMZ 5000 batteries	
FMZ 5000 fire alarm panel accessories	
FMZ 4100 cards	
Inveron Hazard Management System	
Monitoring and release devices	Chapter 2
Water-based suppression systems	
Gas-based suppression systems	
Fire brigade accessories	Chapter 3
FMZ 5000 mod S	
Fire brigade control panel	
Fire brigade display panel	
FMZ 5000	
Fire brigade control panel	
Fire brigade display panel	
Fire brigade information and operating system	
Accessories	
Frames	
Graphic panel	
System accessories	Chapter 4
Overvoltage protection.	
Overvoltage protection, Information technology	
Overvoltage protection, test equipment	
Overvoltage protection, Information technology, Ex	
Overvoltage protection, Energy technology	
Overvoltage protection, accessories	
Manual call points	Chapter 5
DMX indoor application, addressable	
DMX indoor application, conventional	
DMX indoor application, Ex	
DMX indoor application, accessories	
DMX outdoor application, addressable	
DMX outdoor application, conventional	
DMX outdoor application, addressable, Ex	
DMX outdoor application, conventional, Ex	
DMX outdoor application, accessories	
DMX accessories, general	



Contents

Standard detectors

Chapter 6

- Optical smoke detectors, addressable
- Ionization smoke detectors, addressable
- Multisensor detectors, addressable
- Heat detectors, addressable
- Detector accessories, addressable
- Optical smoke detectors, addressable, Ex
- Ionization smoke detectors, addressable, Ex
- Heat detectors, addressable, Ex
- Detector accessories, addressable, Ex
- Optical smoke detector, conventional
- Ionization smoke detectors, conventional
- Heat detectors, conventional
- Detector accessories, conventional
- Optical smoke detector, conventional
- Multisensor detectors, conventional
- Heat detector, conventional
- Detector accessories, conventional
- Optical smoke detectors, conventional, Ex
- Ionization smoke detectors, conventional, Ex
- Heat detectors, conventional, Ex
- Detector accessories, conventional, Ex
- Detector accessories
- Modules, addressable, DIN rail mounting
- Modules, addressable, wall mounting
- Modules, addressable
- Modules, conventional
- Test equipment
- Test equipment, accessories

Industrial detectors

Chapter 7

Optical detection

- UniVario IR flame detector
- UniVario IR flame detector, Ex
- UniVario UV flame detector
- UniVario UV flame detector, Ex
- UniVario YMX
- UniVario YMX, accessories

Thermal detection

- UniVario Heat detector, standard
- UniVario Heat detector, Ex standard
- UniVario High temperature heat detector FS
- UniVario High temperature heat detector FS, Ex
- UniVario High temperature heat detector FS Flex
- UniVario High temperature heat detector FS Flex, Ex
- UniVario Detector accessories
- UniVario Test equipment
- IR flame detector
- IR flame detector, Ex
- UV flame detector, Ex
- Detector accessories
- Flame detector accessories



Contents

Aspirating smoke detectors AMX 4004, basic devices AMX4004, detector heads HELIOS AMX5000, basic devices HELIOS AMX5000, detector heads HELIOS AMX5004 C HELIOS AMX5000, accessories Vesda Laser, basic devices Sampling pipes Aspirating pipes - connections/accessories Aspirating tube system, mounting accessories Fittings OneU®	Chapter 8
Special detectors Linear heat detectors Linear smoke detectors Linear smoke detectors, accessories Cyclone monitoring Cyclone monitoring, Ex	Chapter 9
Notification devices Audible Audible, addressable Audible, Ex Visual Visual, addressable Visual, Ex Audible/visual Audible/visual, addressable Audible/visual, lighted warning display Audible/visual, Ex	Chapter 10
Gas detection Carbon dioxide warning device CO ₂ Gas emission detector Gas emission detector, Ex5	Chapter 11
Door hold-open technology Holding solenoid Anchor plate Push button	Chapter 12
Cable / installation material Cables Cable glands Cold shrink tube Adapters Resistors	Chapter 13



Fire detection and suppression control panels

Chapter 01



Fire detection and suppression control panels

FMZ 5000 base unit



FMZ 5000 – A control panel range for all safety concepts

Each FMZ 5000 model is a highly modern unit combining fire detection and suppression control in a fully modular design with freely programmable controls to suit virtually any project requirement.

Planning, operation and service made easy

The same hardware modules are used for both fire detection systems and suppression systems, in three different base unit layouts for wall-mounted installation or in 19" free-standing cabinets. The MxSysCon configuration program with full graphical user interface is used to adapt those hardware modules to the specific project, in the office or on site any time right up to the moment of startup.

Optimal value for money – you only buy what you currently need

Changes in building use, in fire alarm controls or to your fire protection system can be implemented easily in the FMZ 5000 by replacing / adding / removing plug-in modules and adapting the configuration. Rewiring within the fire detection panel is not required.

State of the art technology

All modern functions of today's fire detection and suppression control panels are combined in a single device:

- Clear display of alarms and other signals and easy operation in every situation with the large graphical display screen and user menu interface.
- Loop technology for detection / control / monitoring with all modern features and any number of branches - including explosion hazard areas.
- Operation of detectors for rough industrial environments in a wide range of operating voltages for all fire characteristics (such as heat - smoke - flame - CO fire gas etc.), also directly connected without couplers on the Loop.
- Up to 32 fire alarm and display / operating panels can be redundantly loop networked.
- Communication with building management systems or other control stations via open interfaces or field bus protocols.
- The freely programmable user interface meets all requirements for the display of messages and the controls to be executed in any logical and time combination.
- Redundant layout for fire detection and control of multi-zone extinguishing systems of any type.
- Easy adaptation to changing conditions of use and tasks through plug-in modules and graphical configuration.

A fire detection panel system for universal application, with two VdS device approvals:

- G204124** Fire detection panel in accordance with EN54-2 A1 : 2006, EN54-4 A2 : 2006; 0786-CPD-20843
- G205019** Electrical control device for multi-zone gas extinguishing systems in accordance with EN 12094-1 :2003; 0786 - CPD - 20222 as well as activation and control of water suppression systems

- International approvals like FM, CCC, RU for all main markets.



Fire detection and suppression control panels

Small control panels

Fire alarm panel SOLID CPS Cabinet Protection System Configuration 2



Application

Use as fire detection and suppression control panel in single-zone special extinguishing system

Technical specifications

Mains voltage	115 V / 230 V AC -10% +15%
Mains frequency	50 Hz - 60 Hz
Operating voltage	19.6 V - 28.7 V DC
Power supply unit	19.6 V - 28.7 V DC / 3 A
Quiescent current	80 mA
Battery capacity	2 x 12 V / 2.2 Ah internal
Nom. output voltage	24 V DC
Output current max.	2.4 A
External control voltage	19.6 V - 28.7 V DC
Collective relays	1 pre-alarm, 1 fire, 1 operation in each case
Contact load	1 x 1 A / 30 V DC and 3 x 2 A / 230 V AC
Max switching capacity	1 x 30 VA / 3 x 460 VA
Ambient temperature	-5 °C to +50 °C (+23 °F to +122 °F)
Storage temperature	-20 °C to +65 °C (-4 °F to +149 °F)
Relative humidity	max. 90 % no condensation
Dimensions	340 x 300 x 140 mm (WxHxD) 13.4 x 11.8 x 5.5 inch (WxHxD)
Enclosure	Polycarbonate
IP rating (EN 60529)	IP 66
Color	RAL 7035
Weight	approx. 4.2 kg (without batteries)
Mounting	Wall-mounted installation

Part no.: 929020

Small control panel of the SOLID control panel family in a wall housing. For operation of heat detectors, smoke detectors and multisensor detectors in standard design by different manufacturers (Apollo, System Sensor) and for monitored triggering of alarm devices, solenoid valves and release devices. Explicit LED notification and group specific control units allow a quick and intuitive control of the panel.

Product features

- Two detector groups for fire detection through dual group dependency
- One detector group for fire detection
- One detector group for triggering the extinguishing system manually
- One control input for electrical blocking of the extinguishing system
- One control unit monitoring extinguishing agents
- One control unit for audible notification devices
- One control unit for optical notification devices
- One control unit for valve control
- One relay 24 V DC for signal transmission (pre-alarm)
- Three relays 230 V DC for signal transmission (pre-alarm, fire, operating state)
- One internal contact group for actuation of an input module IUX 760 M-I for condition transmission (fire, fault) via Loop AP XP to a superordinated control panel
- Collective and individual LEDs, partly red/yellow

Included in delivery

Control panel with display and operating front panel, main-board with power supply, conventional groups, control inputs, control groups and relay groups. Wired ready for operation. Operating manual and configuration instructions in German and English, log book, mounting materia
Spare key 911745

Not included in delivery

Input module IUX 760 M-I 908531
Batteries 2 x 12 V DC 2.3 Ah 4003368

Approvals / marking



FM3010:2014



Fire detection and suppression control panels

Small control panels

Fire alarm panel SOLID MTP Machine Tool Protection Configuration 1



Application

Use as single zone fire detection and suppression control panel for object protection.

Technical specifications

Mains voltage	115 V / 230 V AC -10% +15%
Mains frequency	50 Hz - 60 Hz
Operating voltage	19.6 V - 28.7 V DC
Power supply unit	19.6 V - 28.7 V DC / 3 A
Quiescent current	80 mA
Battery capacity	2 x 12 V / 2.2 Ah internal
Nominal output voltage	24 V DC
Output current max.	2.4 A
External control voltage	19.6 V - 28.7 V DC
Collective relays	1 fire, 1 fault, 1 operation in each case
Contact load	1 x 1 A / 30 V DC and 3 x 2 A / 230 V AC
Max. switching capacity	1 x 30 VA / 3 x 460 VA
Ambient temperature	-5 °C to +50 °C (+23 °F to +122 °F)
Storage temperature	-20 °C to +65 °C (-4 °F to +149 °F)
Relative humidity	max. 90 % no condensation
Dimensions	340 x 300 x 140 mm (WxHxD) 13.4 x 11.8 x 5.5 inch (WxHxD)
Enclosure	Polycarbonate
IP rating	IP 66
Color	RAL 7035
Weight	approx. 4.2 kg (9.3 lbs) without batteries
Mounting	Wall-mounted installation
Performance Level in acc. with ISO 13849	. d

Part no.: 929021

Small control panel of the SOLID control panel family in a wall housing. For operation of flame and heat detectors in industrial design and for monitored triggering of alarm devices, solenoid valves and release devices. Explicit LED notification and group specific control units allow a quick and intuitive control of the panel.

Product features

- One detector group for flame detectors
- One detector group for heat detectors
- One detector group for triggering the extinguishing system manually
- One control input for monitoring the fault signal of a detector
- One control input for the electrical blocking of the extinguishing system
- One control input for monitoring extinguishing agents
- One control input for audible/optical notification devices
- One control unit for valve control
- One relay 24 V DC for signal transmission (fire)
- Three 230 V AC relays for signal transmission (fire, fault, operational state)
- One internal contact group for actuation of an input module IUX 760 M-I for condition transmission (fire, fault) via Loop AP XP to a superordinated control panel
- Collective and individual LEDs, partly red/yellow

Included in delivery

Control panel with display and operating front panel, main-board with power supply, conventional groups, control inputs, control groups and relay groups. Wired ready for operation. Operating manual and configuration instructions in German and English, log book, mounting material

Spare key 911745

Not included in delivery

Input module IUX 760 M-I 908531
Batteries 2 x 12 V DC 2.3 4003368

Approvals / marking



EN54-2, EN54-4
1725-CPR-E0008



Fire detection and suppression control panels

Small control panels

Fire alarm panel SOLID CFS Clean Fire Suppression Configuration 1



Application

Use as fire detection and extinguishing control panel in special extinguishing systems.

Technical specifications

Mains voltage	115 V / 230 V AC -10% +15%
Mains frequency	50 Hz - 60 Hz
Operating voltage	19.6 V - 28.7 V DC
Power supply unit	19.6 V - 28.7 V DC / 3 A
Quiescent current	80 mA DC
Battery capacity	2 x 12 V / 2.2 Ah internal
Nominal output voltage	24 V DC
Output current max.	2.4 A
External control voltage	19.6 V - 28.7 V DC
Collective relays	1 extinguishing system delay, 1 fire, 1 operation, 1 extinguishing
Contact load	1 x 1 A / 30 V DC 3 x 2 A / 230 V AC
Max. switching capacity	1 x 30 VA / 3 x 460 VA
Ambient temperature	-5 °C to +50 °C (+23 °F to +122 °F)
Storage temperature	-20 °C to +65 °C (-4 °F to +149 °F)
Relative humidity	max. 90 % no condensation
Dimensions	340 x 300 x 140 mm (WxHxD) 13.4 x 11.8 x 5.5 inch (WxHxD)
Enclosure	Polycarbonate
IP rating (EN 60529)	IP 66
Colour	RAL 7035
Weight	approx. 4.2 kg (9.3 lbs) without batteries
Mounting	Wall-mounted installation

Part no.: 929022

Small control panel of the SOLID control panel family in a wall housing. For operation of heat detectors, smoke detectors and multisensor detectors in standard design by different manufacturers (Apollo, System Sensor) and for monitored triggering of alarm devices, valves and release devices. Explicit LED notification and group specific control units allow a quick and intuitive operation of the panel.

Product features

- Two detector groups for fire detection through dual group dependency
- One detector group for triggering the extinguishing system manually
- One control input for monitoring mechanical blocking of the extinguishing system
- One control input for delay button
- One control input for supervision devices
- One control unit for audible notification devices
- One control unit für optical notification devices
- One control unit for valve control
- One relay 24 V DC for signal transmission (delay extinguishing system/pre-alarm)
- Three relays 230 V AC for signal transmission (fire, operating state state, triggering of extinguishing system)
- One internal contact group for actuation of an input module IUX 760 M-I for condition transmission (fire, fault) via Loop to a superordinated control panel
- Collective and individual LEDs, partly red/yellow

Included in delivery

Control panel with display and operating front panel, main-board with power supply, conventional groups, control inputs, control groups and relay groups. Wired ready for operation. Operating manual and configuration instructions in German and English, log book, mounting material.

Spare key 911745

Not included in delivery

Input module IUX 760 M-I 908531
Batteries 2 x 12 V DC 2.3 Ah 4003368

Approvals / Marking



EN54-2, EN54-4, EN12094-1
1725-CPR-E0009



Fire detection and suppression control panels

Small control panels

Fire alarm panel SOLID CFS VK Clean Fire Suppression Configuration 3



Application

Use as single-zone fire detection and suppression control panel in special extinguishing systems.

Technical specifications

Mains voltage	115 V / 230 V AC (97 V - 255 V AC)
Mains frequency	50 Hz - 60 Hz (47 Hz - 63 Hz)
Operating voltage	19.6 V - 28.7 V DC
Power supply unit	19.6 V - 28.7 V DC / 3 A
Quiescent current	80 mA DC
Battery capacity	2 x 12 V / 7.2 Ah internal
Nominal output voltage	24 V DC
Output current max.	2.4 A
External control voltage	19.6 V - 28.7 V DC
Collective relays	per 1 monitoring alarm 1 fire, 1 operation, 1 alarm/extinguishing
Contact load	1 x 1 A / 30 V DC 3 x 2 A / 230 V AC
Max. switching capacity	1 x 30 VA / 3 x 460 VA
Ambient temperature	-5 °C to +50 °C (+23 °F to +122 °F)
Storage temperature	-20 °C to +65 °C (-4 °F to +149 °F)
Relative humidity	max. 90 % no condensation
Dimensions	340 x 300 x 190 mm (WxHxD) 13.4 x 11.8 x 7.5 inch (WxHxD)
IP rating (EN 60529)	IP 66
Enclosure	Polycarbonate
Color	RAL 7035
Weight	approx. 4.7 kg (10.4 lbs) without batteries
Mounting	Wall-mounted installation

Part no.: 929217

Small control panel of the SOLID control panel family in a wall housing. For operation of heat detectors, smoke detectors and multisensor detectors in standard design by different manufacturers (Apollo, System Sensor) and for monitored triggering of alarm devices, valves and release devices. Explicit LED notification and group specific control units allow a quick and intuitive operation of the panel.

Product features

- Two detector groups for fire detection through dual group dependency
- One detector group for triggering the extinguishing system manually
- One control input for abort button
- One control input for determining the extinguishing medium flow
- One control input for system monitoring, e.g. extinguishing agent loss
- One control unit for notification devices starting from evacuation alarm
- One control group for notification devices extinguishing system triggered
- One control unit for release device
- One relay 24 V DC for signal transmission monitoring alarm
- Three relays 230 V AC for signal transmission (fire, operation, pre-alarm / extinguishing system triggered)
- One internal contact group for actuation of an Input unit IUX 765 M-I for condition transmission (fire, fault) via Loop AP XP to a superordinated Clunid control panel
- Collective and individual LEDs, partly red/yellow

Included in delivery

Control panel with display and operating front panel, main-board with power supply unit, conventional groups, control inputs, control groups and relay groups. Wired ready for operation.

Operating manual and configuration instructions in German and English, log book, mounting material.

Spare key

911745

Not included in delivery

Input Unit IUX 765 M-I

4000954

Batteries 2 x 12 V DC 7.2 Ah

927122

Approvals / Marking



FM3010:2014



Fire detection and suppression control panels FMZ 5000

Additional and alternative components of the FMZ 5000 mod S

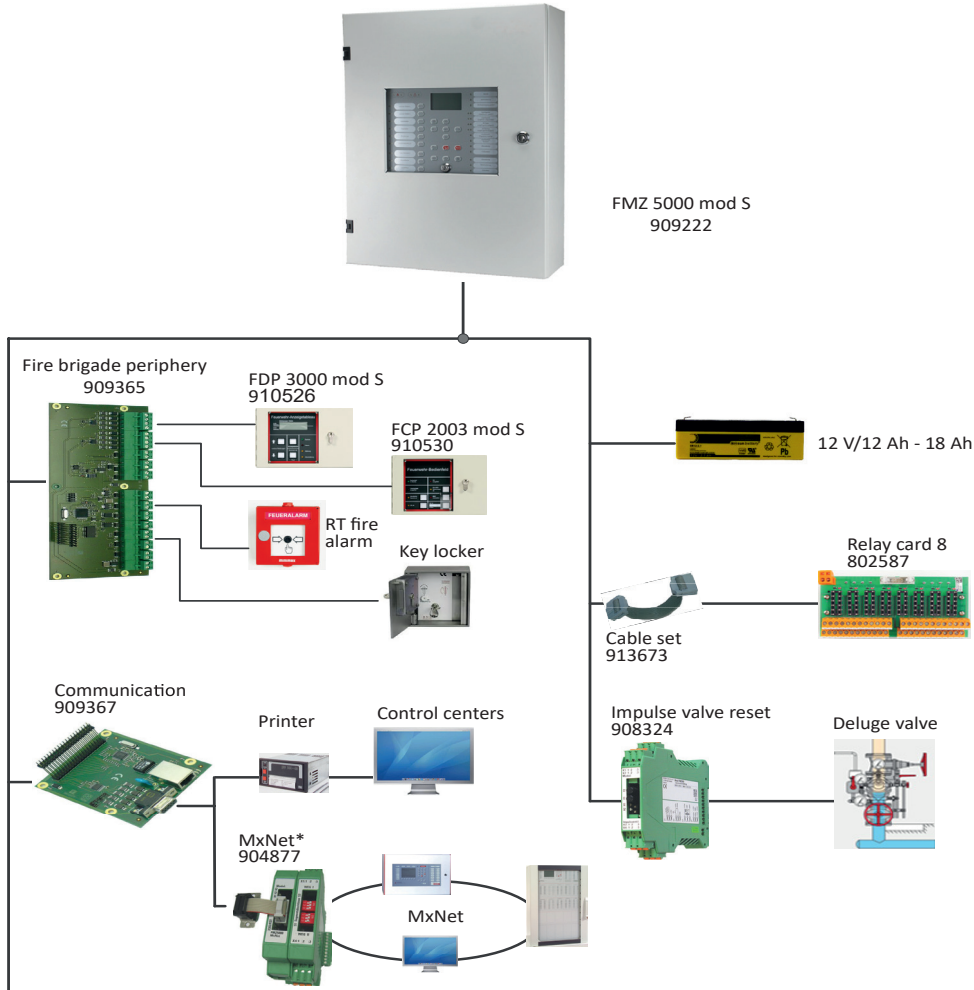

* Available on request



Fire detection and suppression control panels

FMZ 5000

Fire alarm panel FMZ 5000 mod S



Application

Use as fire detection and suppression control panel in single-zone water or gas extinguishing systems, as spark detection and spark extinguishing control panel as well as in applications with undelayed fire detection, such as for the protection of machines or paint shops.

Technical specifications

Mains voltage	115 V / 230 V AC -10% +15%
Mains frequency	50 Hz - 60 Hz
Operating voltage	26.5 V DC
Power supply unit	26.5 V DC / 3 A
Quiescent current	approx. 250 mA
Battery capacity	2 x 12 V / 12 Ah or 2 x 12 V / 18 Ah
External control voltage	26.5 V DC
Collective relays	Fire / fault in each case
Contact load	1 A / 30 V DC, 0.5 A / 125 V AC
Max. switching capacity	30 W / 62.5 VA
Ambient temperature	-5 °C to +55 °C (+23 °F to +131 °F)
Storage temperature	-20 °C to +55 °C (-4 °F to +131 °F)
Relative humidity (IEC 721-3-3)	max. 95 % no condensation
Enclosure	Sheet steel
Dimensions approx. body	440 x 595 x 171 mm (WxHxD) 17.3 x 23.4 x 6.7 inch (WxHxD)
IP rating (EN 60529)	IP 54
Color	RAL 7035
Weight	approx. 13.2 kg (29.1 lbs) without batteries
Mounting	Wall-mounted installation

Approvals / marking

G 211052
G 2111230786-CPD-21081
0786-CPD-21136

APPROVED

Part no.: 909222

Compact control panel of the FMZ 5000 control panel family accommodated in a wall housing. For operation of conventional detectors in standard design or suitable for industrial applications and for the monitored triggering of alarm devices, valves and release devices.

Optional modules allow the additional connection and operation of:

- Two transmission devices for fire and fault, one fire brigade control panel, fire brigade display panel and fire brigade key deposit box
- Interfaces for the data transfer to management systems, printer, control panel networks and remote diagnostics
- Test of installed spark detectors during operation
- Relay card RK8 or RK8TQ

Product features

- 6 detector groups for any type of conventional detectors, there of 4 for undelayed fire detection
- 3 control groups
- 8 open collector outputs for connecting relays
- Collective and individual LEDs, partly red/yellow
- Extendable by function modules
 - Fire brigade periphery for connection of all kind of fire brigade components
 - Communication card for connection to external control facilities and printers
 - Spark test card for connection of spark test detectors for testing spark detectors
- Suitable for integration into a ring network with further Minimax control panels
- Large fully graphic LC display with menu navigation
- Key switch as access to the direct operation of detector and control groups

Included in delivery

Control panel with display and operating front panel, mainboard with power supply, conventional groups, control groups and open collector outputs, wired ready for operation.

Operating manual, mounting material

Key, switch

911745

Key, door

767588

Not included in delivery

Relay card RK8

802587

RK8TQ

800843

Cable set FMZ 5000 mod S

913673

Batteries 2 x 12 V / 12 Ah

927481

Batteries 2 x 12 V / 18 Ah

927123

Installation material, functional modules



Fire detection and extinguishing control panels

FMZ 5000

Fire alarm panel FMZ 5000 mod S SUZ

Part no.: 918077

Fully programmed monitoring control panel for 6 detector groups. Components of sprinkler system as pressure switches, temperature switches, limit switches and level switches can be connected to the control panel.

Optional relay card RK8TQ or RK8 from the accessory range. Customer made labelling is possible on request.

Application

Use as monitoring panel for sprinkler systems.

Product features

- 6 detector groups for monitoring sprinkler systems
- 8 open collector outputs for connecting relays
- Collective and individual LEDs, yellow
- Large fully graphic LC display with menu navigation
- Key switch as access to the direct operation of detector and control groups

Technical specifications

Mains voltage	115 V / 230 V AC -10% +15%
Mains frequency	50 Hz - 60 Hz
Operating voltage	26.5 V DC
Power supply unit	26.5 V DC / 3 A
Quiescent current	approx. 250 mA
Battery capacity	12 Ah/30h and 18 Ah/72h
External control voltage	26.5 V DC
Collective relays	fault in each case
Contact load	1 A / 30 V DC, 0.5 A / 125 V AC
Max. switching capacity	30 W / 62.5 VA
Ambient temperature	-5 °C to +40 °C (+23 °F to +104 °F)
Relative humidity (IEC 721-3-3)	max. 95 % no condensation
Enclosure	Sheet steel
Dimensions approx. body	440 x 595 x 171 mm (WxHxD) 17.3 x 23.4 x 6.7 inch (WxHxD)
IP rating (EN 60529)	IP 54
Color	RAL 7035
Weight	approx. 12.6 kg (27.8 lbs) without batteries
Mounting	Wall-mounted installation

Included in delivery

Control panel with display and operating front panel, mainboard with power supply, conventional groups, control groups and open collector outputs, wired ready for operation. Operating manual, log book, mounting material, connection diagram.

Key, switch front panel	911745
Key, switch door	767588
2 Batteries 12V/12Ah	761677

Not included in delivery

Relay card	RK8	802587
	RK8TQ	800843
Cable set FMZ 5000 mod S for RK8TQ and RK8		913673
Installation material:		
Limit switch	black	880214
	red	790400
Pressure switch	PMÜ-3	792183
	PMÜ-10	810564
Float switch for:		
Monitoring of liquids as air water pressure vessel,		879475
open water storage tank		
Monitoring of pump house		842358

Approvals / marking

G 211052
G 2111230786-CPD-21081
0786-CPD-21136



Fire detection and suppression control panels

FMZ 5000

Fire alarm panel FMZ 5000 mod S SZ



Application

Use as fire detection and suppression control panel in single-zone special extinguishing systems.

Technical specifications

Mains voltage	115 V / 230 V AC -10% +15%
Mains frequency	50 Hz - 60 Hz
Operating voltage	26.5 V DC
Power supply unit	26.5 V DC / 3 A
Quiescent current	approx. 250 mA
Battery capacity	2 x 12 V / 12 Ah or 2 x 12 V / 18 Ah internal
Nom. output voltage	26.5 V DC
Max. output current	3 A
Collective relays	Fire / fault in each case
Contact load	1 A / 30 V DC, 0.5 A / 125 V AC
Max. switching capacity	30 W / 62.5 VA
Ambient temperature	-5 °C to +55 °C (+23 °F to +131 °F)
Storage temperature	-20 ° to +65 °C (-4 °F to 149 °F)
Relative humidity (IEC 721-3-3)	max. 95 % no condensation
Enclosure	Sheet steel
Dimensions approx. body	440 x 595 x 171 mm (WxHxD) 17.3 x 23.4 x 6.7 inch (WxHxD)
IP rating (EN 60529)	IP 54
Color	RAL 7035
Weight	approx. 13.2 kg (29.1 lbs) without batteries
Mounting	Wall-mounted installation

Approvals / marking



G 211052
G 211123



0786-CPD-21081
0786-CPD-21136



Part no.: 927645

Compact control panel of the FMZ 5000 control panel family accommodated in a wall housing. For operation of conventional detectors in standard or industrial design (configuration required) and for the monitored triggering of alarm devices, valves and release devices.

Optional modules allow the additional connection and operation of:

- Two transmission devices for fire and fault, one fire brigade control panel, fire brigade display panel and fire brigade key deposit box
- Interfaces for the data transfer to management systems, printer, control panel networks and remote diagnostics
- Relay card RK8 or RK8TQ

Product features

- 2 detector groups for fire detection through dual group dependency
- 1 detector group for triggering the extinguishing system manually
- 1 detector group for monitoring mechanical blocking of the extinguishing system
- 1 detector group for revision contact and monitoring of a temperature switch
- 1 detector group for monitoring field components
- 1 control group for audible signaling device
- 1 control group for optical signaling device
- 1 control group for solenoid valves
- 8 open collector outputs for connecting relays
- Collective and individual LEDs, partly red/yellow
- Extendable by functional modules
 - Fire brigade periphery for connection of all kind of fire brigade components
 - Communication card for connection to external control facilities and printers
- Large fully graphic LC display with menu navigation
- Key switch as access to the direct operation of detector and control groups

Included in delivery

Control panel with display and operating front panel, mainboard with power supply, conventional groups, control groups and open collector outputs, wired ready for operation. Operating manual, log book, mounting material

Key, switch 911745
Key, door 767588

Not included in delivery

Relay card RK8 802587
RK8TQ 800843
Cable set FMZ 5000 mod S 913673
Batteries 2 x 12 V / 12 Ah 927481
Batteries 2 x 12 V / 18 Ah 927123
Installation material, functional modules



Fire detection and suppression control panels

FMZ 5000

Fire alarm panel FMZ 5000 mod S VK



Application

Use as fire detection and suppression control panel in single-zone water or special extinguishing systems and in all applications with instantaneous fire detection e.g. machine or object protection.

Technical specifications

Mains voltage	115 V / 230 V AC -10% +15%
Mains frequency	50 Hz - 60 Hz
Operating voltage	26.5 V DC
Power supply unit	26.5 V DC / 3 A
Quiescent current	approx. 250 mA
Battery capacity	2 x 12 V / 12 Ah or 2 x 12 V / 18 Ah internal
Nom. output voltage	26.5 V DC
Max. output current	3 A
Collective relays	Fire / fault in each case
Contact load	1 A / 30 V DC, 0.5 A / 125 V AC
Max. switching capacity	30 W / 62.5 VA
Ambient temperature	-5 °C to +55 °C (+23 °F to +131 °F)
Storage temperature	-20 ° to +65 °C (-4 °F to 149 °F)
Relative humidity (IEC 721-3-3)	max. 95 % no condensation
Enclosure	Sheet steel
Dimensions approx. body	440 x 595 x 171 mm (WxHxD) 17.3 x 23.4 x 6.7 inch (WxHxD)
IP rating (EN 60529)	IP 54
Color	RAL 7035
Weight	approx. 13.2 kg (29.1 lbs) without batteries
Mounting	Wall-mounted installation

Part no.:929519

Compact control panel of the FMZ 5000 control panel series accommodated in a wall housing. For operation of conventional detectors in standard or industrial design and for the monitored triggering of alarm devices, valves and release devices.

Optional modules allow the additional connection and operation of:

- Interfaces for data transmission to management systems, printers, central networking and remote diagnosis
- Relay card RK8 or RK8TQ

Product features

- 6 detector groups for any type of conventional detectors, 4 of which for instantaneous fire detection
- 3 control groups
- 8 open collector outputs for connection of relays
- Collective and individual LEDs, partly red/yellow
- Extendable by functional module communication for connection to external control facilities and printers
- Large fully graphic LC display with menu navigation
- Key switch as access to the direct operation of detector and control groups
- 24 V DC stable control output for safe control of solenoid valves and other external loads

Included in delivery

Control panel with display and operating front panel, main-board with power supply, conventional groups, control groups and open collector outputs, wired ready for operation. Operating manual, mounting material.

Key, switch	911745
Key, door	767588

Not included in delivery

Relay card RK8	802587
RK8TQ	800843
Cable set FMZ 5000 mod S	913673
Batteries 12 V/12 Ah	927481
Batteries 12 V/18 Ah	927123
Installation material, functional modules	

Note

This fire detection and suppression control panel is FM approved only and has to be configured to customer specifications.

Approvals / marking





Fire detection and suppression control panels

Modules/cards

FMZ 5000 mod S communication card

Part no.: 909367

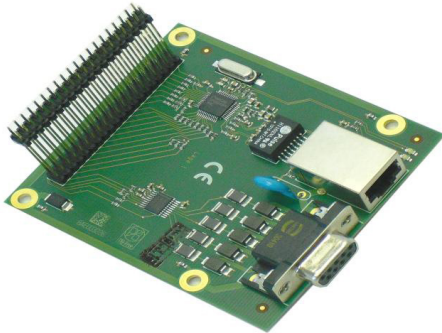

Function module for installation into a FMZ 5000 mod S with data interfaces for communication with other devices or networking with other control panels. One interface corresponds to the RS-232 standard with freely configurable interface parameters.

Product features

- RS-232 interface with 9-pole Sub-D female connector
- The interface parameters are adjustable through configuration
- For both interfaces, data transfer is also possible by means of converters via fiber optic cables

Application

- Interface for data communication and message transmission.
- Data transfer to PCs or control centers via Mx2 protocol
- Connection of a printer for printout and logging messages and statuses. Printer types selectable through configuration
- Connection of a module FMZ 5000 MxNet for integrating the FMZ 5000 mod S in the path-redundant control panel MxNet ring network

Technische Daten

Operating voltage	26.7 V DC
Quiescent current	(Ethernet on) 10 mA DC (Ethernet off) 30 mA DC
Data interfaces	1 RS-232
Ambient temperature	-5 °C to +40 °C (+23 °F to +104 °F)
Relative humidity	max. 95 % no condensation
Mounting	On the mainboard rear side
Weight	46 g (0.1 lbs)
Dimensions	75 x 82 x 40 mm (WxLxD) 3 x 3.2 x 1.6 inch (WxLxD)

Included in delivery

Module ready for installation including fastening material.

Not included in delivery

Cable connector and connecting cables for the data line.

Note

Data cable for RS-232 interface, max. length 10 m. Use converters for longer cables. Select the cable type according to the cable length and the intended purpose. One communication module can be installed into each Control panel.

Approvals / marking

See panels



Fire detection and suppression control panels

Modules/cards

FMZ 5000 mod S card fire brigade periphery

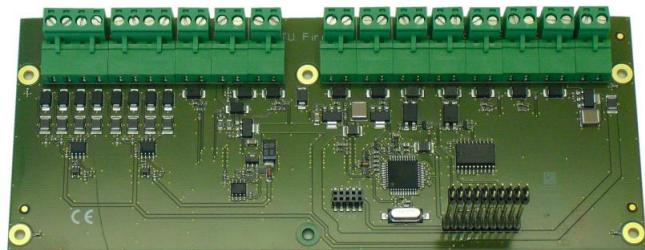

Part no.: 909365

Function module for installation into an FMZ 5000 mod S with all interfaces for connecting components to call and inform the fire brigade, for the control panel operation by the fire brigade as well as for the non-violent access to the object via the key deposit.

Functions and connections comply with DIN 14675, DIN 14661, DIN 14662, and VdS 2350.

Product features

- One RS-422 interface for connecting a fire brigade control panel with serial data transfer
- One RS-422 interface for connecting a fire brigade display panel with serial data transfer
- Trigger interface for fire brigade key deposit box adapter (FSD) with triggering of the door opening as well as monitoring of door contact and tamper-proof line
- Trigger interface for the transmission device fire
- Trigger interface for the transmission device control

Application

For triggering and monitoring all fire brigade components, such as:

- One transmission device for fire and one for fault messages
- Connection of one serial fire brigade control panel and display panel
- One adapter for connecting a fire brigade key deposit box

Technical specifications

Operating voltage	26.7 V DC
Quiescent current	30 mA DC
Data interfaces	2 RS-422
Component interfaces	Connection transmission device fire, fault, FSD adapter
Ambient temperature	-5 °C to +40 °C (+23 °F to +104 °F)
Relative humidity (IEC 721-3-3)	max. 95 % no condensation
Mounting	On the mainboard rear side
Weight	139 g (0.3 lbs)
Dimensions	208 x 83 x 40 mm (WxLxH) 8.2 x 3.3 x 1.6 inch (WxLxH)

Included in delivery

Module ready for installation including fastening material.

Not included in delivery

Connecting lines and data cable.

Note

Data cable for RS-422 interface, max. length 1000 m. Use converters for longer cables. Select the cable type according to the cable length and intended purpose. One fire brigade interface module can be installed in each control panel.

Approvals / marking

See panels



Fire detection and suppression control panels FMZ 5000

Additional and alternative components of the FMZ 5000

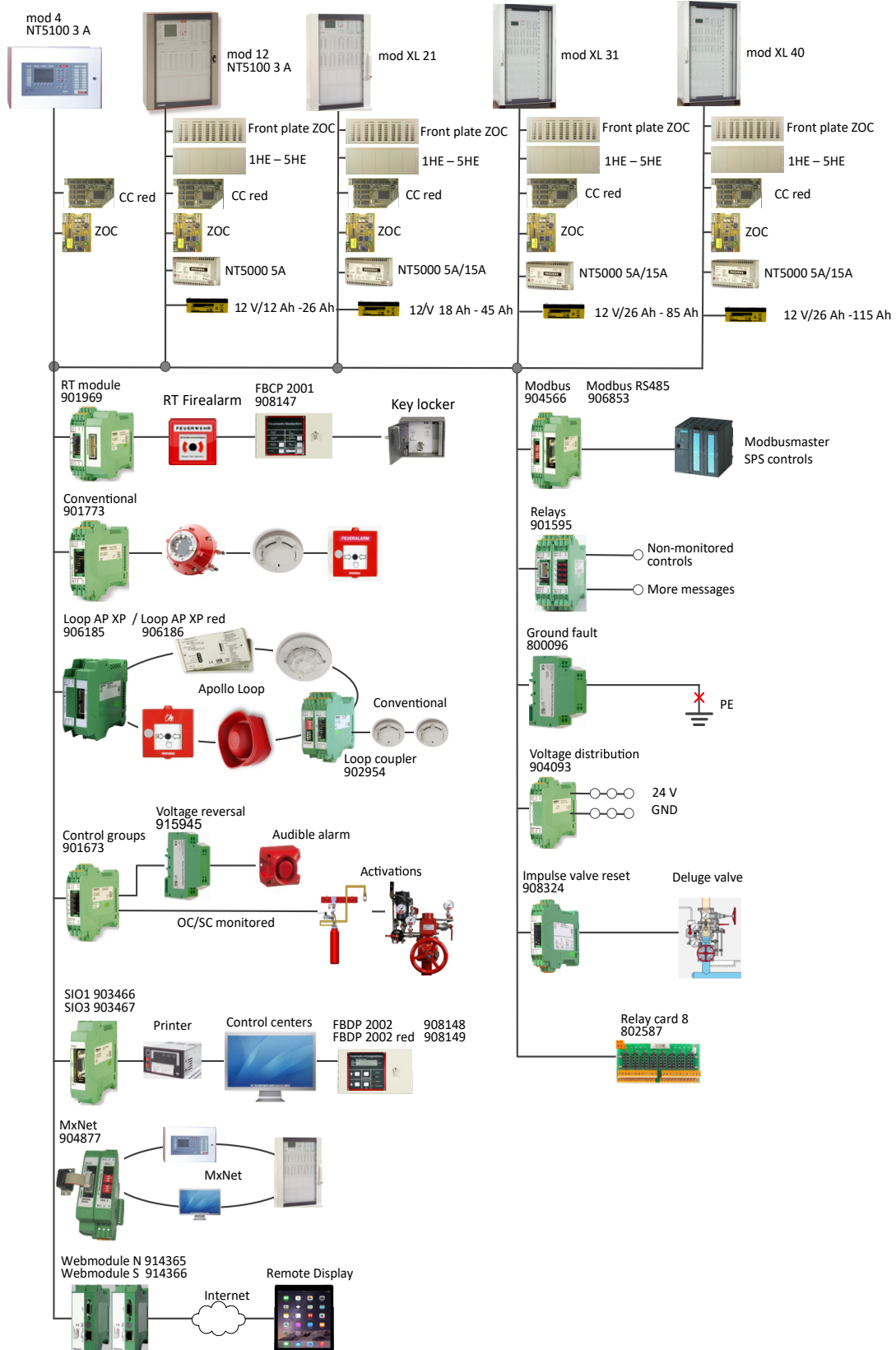

301-010_002 / A/04 / 2021-Nov-22 / en
The contents of this publication are subject to modifications without notice. All rights reserved.
1/1

Trusted above all.

Viking GmbH | Industriestr. 10/12 | D-23840 Bad Oldesloe | www.viking-emea.com





Fire detection and suppression control panels

FMZ 5000 complete OU

Fire alarm panel FMZ 5000 mod 4 L GW

Part no.: 908593

Compact fire alarm panel of the fire alarm panel range FMZ 5000. Equipped and ready for fire detection in conventional technology for a maximum of 128 detectors, monitoring and control of a single-zone extinguishing system. Signal indication through large LC display and LEDs, menu-guided operation using configurable function keys.

Application

For use as fire alarm and extinguishing control panel in single-zone extinguishing systems.

Technical specifications

Mains voltage	115 V / 230 V AC ±15%
Mains frequency	50 Hz - 60 Hz
Operating voltage	21 V - 27.2 V DC
Power supply unit	24 V DC / 3 A
Quiescent current	approx. 225 mA
Battery capacity	2 x 12 V / 12 Ah
External control voltage	21 V - 27.2 V DC
Contact load	1 A / 30 V DC, 0.5 A / 125 V AC
Max. switching capacity	30 W / 62.5 VA
Ambient temperature	-5°C to +40°C (+23 °F to +104 °F)
Relative humidity	max. 95 % no condensation
Enclosure	Sheet steel 4U
Dimensions	475 x 340 x 200 mm (WxHxD) 18.7 x 13.4 x 7.9 inch (WxHxD) Length mounting rail 1 x 213 mm (8.4 inch)
IP rating (EN 60529)	IP 54
Specification according to	EN 54-2 A1: 2006 EN 54-4 A2: 2006 EN 12094-1: 2003
Color	RAL 7035
Weight	approx. 20 kg (44.1 lbs) with batteries and modules
Mounting	Wall-mounted installation

Product features

- Expansion of the fire alarm panel is designed for controlling a single-zone extinguishing system
- 4 conventional detector lines, 4 control groups, 8 relays with 1 potential-free changeover contact each
- Collective signal LED and individual LED pairs, red/yellow, for status indications
- Large LC display, fully graphical with menu-driven operation
- Emergency power batteries 12 Ah
- The fire alarm is completely preconfigured and ready for operation

Included in delivery

Fire alarm panel with front display and operating plate, central card and power supply unit, and one conventional detector module, control group module and relay module each as well as a zone operating panel card. 2 x 12 Ah batteries.

Wired ready for operation and preconfigured.

Operating instructions, terminal assignment, installation manual, drilling template.

Approvals / marking



G 204124
G 205019



0786-CPD-20843
0786-CPD-20222





Fire detection and suppression control panels

FMZ 5000

Fire alarm panel FMZ 5000 mod 4 NT5100 3A



Application

For use for sole fire detection control or combined fire detection and extinguishing control in small-scale projects. Also for controlling multi-zone extinguishing systems through redundant hardware.

Technical specifications

Mains voltage	115 V / 230 V AC \pm 15%
Mains frequency	50 Hz - 60 Hz
Operating voltage	nom. 24 V DC min. 21 V DC max. 27.2 - 29 V DC
Power supply unit	24 V DC / 1,5 or 3 A
Quiescent current	approx. 120 mA DC
Battery	2 x 12 V / 12 Ah internal
External control voltage	min. 21 V DC max. 27.2 - 29 V DC
Ambient temperature	-5°C to +40°C (+23 °F to +104 °F)
Relative humidity (IEC 721-3-3)	max. 95 % no condensation
Enclosure	Sheet steel 4U
Dimensions	475 x 340 x 200 mm (WxHxD) 18.7 x 13.4 x 7.9 inch (WxHxD) Length of mounting rail 1 x 213 mm (8.4 inch) usable mounting rail length for function modules 1 x 160 mm (6.3 inch)
IP rating (EN 60529)	IP 54
Color	RAL 7035
Weight	approx. 15 kg (33.1 lbs) without modules
Mounting	Wall-mounted installation

Part no.: 908551

Smallest base unit in the modular fire alarm panel range FMZ 5000. The wall enclosure is also suitable for flush-mounted wall installation or for desk mounting. For connecting analogue addressable detectors and conventional detectors in standard or industrial design. Activation of remote transmission units for fire and fault signals, data transfer to management systems and control stations with open interfaces. Signal indication through large LC display and LEDs, menu-guided operation using configurable function keys.

Product features

- Free selection of functional modules to be used for all project tasks
- Can also be expanded for control of multi-zone extinguishing systems with redundant hardware
- Up to 4 detector loops with 126 detectors each, 16 conventional detector lines for 32 detectors of any design each
- Up to 16 control groups and 32 relays
- 14 collective signal LEDs, some in two colours, 16 LED pairs, red/yellow, for individual signal indications
- Large LC display, fully graphical with menu-guided operation
- Can be loop networked up to 32 units in total
- The enclosure has space for emergency power batteries up to 12 Ah
- All settings are carried out via a fully graphical interface on a PC with the MxSysCon configuration program

Included in delivery

Fire alarm panel with front display, operating plate, central card and power supply unit. Wired ready for the insertion of any modules. No additional wiring in the fire alarm panel required. Operating instructions, installation manual, drilling template.

Not included in delivery

Modules, zone operating panel cards, batteries, report printer, installation material

Note

Order batteries separately. Alternative batteries must be selected according to the table at the end of the chapter.

Approvals / marking

(depending on power supply unit)



G 204124
G 205019



0786-CPD-20843
0786-CPD-20222





Fire detection and suppression control panels

FMZ 5000

Fire alarm panel FMZ 5000 mod 4



Application

For use for sole fire detection control or combined fire detection and extinguishing control in small-scale projects. Also for controlling multi-zone extinguishing systems through redundant hardware.

Technical specifications

Mains voltage	115 V / 230 V AC -15%, +10%
Mains frequency	50 Hz - 60 Hz
Operating voltage	19.5 V - 29 V DC
Power supply unit	24 V DC / 1.5 A
Quiescent current	approx. 120 mA DC
Battery	2 x 12 V / 12 Ah internal
External control voltage	21 V - 29.6 V DC
Ambient temperature	-5°C to +40°C (+23 °F to +104 °F)
Relative humidity (IEC 721-3-3)	max. 95 % no condensation
Enclosure	Sheet steel 4U
Dimensions	475 x 340 x 200 mm (WxHxD) 18.7 x 13.4 x 7.9 inch (WxHxD) Length of mounting rail 1 x 213 mm (8.4 inch) usable mounting rail length for function modules 1 x 160 mm (6.3 inch)
IP rating (EN 60529)	IP 54
Color	RAL 7035
Weight	approx. 15 kg (33.1 lbs) without modules
Mounting	Wall-mounted installation

Part no.: 905231

Smallest base unit in the modular fire alarm panel range FMZ 5000. The wall enclosure is also suitable for flush-mounted wall installation or for desk mounting. For connecting analogue addressable detectors and conventional detectors in standard or industrial design. Activation of remote transmission units for fire and fault signals, data transfer to management systems and control stations with open interfaces. Signal indication through large LC display and LEDs, menu-guided operation using configurable function keys.

Product features

- Free selection of functional modules to be used for all project tasks
- Can also be expanded for controlling multi-zone extinguishing systems with redundant modules
- Up to 4 detector loops with 126 detectors each, 16 conventional detector lines for 32 detectors of any design each
- Up to 16 control groups and 32 relays
- 14 collective signal LEDs, some in two colours, 16 LED pairs, red/yellow, for individual signal indications
- Large LC display, fully graphical with menu-guided operation
- Can be loop networked up to 32 units in total
- The enclosure has space for emergency power batteries up to 12 Ah
- All settings are carried out via a full graphical interface on a PC with the MxSysCon configuration program

Included in delivery

Fire alarm panel with front display, operating plate, central card and power supply unit. Wired ready for the insertion of any modules. No additional wiring in the fire alarm panel required. Operating instructions, operator's log, installation manual, drilling template.

Not included in delivery

Modules, zone operating panel cards, batteries, report printer, installation material.

Note

Order batteries separately.

Approvals / marking





Fire detection and suppression control panels

FMZ 5000

Fire alarm panel FMZ 5000 mod 12 NT5100 3A



Application

For use for sole fire detection control or combined fire detection and extinguishing control in medium-scale projects. Also for controlling of multi-zone extinguishing systems through redundant hardware.

Technical specifications

Mains voltage	115 V / 230 V AC \pm 15%
Mains frequency	50 Hz - 60 Hz
Operating voltage	nom. 24 V DC min. 21 V DC max. 27.2 - 29 V DC
Power supply unit	2.7 / 3 / 5 / 15 A 24 V DC
Quiescent current	approx. 120 mA DC
Battery	2 x 12 V
External control voltage	min. 21 V DC max. 27.2 - 29 V DC
Ambient temperature	-5°C to +40°C (+23 °F to +104 °F)
Relative humidity (IEC 721-3-3)	max. 95 % no condensation
Enclosure	Sheet steel 12U
Dimensions	600 x 604 x 225 mm (WxHxD) 23.6 x 23.8 x 8.9 inch (WxHxD) Length of mounting rail 3 x 325 mm (12.8 inch) usable mounting rail length for function modules 3 x 270 mm (10.6 inch)
IP rating (EN 60529)	IP 54
Color	RAL 7035
Weight	Approx. 26 kg (57.3 lbs) without modules
Mounting	Wall-mounted installation

Part no.: 908563

Medium-size base unit from the fire alarm panel range FMZ 5000. 19" wall enclosure with front door in stainless steel colored frame. For connecting analogue addressable detectors and conventional detectors in standard or industrial design. Activation of remote transmission units for fire and fault signals, data transfer to management systems and control stations with open interfaces. Signal indication through large LC display and LEDs, menu-guided operation using function keys.

Product features

- Free selection of functional modules to be used for all project tasks
- Can also be expanded for controlling multi-zone extinguishing systems with redundant modules
- Up to 28 detector loops with 126 detectors each, 176 conventional detector lines for 32 detectors of any design each
- Up to 176 control groups and 176 relays
- 14 collective signal LEDs, some in two colours, max. 192 LED pairs, red/yellow, for signal indications
- Large LC display, fully graphical with menu-guided operation
- Can be loop networked up to 32 units
- The enclosure has space for emergency power batteries up to 18 Ah
- All settings are defined via a fully graphical interface on a PC with the MxSysCon configuration program

Included in delivery

Fire alarm panel with front display, operating plate, control card and power supply unit. Wired ready for insertion of any modules. No additional wiring in the fire alarm panel is required. Operating instructions, installation manual, drilling template.

Additional expanded models upon request.

Not included in delivery

Cableset FMZ 5000 module 904101
Modules, zone operating panel cards, front plate BBF, dummy plates, batteries, report printer, installation material.

Note

Alternative power supply units and batteries must be selected according to the table at the end of the chapter. Order batteries separately.

Approvals / marking

(depending on power supply unit)



G 204124
G 205019



0786-CPD-20843
0786-CPD-20222





Fire detection and suppression control panels

FMZ 5000 base unit

Fire alarm panel FMZ 5000 mod 12 NT5000 5A



Application

For use for sole fire detection control or combined fire detection and extinguishing control in medium-scale projects. Also for controlling of multi-zone extinguishing systems through redundant hardware.

Technical specifications

Mains voltage	115 V / 230 V AC -15%, +10%
Mains frequency	50 Hz - 60 Hz
Operating voltage	21 V - 29 V DC
Power supply unit	24 V DC / 5 A
Quiescent current	approx. 120 mA DC
Battery	2 x 12 V / 18 Ah internal
External control voltage	21 V - 29 V DC
Ambient temperature	-5°C to +40°C (+23 °F to +104 °F)
Relative humidity (IEC 721-3-3)	max. 95 % no condensation
Enclosure	Sheet steel 12U
Dimensions	600 x 604 x 225 mm (WxHxD) 23.6 x 23.8 x 8.9 inch (WxHxD) Length of mounting rail 3 x 325 mm (12.8 inch) usable mounting rail length for function modules 2 x 270 mm (10.6 inch), 1 x 170 mm (6.7 inch)
IP rating (EN 60529)	IP 54
Specification according to	EN 54-2 A1:2006 EN 54-4 A2:2006 EN 12094-1:2003
Color	RAL 7035
Weight	Approx. 26 kg (57.3 lbs) without modules
Mounting	Wall-mounted installation

Part no.: 920643

Medium-size base unit from the fire alarm panel range FMZ 5000. 19" wall enclosure with front door in stainless steel colored frame. For connecting analogue addressable detectors and conventional detectors in standard or industrial design. Activation of remote transmission units for fire and fault signals, data transfer to management systems and control stations with open interfaces. Signal indication through large LC display and LEDs, menu-guided operation using function keys.

Product features

- Free selection of functional modules to be used for all project tasks
- Can also be expanded for controlling multi-zone extinguishing systems with redundant modules
- Up to 28 detector loops with 126 detectors each, 176 conventional detector lines for 32 detectors of any design each
- Up to 176 control groups and 176 relays
- 14 collective signal LEDs, some in two colours, max. 192 LED pairs, red/yellow, for signal indications
- Large LC display, fully graphical with menu-guided operation
- Can be loop networked up to 32 units
- The enclosure has space for emergency power batteries up to 18 Ah
- All settings are defined via a fully graphical interface on a PC with the MxSysCon configuration program

Included in delivery

Fire alarm panel with front display, operating plate, control card and power supply unit. Wired ready for insertion of any modules. No additional wiring in the fire alarm panel is required. Operating instructions, installation manual, drilling template.

Additional expanded models upon request.

Not included in delivery

Cable set FMZ 5000 module 904101
Modules, zone operating panel cards, front plate BBF, dummy plates, batteries, report printer, installation material.

Note

Alternative power supply units and batteries must be selected according to the table at the end of the chapter. Order batteries separately.

Approvals / marking



G 204124
G 205019



0786-CPD-20843
0786-CPD-20222





Fire detection and suppression control panels

FMZ 5000

Fire alarm panel FMZ 5000 mod 12 BMA AP



Application

For use as fire detection panel with optional extension possibilities.

Technical specifications

Mains voltage	115 V / 230 V AC -15%, +10%
Mains frequency	50 Hz - 60 Hz
Operating voltage	21 V - 29 V DC
Power supply unit	24 V DC / 5 A
Quiescent current	approx. 340 mA DC
Battery	2 x 12 V / 26 Ah internal
External control voltage	21 V - 29 V DC
Ambient temperature	-5 °C to +40 °C (+23 °F to +104 °F)
Relative humidity (IEC 721-3-3)	max. 95 % no condensation
Enclosure	Sheet steel 12U
Dimensions	600 x 604 x 225 mm (WxHxD) 23.6 x 23.8 x 89 inch (WxHxD) Length of mounting rail 3 x 325 mm (12.8 inch)
IP rating (EN 60529)	IP 54
Specification according to	EN 54-2 A1:2006 EN 54-4 A2:2006 EN 12094-1:2003
Color	RAL 7035
Weight	approx. 51 kg (112.4 lbs) with batteries and modules
Mounting	Wall-mounted installation

Part no.: 910889

Medium-size base unit of the fire alarm panel range FMZ 5000. 19" wall enclosure with front door in stainless steel colored frame. Equipped for fire detection, monitoring and control of fired detection systems in a maximum of 512 devices in analog addressable technology and a maximum of 128 devices in conventional technology. Signal indication through large LC display and LEDs, menu-guided operation using function keys.

Product features

- Connection for remote transmission unit and fire brigade control panel (FBF)
- Expansion of the fire alarm panel is designed for controlling of one fire detection system
- 4 detector loops, 4 conventional detector lines, 4 control groups, 8 relays with 1 potential-free changeover contact each
- Collective signal LED and 32 individual LED pairs, red/yellow, for status indications
- Large LC display, fully graphical with menu-guided operation
- Emergency power batteries 26 Ah

Included in delivery

Fire alarm panel with front display and operating plate,
 1 Central card
 1 Power supply unit 5 A
 2 Loop module
 1 Remote transmission unit module
 1 Conventional detector module
 1 Control group module
 1 Relay module
 1 Power distribution module
 2 Zone operating panel cards
 2 26 Ah batteries

Wired ready for operation and preconfigured.
Operating instructions, terminal assignment, operator's log,
installation manual, drilling stencil.

Approvals / marking



G 204124
G 205019



0786-CPD-20843
0786-CPD-20222





Fire detection and suppression control panels

FMZ 5000

Fire alarm panel FMZ 5000 mod 12 LSZ AP



Application

For use as extinguishing control panel in single-zone extinguishing systems with optional extension possibilities.

Technical specifications

Mains voltage	115 V / 230 V AC -15%, +10%
Mains frequency	50 Hz - 60 Hz
Operating voltage	21 V - 29 V DC
Power supply unit	24 V DC / 5 A
Quiescent current	approx. 330 mA DC
Battery	2 x 12 V / 26 Ah internal,
External control voltage	21 V - 29 V DC
Ambient temperature	-5 °C to +40 °C (+23 °F to +104 °F)
Relative humidity (IEC 721-3-3)	max. 95 % no condensation
Enclosure	Sheet steel 12U
Dimensions	600 x 604 x 225 mm (WxHxD) 23.6 x 23.8 x 89 inch (WxHxD) Length of mounting rail 3 x 325 mm (12.8 inch)
IP rating (EN 60529)	IP 54
Specification according to	EN 54-2 A1:2006 EN 54-4 A2:2006 EN 12094-1:2003
Color	RAL 7035
Weight	approx. 51 kg (112.4 lbs)
Mounting	Wall-mounted installation

Part no.: 910890

Medium-size base unit of the fire alarm panel range FMZ 5000. 19" wall enclosure with front door in stainless steel colored frame. Equipped and ready for fire detection, monitoring and control for one single-zone extinguishing system in a maximum of 256 devices in analogue addressable technology and a maximum of 256 devices in conventional technology. Signal indication through large LC display and LEDs, menu-guided operation using function keys.

Product features

- Expansion of the fire alarm panel is designed for controlling of one single-zone extinguishing system
- 2 detector loops, 8 conventional detector lines, 4 control groups, 8 relays with 1 potential-free changeover contact each
- Collective signal LED and 16 individual LED pairs, red/yellow, for status indications
- Large LC display, full graphical with menu-guided operation
- Emergency power batteries 26 Ah
- The fire alarm panel is preconfigured and just needs individual settings

Included in delivery

Fire alarm panel with front display and operating plate,
 1 Central card
 1 Power supply unit 5 A
 1 Loop module
 2 Conventional detector module
 1 Control group module
 1 Relay module
 1 Power distribution module
 1 Zone operating panel card
 2 26 Ah batteries

Wired ready for operation and preconfigured.
Operating instructions, terminal assignment, operator's log,
installation manual, drilling stencil.

Approvals / marking



G 204124
G 205019



0786-CPD-20843
0786-CPD-20222





Fire detection and suppression control panels

FMZ 5000

Fire alarm panel FMZ 5000 mod XL 21U

Part no.: 905454

Base unit from the fire alarm panel range FMZ 5000 as 19" version in a wall enclosure with a height of 21U. For connecting analogue addressable detectors and conventional detectors in standard or industrial design. Activation of remote transmission units for fire and fault signals, data transfer to management systems and control stations with open interfaces. Signal indication through large LC display and LEDs, menu-guided operation using function keys.

Application

For use for sole fire detection control or combined fire detection and extinguishing control in medium scale projects. Also control of multi-zone extinguishing systems through redundant hardware.

Technical specifications

Mains voltage	115 V / 230 V AC -15%, +10%
Mains frequency	50 Hz - 60 Hz
Operating voltage	nom. 24 V DC min. 21 V DC max. 27.2 - 29 V DC
Power supply unit	see table at the end of the chapter
Quiescent current	approx. 120 mA DC
Battery	see table at the end of the chapter
External control voltage	min. 21 V DC max. 27.2 - 29 V DC
Ambient temperature	-5°C to +40°C (+23 °F to +104 °F)
Relative humidity (IEC 721-3-3)	max. 95 % no condensation
Enclosure	Sheet steel 21U
Dimensions	600 x 1012 x 373 mm (WxHxD) 23.6 x 39.8 x 14.7 inch (WxHxD) Length of mounting rail 4 x 325 mm (12.8 inch) usable mounting rail length for function modules 2 x 270 mm (10.6 inch), 1 x 170 mm (6.7 inch)
IP rating (EN 60529)	IP 55
Color	RAL 7035
Weight	approx. 70 kg (154.3 lbs) without modules
Mounting	Wall-mounted installation

Product features

- Free selection of functional modules to be used for all project tasks
- Can also be expanded for controlling multi-zone extinguishing systems with redundant modules
- Up to 28 detector loops with 126 detectors each, up to 176 conventional detector lines for 32 detectors of any design each
- Up to 176 control groups and 176 relays
- 14 collective signal LEDs, some in two colors, max. 272 LED pairs, red/yellow, for signal indications
- Large LC display, full graphical with menu-guided operation
- Can be loop networked up to 32 units
- All settings are defined via a fully graphical interface on a PC with the MxSysCon configuration program

Included in delivery

Fire alarm panel in 21U wall enclosure fitted with front display and operating plate, central card. Wired ready for the insertion of any modules. No additional wiring within the fire alarm panel required for expansion. Operating instructions, operator's log, mounting manual.

Not included in delivery

Cable set FMZ 5000 mod XL module 905113
Modules, zone operating panel card, power supply unit, front plate BBF, dummy plates, batteries, report printer, installation material.

Note

Control panel without power supply unit. The power supply unit and the batteries must be selected according to the table at the end of the chapter.

Approvals / marking

(depending on power supply unit)



G 204124
G 205019



0786-CPD-20843
0786-CPD-20222





Fire detection and suppression control panels

FMZ 5000

Fire alarm panel FMZ 5000 mod XL 40U



Application

For use for sole fire detection control or combined fire detection and extinguishing control in projects up to very large size. Also control of multi-zone extinguishing systems through redundant hardware.

Technical specifications

Mains voltage	115 V / 230 V AC -15%, +10%
Mains frequency	50 Hz - 60 Hz
Operating voltage	nom. 24 V DC min. 21 V DC max. 27.2 - 29 V DC
Power supply unit	see table at the end of the chapter
Quiescent current	approx. 120 mA DC
Battery	see table at the end of the chapter
External control voltage	min. 21 V DC max. 27.2 - 29 V DC
Ambient temperature	-5°C to +40°C (+23 °F to +104 °F)
Relative humidity (IEC 721-3-3)	max. 95 % no condensation
Enclosure	Sheet steel 40U
Dimensions	800 x 2000 x 600 mm (WxHxD) (31.5 x 78.7 x 23.6 inch) (WxHxD) (H without base) Length of mounting rail 7 x 475 mm (18.7 inch) usable mounting rail length for function modules 5 x 425 mm (16.7 inch), 1 x 325 mm (12.8 inch)
IP rating (EN 60529)	IP 53 with separate cable gland IP 55
Color	RAL 7035
Weight	approx. 190 kg (418.9) without modules
Mounting	Stand-alone cabinet

Part no.: 905041

Base unit from the fire alarm panel range FMZ 5000 as 19" version in a free-standing cabinet with a height of 40U with variable depth, width and base dimensions and various design variants.

For connecting analogue addressable detectors and conventional detectors in standard or industrial design. Activation of remote transmission units for fire and fault signals, data transfer to management systems and control stations with open interfaces.

Signal indication through large LC display and LEDs, menu-guided operation using function keys.

Product features

- Free selection of functional modules to be used for all project tasks
- Can also be expanded for controlling multi-zone extinguishing systems with redundant modules
- Up to 28 detector loops with 126 detectors each, up to 256 conventional detector lines for 32 detectors of any design each
- Up to 256 control groups and 256 relays
- 14 collective signal LEDs, some in two colors, max. 432 LED pairs, red/yellow, for signal indications
- Large LC display, full graphical with menu-guided operation
- Can be loop networked with up to 32 units
- All settings are defined via a full graphical interface on a PC with the MxSysCon configuration program

Included in delivery

Fire alarm panel in free-standing enclosure fitted with front display and operating plate, control card. Wired ready for insertion of any modules. No additional wiring within the fire alarm panel required for expansion. Operating instructions, operator's log, mounting manual.

Not included in delivery

Cable gland 800 mm IP rating IP 55	908504
Cable set FMZ 5000 mod XL module	905113

Modules, zone operating panels, dummy front plates, power supply unit, batteries, report printer, installation material.

Note

Control panel without power supply unit. The power supply unit and the batteries must be selected according to the table at the end of the chapter.

Approvals / marking

(depending on power supply unit)



G 204124
G 205019



0786-CPD-20843
0786-CPD-20222





Fire detection and suppression control panels

FMZ 5000 modules/cards

FMZ 5000 Loop AP XP module



Product features

- For the interface connection of analogue addressable detectors and modules with Loop AP protocol
- The high loop current enables the operation of multiple modules, sounders, flash lights and detectors in a single loop
- All settings of the module, the detectors and the detector zones are configured using the MxSysCon configuration program
- No further adjustment is required

Technical specifications

Operating voltage (module)	18 V - 30 V DC
Quiescent current (module-bus)	max. 52 mA DC
Supply current	max. 1.440 mA DC
Loop current	max. 400 mA DC
Loop voltage	27 V DC
Number of loops	2
Number of detectors per loop	126
Max. terminal cross-section	2.5 mm ² (AWG 13)
Ambient temperature	-5 °C to +40 °C (+23 °F to +104 °F)
Relative humidity (IEC 721-3-3)	max. 95 % no condensation
IP rating (EN 60529)	IP 20
Enclosure	Polyamide PA6.6, green
Installation position	vertical
Mounting	Mounting rail 35 mm DIN 46277, top hat profile
Weight	220 g (0.5 lbs)
Dimensions	35 x 99 x 114.5 mm (WxHxD) 1.4 x 3.9 x 4.5 inch (WxHxD)
Total cable length	max. 2000 m (6562 ft) per loop

Part no.: 906185

Functional module for use in all design variants of the fire detection series FMZ 5000. Includes 2 detector loops for connection of up to 126 devices each. Instead of a loop, 2 branches can be connected to the module. Any number of T branches can be connected to each loop. The loop devices can be fire detectors, input/output modules, control modules for sounders and loop couplers for the operation of conventional detectors in the loop. For use in potentially explosive atmospheres, IS-detectors can be connected to the loop via protocol interface and safety barriers.

Application

For fire detection with detectors using loop technology. System monitoring by connecting switches to addressable input modules. Control of fire protection devices via dry contacts or monitored via output modules. Interface connection of monitored zone horns via a sounder module. For the operation of conventional detectors in the loop, these are connected to a loop coupler. The module is inserted into the panel with separate power supply by power distribution module. The power supply and system communication are connected via plug-in connections on the module enclosure. Up to 14 modules can be used in one fire alarm panel.

Included in delivery

Module completely assembled and ready for installation in the fire alarm panel.

Not included in delivery

4 Socket terminal strips FKCT 2.5/3-ST	901564
Power distribution module	904093

Optional accessories

Programming device FMZ5000 Loop AP	904556
------------------------------------	--------

Application in potentially explosive atmospheres

Only the following barriers are permitted:

Safety barrier IS addressable 24 V	901324
Loop AP protocol interface	901322

Note

If the loops of one loop module are used for fire detection or controlling several extinguishing zones, the loop module AP XP redundant, part no. 906186, must be used.

Approvals / marking

See panels



Fire detection and suppression control panels

FMZ 5000 modules/cards

FMZ 5000 Loop AP XP redundant module

Part no.: 906186

Functional module for use in all design variants of the fire detection series FMZ 5000. The loop module includes two redundant processors for the operation in multi-zone extinguishing systems in accordance with standards. Includes 2 detector loops for connection of up to 126 devices each. Instead of a loop, 2 branches can be connected to the module. Any number of T branches can be connected to each loop. The loop devices can be fire detectors, input/output modules, control modules for sounders and loop couplers for the operation of conventional detectors in the loop. For use in potentially explosive atmospheres, IS-detectors can be connected to the loop via protocol interface and safety barriers.

Product features

- Includes redundant processors for the control of the module and the loops
- For the interface connection of analogue addressable detectors and modules with Loop AP protocol
- The high loop current enable the operation of multiple modules, sounders, flash lights and detectors in a single loop
- All settings of the module, the detectors and detector zones are carried out with the MxSysCon configuration program
- No further adjustment is required

Application

For fire detection in several zones of multi-zone extinguishing systems by means of detectors using loop technology. System monitoring by connecting switches to addressable input modules. Control of fire protection devices via dry contacts or monitored via output modules. Interface connection of monitored zone horns via a sounder module. For the operation of conventional detectors in the loop, these are connected to a loop coupler. The module is inserted into the panel with separate power-supply by power distribution module. The power supply and system communication are connected via plug-in connections on the module enclosure. Up to 14 modules can be used in one fire alarm panel.

Technical specifications

Operating voltage (module)	18 V - 30 V DC
Quiescent current (module-bus)	max. 85 mA DC
Supply current	max. 1440 mA DC
Loop current	max. 400 mA DC
Loop voltage	27 V DC
Number of loops	2
Number of detectors per loop	126
Max. terminal cross-section	2.5 mm ² (AWG 13)
Ambient temperature	-5 °C to +40 °C (+23 °F to +104 °F)
Relative humidity (IEC 721-3-3)	max. 95 % no condensation
IP rating (EN 60529)	IP 20
Enclosure	Polyamide PA6.6, green
Installation position	vertical
Mounting	Mounting rail 35 mm DIN 46277, top hat profile
Weight	220 g (0.5 lbs)
Dimensions	35 x 99 x 114.5 mm (WxHxD) 1.4 x 3.9 x 4.5 inch (WxHxD)
Total cable length	max. 2000 m (6562 ft) per loop

Included in delivery

Module completely assembled and ready for installation in the fire alarm panel.

Not included in delivery

4 Socket terminal strips FKCT 2.5/3-ST	901564
Power distribution module	904093

Optional accessories

Programming device FMZ5000 Loop AP	904556
------------------------------------	--------

Application in potentially explosive atmospheres

Only the following barriers are permitted:

Safety barrier IS addressable 24 V	901324
Loop AP protocol interface	901322

Note

For fire detection in single-zone extinguishing systems, the module loop AP XP, part no. 906185, can be used.

Approvals / marking

See panels



Fire detection and suppression control panels

Modules/cards

Module Conventional detector



Product features

- Large range of detector types available for in virtue of the wide adjustment range of the line voltages and current thresholds
- All detectors can be operated with two-detector dependency and all zones with two-zone dependency
- All settings are carried out with the MxSysCon configuration program
- No further adjustment is required

Technical specifications

Operating voltage	19 V - 29 V DC
Quiescent current	2 mA - 50 mA DC
Line voltage	9 V - 20 V DC
Alarm current	5 mA - 80 mA DC
Terminating resistor	1.8 kΩ
Number of detector groups	4, quiescent current controlled
Number of detectors per line	32 pieces (VdS)
Max. terminal cross-section	2.5 mm ² (AWG 13)
Ambient temperature	-5 °C to +40 °C (+23 °F to +104 °F)
Relative humidity	max. 95 % no condensation
IP rating (EN 60529)	IP 20
Enclosure	Polyamide PA6.6, green
Installation position	vertical
Mounting	Mounting rail 35 mm DIN 46277, top hat profile
Weight	120 g (0.26 lbs)
Dimensions	17.5 x 99 x 114.5 mm (WxHxD) 0.7 x 3.9 x 4.5 inch (WxHxD)

Part no.: 901773

Functional module for use in all design variants of the fire detection series FMZ 5000. Includes 4 quiescent current monitored detector lines for the connection of conventional detectors in accordance with the applicable national regulations. A detector event is reported via a current increase. Each line has 4 adjustable thresholds: quiescent current, wire breakage, short circuit, event. The voltage of each line can be adjusted separately in the range of 9 V to 20 V.

All conventional detectors in the Minimax detector range can be used with this operating voltage range, as well as devices from other manufactures.

Application

For connection of any type of conventional detectors or manual call points in standard or industrial design. System monitoring takes place by connecting appropriate monitoring switches with dry contacts. The module is inserted into the panel without additional wiring. The power supply and system communication are connected via plug-in connections on the module enclosure. Up to 64 modules can be used in one fire alarm panel.

Included in delivery

Module completely assembled and ready for installation in the panel.

Not included in delivery

4 Socket terminal strips FKCT 2.5/3-ST 901564

Note

Each module may be operated only with detectors produced by one manufacturer.

Approvals / marking

See panels



Fire detection and suppression control panels

Modules/cards

Module Control groups



Product features

- Control groups can be time-controlled with delays, pulse controlled or continuously controlled
- All settings are carried out with the MxSysCon configuration program.
- No further adjustment work is required

Technical specifications

Operating voltage	21 V - 29 V DC
Quiescent current	25 mA DC
Number of control groups	4, quiescent current monitored
External control groups	21 V - 29 V DC
Output current	1 A, continuous load
Control	time-controlled, continuous, pulse, inverted
Max. terminal cross-section	2.5 mm ² (AWG 13)
Ambient temperature	-5 °C to +40 °C (+23 °F to +104 °F)
Relative humidity (IEC 721-3-3)	max. 95 % no condensation
IP rating (EN 60529)	IP 20
Enclosure	Polyamide PA6.6, green
Installation position	vertical
Mounting	Mounting rail 35 mm DIN 46277, top hat profile
Weight	100 g (0.2 lbs)
Dimensions	17.5 x 99 x 114.5 mm (WxHxD) 0.7 x 3.9 x 4.5 inch (WxHxD)

Part no.: 901673

Functional module for use in all design variants of the fire detection series FMZ 5000.

Includes 4 control lines for the monitoring and control of fire protection devices. The line to the devices is monitored for wire breakage and short circuits.

The connected fire protection devices are also monitored to verify that they are present and in proper condition.

Application

For monitoring and control of e.g. valves, solenoids or horns in extinguishing systems or other fire protection devices.

The module is inserted into the panel with separate power supply by power distribution module. The power supply and system communication are connected via plug-in connections on the module enclosure.

Up to 64 modules can be used in one fire alarm panel.

Included in delivery

Module completely assembled and ready for installation in the fire alarm panel.

Not included in delivery

4 Socket terminal strips FKCT 2.5/3-ST 901564

Spare parts

Fuse 2 A / 125 V 784352

Note

If the module is used to sounders or extinguishing devices in multi-zone extinguishing systems, a separate control group module must be used for each extinguishing zone.

Approvals / marking

See panels



Fire detection and suppression control panels

Modules/cards

FMZ 5000 8 Relay module



Part no.: 901595

Functional module for use in all design variants of the fire detection series FMZ 5000.

The module has 8 relays, each with a dry contact.

An activated relay is indicated by a red status LED.

A separate relay card with up to 8 additional relays can be

connected via a plug connector strip. Control happens via

open collector outputs parallel to the relays in the module.

This allows relays with higher switching voltages or currents to be used.

Product features

- Relays are time-controlled with delays, pulse control or continuous control
- All settings are carried out with the MxSysCon configuration program
- No further adjustment work is required

Application

For the dry-contact control of e.g. fire protection devices, graphic annunciators, ventilation system shutdown or for general signal transfer.

The module is inserted into the panel without additional wiring. The power supply and system communication are connected via plug-in connections on the module enclosure. Up to 64 modules can be used in one fire alarm panel.

Technical specifications

Operating voltage	19 V - 29 V DC
Quiescent current	10 mA DC
Current per relay	10 mA DC
Number of relays	8 TQ
Contacts per relay	1 changeover, dry
Contact load	1 A / 30 V DC, 0.5 A / 125 V AC
Max. switching capacity	30 W / 62.5 VA
Control	Time-controlled, continuous, pulse, inverted
Max. terminal cross-section	2.5 mm ² (AWG 13)
Ambient temperature	-5 °C to +40 °C (+23 °F to +104 °F)
Relative humidity (IEC 721-3-3)	max. 95 % no condensation
IP rating (EN 60529)	IP 20
Enclosure	Polyamide PA6.6, green
Installation position	vertical
Mounting	Mounting rail 35 mm DIN 46277, top hat profile
Weight	170 g (0.4 lbs)
Dimensions	35 x 99 x 114.5 mm (WxHxD) 1.4 x 3.9 x 4.5 inch (WxHxD)

Included in delivery

Module completely assembled and ready for installation in the fire alarm panel.

Not included in delivery

8 socket terminal strips FKCT 2.5/3-ST	901564
Relay card 8 TQ	800843
Relay card 8	802587

Note

The contacts of the relays in the module are not suitable for the switching of 230/110 V AC mains voltage.

Approvals / marking

See panels



Fire detection and suppression control panels

Modules/cards

Impulse valve reset module



Product features

- Valve can also be closed via an external button
- The open status of the valves can be displayed on a connectable status display or forwarded via a relay
- Space-saving setup due to narrow module enclosure on a mounting rail

Technical specifications

Operating voltage	19 V - 27 V DC
Quiescent current	20 mA DC
Permissible current open valve	≤ 1 A DC
Permissible current close valve	≤ 1 A DC
External display voltage	24 V DC
Permissible current external display	≤ 1 A DC
Max. terminal cross-section	2.5 mm ² (AWG 13)
Ambient temperature	-5 °C to +40 °C (+23 °F to +104 °F)
Ambient temperature storage	-10 °C to +70 °C (+14 °F to +158 °F)
Relative humidity (IEC b721-3-3)	max. 95 % no condensation
IP rating (EN 60529)	IP 20
Enclosure	Polyamide PA6.6, green
Installation position	vertical
Mounting	Mounting rail 35 mm DIN 46277, top hat profile
Weight	150 g (0.3 lbs)
Dimensions	17.5 x 93 x 108 mm (WxHxD) 0.7 x 3.9 x 4.5 inch (WxHxD)

Part no.: 908324

Functional module for use in all design variants of the fire detection series FMZ 5000.

The module contains all connections and functions for controlling and resetting an impulse valve in water extinguishing systems with 24 V DC operating voltage. The operating positions of the valve are represented by two LEDs. The order to reset the valve is given via an external button connected to the module or a relay contact. Can be installed in the extinguishing control panel or in a separate housing with a mounting rail.

Application

The module is used for controlling impulse valves in water extinguishing systems. The impulse valve contains two coils, one for opening and one for closing the valve. The valve will remain in the last position if the power supply is switched off. For opening or closing progress the respective coils can be controlled in impulse mode.

Included in delivery

Module completely assembled and ready for installation in the fire alarm panels with socket terminals.

Not included in delivery

Control group module, remote control buttons, external displays, forwarding relay.

Optional accessories

Module FMZ5000 control groups 901673

Connection / mounting

DIN hat rail as per IEC/EN 60715. Module can also be used in separate enclosure outside the extinguishing control panel.

Note

The module does not monitor the supply to the open coil. Control group module (part no. 901673) can be used to monitor the impulse valve open coil.

Approvals / marking

See panels



Fire detection and suppression control panels

Modules/cards

FMZ 5000 ground fault module



Part no.: 800096

Function module for monitoring and signaling a ground fault. The module monitors in a connected device the galvanic separation between protective earth (PE) and all secondary DC voltages inclusive of the ground wire as reference potential.

Product features

- Ground fault monitoring of lines carrying direct current
- Function test by means of test button
- Transmission through dry contact and open collector output
- Easy installation in alarm systems, as the event and terminating resistor are integrated for connection of a conventional detector group

Application

The ground fault module is fitted in the device to be monitored or in its vicinity on a mounting rail. If the resistance between the DC voltage potentials in the device and the protective earth should drop below a certain value, then an open collector output is triggered for retransmission. For fire detection control panels, e.g. the cables of detector groups, triggering of horns and supply voltages can be monitored.

Technical specifications

Operating voltage	18 V - 30 V DC
Quiescent current	approx. 7 mA DC
Current in case of earth fault	approx. 15 mA DC
Test voltage (IEC 950)	500 V AC, 700 V DC
Resistance 0 V - PE	approx. 620 kOhm
Response threshold	approx. 50 kOhm
Terminal capacitance	max. 20 µF
Max. terminal cross-section	2.5 mm ² (AWG 13)
Ambient temperature	-5 °C to +40 °C (+23 °F to +104 °F)
Storage temperature	-10 °C to +50 °C (+14 °F to +122 °F)
Relative humidity (IEC 721-3-3)	max. 95 % no condensation
IP rating (EN 60529)	IP 20
Enclosure	Polyamide PA6.6, green
Installation position	vertical
Mounting	Mounting rail 35 mm DIN 46277, top hat profile
Weight	67 g (0.15 lbs)
Dimensions	19 x 81 x 70 mm (WxHxD) 1.4 x 3.9 x 4.5 inch (WxHxD)

Included in delivery

Module completely assembled and ready for the installation in the fire alarm panels, inclusive connection and commissioning instructions.

Not included in delivery

Test button

Note

As the GND lines of detector groups in explosive areas with the ignition protection type intrinsically safe Ex i are connected with PE via an upstream Zener barrier, use of the module is not possible.

Approvals / marking

See panels



Fire detection and suppression control panels

Modules/cards

Power distribution module



Product features

- 5 terminals each to take 24V and GND for the supply of connected devices (1 pair of terminals for supply)
- Protects connected devices from transient overvoltage
- No settings on the module are required

Technical specifications

Operating voltage	19 V - 29 V DC
Output current	4 A DC
Max. terminal cross-section	2.5 mm ² (AWG 13)
Ambient temperature	-5 °C to +40 °C (+23 °F to +104 °F)
Relative humidity (IEC 721-3-3)	max. 95 % no condensation
IP rating (EN 60529)	IP 20
Enclosure	Polyamide PA6.6, green
Installation position	vertical
Mounting	Mounting rail 35 mm DIN 46277, top hat profile
Weight	85 g (0.2 lbs)
Dimensions	22.5 x 99 x 114.5 mm (WxHxD) 0.9 x 3.9 x 4.5 inch (WxHxD)

Part no.: 904093

Module for use in all design variants of the fire detection series FMZ 5000. It includes protection elements for diverting overvoltage to the protective earth.

Application

The power distribution module is used for the star-configuration power supply of modules with high output currents e.g. the control group module and Loop module AP XP. It also diverts transient overvoltage from the modules to the protective earth. Normally a power distributor is fitted at the end of a module row. One module can be set per module row (via mounting rail).

Included in delivery

Module completely assembled and ready for installation in the fire alarm panel.

Not included in delivery

4 socket terminal strips FKCT 2.5/3-ST 901564

Note

If the power distribution module is used to supply external devices directly, each outgoing 24 V supply must be fuse-protected. The module is not a substitute for surge arrestors necessary for lightning protection.

Approvals / marking

See panels



Fire detection and suppression control panels

Modules/cards

Reflex module

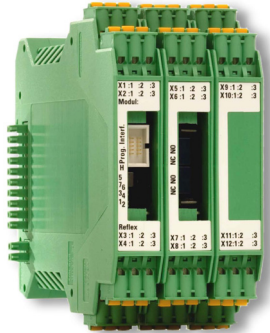

Product features

- Instant fire detection and extinguishing for two mutually independent extinguishing zones
- Display of fire alarm messages and extinguishing events accurate to the millisecond
- Spark counter for maximum number or average of detected sparks per unit of time, in order to e.g. carry out machine shutdowns

Technical specifications

Operating voltage	19 V - 27 V DC
Quiescent current	30 mA DC
Number of detector lines	2
Number of control groups	2
Number of monitoring lines	4
No. of detectors per line	8 spark detectors 4 flame detectors
Maximum current per control group	2.6 A DC
Functions monitored	No extinguishing, extinguishing time too long, leakage, blockage, detector fault
Line monitoring	All lines for wire breakage, short circuits
Ambient temperature	-5 °C to +40 °C (+23 °F to +104 °F)
Relative humidity	max. 95 % no condensation
IP rating (EN 60529)	IP 20
Enclosure	Polyamide PA6.6, green
Installation position	vertical
Mounting	Mounting rail 35 mm DIN 46277, top hat profile
Weight	290 g (0.6 lbs)
Dimensions	53 x 99 x 114.5 mm (WxHxD) 2.1 x 3.9 x 4.5 inch (WxHxD)
Performance Level acc. to ISO 13849	c*

* The calculation results are restricted to the hardware

Part no.: 906262

Functional module for use in all design variants of the fire detection series FMZ 5000.

The reflex module contains all components for flame or spark detection, extinguishing and monitoring for 2 extinguishing zones where very fast fire detection and virtually instantaneous extinguishing are of particular importance. Conventional spark or flame detectors can be connected to conventional detector technology. All connected detectors and extinguishing components and their wiring are monitored for wire breakage and short circuits. In addition, fault signals from self-monitoring detectors are processed and displayed.

Application

The reflex module is used for fire protection in pneumatic conveying systems, painting facilities, machine tools or wherever there is a risk of rapidly spreading fires. Instantaneous ejection of combustible material is likewise possible.

In painting facilities, flames caused by high voltage flashovers are extinguished immediately by cutting off the supply of paint and applying extinguishing agents through the paint spray nozzles.

In machine tools, the machining process is monitored and in the event of the machined material or cooling agent catching fire, the tool is stopped immediately and extinguishing can be initiated instantly.

Included in delivery

Module completely assembled and ready for installation in the fire alarm panel.

Not included in delivery

12 socket terminal strips FKCT 2.5/3-ST 901564

Note

Up to 40 modules can be used in one fire alarm panel.

Approvals / marking

See panels



Fire detection and suppression control panels

Modules/cards

MxNet module

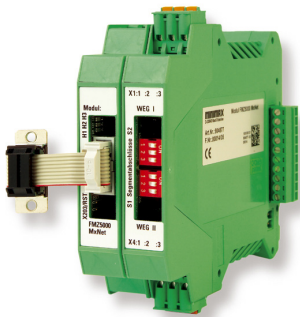

Product features

- Communication to the networked devices uses the MX2 protocol in all versions
- Up to 32 devices can be networked in a ring
- No adjustment work is required

Technical specifications

Operating voltage	19 V - 29 V DC
Quiescent current	58 mA DC
Outputs	COM1 RS-232 SUB-D socket Path 1 RS-485 modular terminal Path 2 RS-485 modular terminal
Max. terminal cross-section	2.5 mm ² (AWG 13)
Ambient temperature	-5 °C to +40 °C (+23 °F to +104 °F)
Relative humidity (IEC 721-3-3)	max. 95 % no condensation
IP rating (EN 60529)	IP 20
Enclosure	Polyamide PA6.6, green
Installation position	vertical
Mounting	Mounting rail 35 mm DIN 46277, top hat profile
Weight	200 g (0.4 lbs)
Dimensions	35 x 99 x 114.5 mm (WxHxD) 1.4 x 3.9 x 4.5 inch (WxHxD)

Part no.: 904877

Functional module for use in all design variants of the fire detection series FMZ 5000, as well as mimic panels and operating panels.

Allows devices to be connected in a line-redundant loop network. Communication with the connected devices takes place via a serial interface in RS-232 standard.

All data lines are continuously monitored. In the event of line faults in the network, line redundancy means that the functions of the devices are not affected.

The module is supplied with power by the networked device.

Application

The module enables a device to communicate with other devices in a loop network. The signals from the devices can be displayed at several central control points. Likewise, commands to the devices are possible from different points in the network and from outside the network (control stations). For each network participant a module required.

Included in delivery

Module completely assembled and ready for installation in the fire alarm panel

Note

All parameters can be set using jumpers.

Module is preconfigured by jumpers.

Alternatively the module and the network can be configured centrally using the configuration program "MxNet.exe".

Use of the module in a FMZ 5000 fire detection control panel requires additionally a

module SIO1 903466

or

module SIO3 903467

The module must be placed directly to the right of the SIO module. Activation is done via the RS-232 interface by means of a ribbon cable.

The network can be executed in fiber optics, for this the module FO-RS485 converters MxNet, part no. 922034, is required.

Approvals / marking

See panels



Fire detection and suppression control panels

Modules/cards

Module LWL-RS485 converter MxNet



Product features

- Communication of the MX2-Protocol via fiber optic
- Transfer of the MX2-Protocol on distances up to 4.200 m
- No adjustment work necessary

Technical specifications

Rated voltage DC	18 to 30 V
Current consumption max.	130 mA
Output	RS-485 interface, 2-wire
Operating mode	half-duplex
Max. terminal cross-section	2.5 mm ² (AWG 13)
Min. transmit capacity	- 4 dBm (200/230 μm) - 17.6 dBm (50/125 μm) - 14 dBm (62.5/125 μm)
Min. receiver sensitivity	- 32.5 dBm (50/125 μm) - 32.5 dBm (62.5/125 μm) - 32.1 dBm (200/230 μm)
Overload limit receiver	- 3 dBm (200/230 μm)
Wavelength	850 nm
Transmission length incl. 3 dB system reserve	2800 m (with F-K 200/230 8 dB/km with quick mounting connector) 4200 m (with F-G 50/125 2.5 dB/km) 3300 m (with F-G 62.5/125 3.0 dB/km)
Transmission medium	PCF-fiber, multi-mode fiberglass
Transmission protocol	protocol-transparent to the RS-485 interface
Connection method	B-FOC (ST®)
Ambient temperature	-20 °C to +60 °C (-4 °F to +140 °F)
Relative humidity (IEC 721-3-3)	30 % to 95 % no condensation
IP rating (EN 60529)	IP 20
Material	Polyamide PA6.6, green
Installation position	vertical
Mounting	Mounting rail 35 mm DIN 46277, top hat profile
Weight	approx. 260 g (0.6 lbs)
Dimensions	35 x 99 x 105 mm (WxHxD) (1.4 x 3.9 x 4.1 inch (WxHxD))

Part no.: 922034

Functional module for operation in all design variants of the fire detection and suppression control panel series. Allows the networking of participants in a ring-shaped line-redundant network over longer distances. Communication with the MxNet module, part no. 904877, is via a serial interface with RS-485 Standard. All data lines are constantly monitored via the Mx-Net. The data connection is via a fiber optic and is resistant to electromagnetic influences. In the event of line disruptions on the network, the functions of the participants are not affected thanks to the line redundancy. The module must be supplied separately with voltage from the control panel system.

Application

The module allows a participant to communicate with other participants in a ring-shaped network over longer distances. Each MxNet module requires one LWL-RS485 converter module for data transmission via the two-core fiber optic. Each LWL-RS485 module converts the data protocol received into light signals and transmits the latter via the two-core fiber optic to the opposite LWL-RS485 module, which converts the signals received into the data protocol in the RS-485 standard again.

Included in delivery

Module completely assembled and ready for installation in the fire alarm panel.

Not included in delivery

Use of the module in a FMZ 5000 fire detection control panel requires additionally a:

- module SIO1 903466
- or
- module SIO3 903467
- and one module MxNet 904877

Approvals / marking

See panels

Ex conformity in acc. with 2014/34/EU II 3 G Ex nA nC IIC T4 Gc X
(The special installation notes must be observed!)

II (2) GD [Ex op is Gb] IIC (PTB 06 ATEX 2042 U)
(The special installation notes must be observed!)

II (2) D [Ex op is Db] IIIC (CPTB 06 ATEX 2042 U)
(The special installation notes must be observed!)

UL, USA / Canada

Class I, Zone 2, AEx nc IIC T5
Class I, Zone 2, Ex nC nL IIC T5 X
Class I, Div 2, Groups A, B, C, D



Fire detection and suppression control panels

Modules/cards

WEBmodule N cpl.



Product features

- Remote polling messages and statuses of fire detection control panels
- Display of the messages and statuses in a web browser
- Messages can be stored to a remote FTP server
- For better evaluation, messages can be repeatedly filtered
- Option of time synchronization by NTP Timeserver

Technical specifications

Operating voltage	19 V - 28 V DC
Quiescent current	80 mA at 24 V DC
Rated current	115 mA at 24 V DC
Data interfaces	1 RS-232 1 Ethernet
Storage temperature	-40 °C to +85 °C (-40 °F to +185 °F)
Ambient temperature	-0 °C to +65 °C (+32 °F to +149 °F)
Relative humidity (IEC 721-3-3)	max. 90 % no condensation
IP rating (EN 60529)	IP 20
Enclosure	Polyamide PA6.6, green
Installation position	vertical
Mounting	Mounting rail 35 mm DIN 46277, top hat profile
Weight	162 g (0.35 lbs)
Dimensions	52 x 99 x 114 mm (WxLxH) 2.1 x 3.9 x 4.5 inch (WxLxH)

Part no.: 914365

Functional module for use in mod 12 and mod XL variants of the FMZ 5000 fire detection series.

The module is intended for the communication with a fire alarm panel via the TCP/IP protocol.

It contains an interface according to the RS-232 standard for communication with the control panel over module SIO1 (part no. 903466) or SIO3 (part no. 903467) via the Mx2 protocol. The connection of the IP network occurs via patch panel to the Ethernet interface with a RJ-45 female connector.

Application

The messages transmitted per Web browser by a fire alarm panel to a PC can be displayed and stored via WEBmodule from any location.

Time synchronization procedures between fire alarm panel and WEBmodule are possible.

These remote diagnostics optimal scheduling of service interventions and increased availability of the fire detection system.

Included in delivery

Module ready for installation into the control panel.

SIO-Adapter FMZ WEBmodule (Connection SIO-Module WEBmodule)	909409
Patch panel	914347
Cable patch cable CAT6 1.0 m (39 inch)	914349

Note

Use a CAT5 or higher category cable for field network connection on the patch panel.

In order to preserve electromagnetic compatibility the direct interconnection between WEBmodule and field network installations is not permitted.

Only use the equipment supplied (patch cable, patch panel) to connect the WEBmodule to the field network installation.

Max. cable length for the RS-232 interface 10 m (390 in).

Any unauthorized access to the control panel has to be prevented by suitable IT protection measures to be taken by the customer.

FMZ 5000 WEBmodule S cpl.

Part no.: 914366

The version WEBmodule S can send switching commands to the connected control panel (deactivates and activates detectors and groups, revision mode, user reset).

Otherwise like part no.: 914365



Fire detection and suppression control panels

Modules/cards

Remote transmission unit module

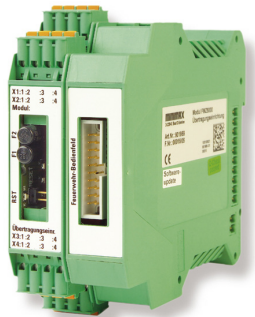

Part no.: 901969

Functional module for use in all design variants of the fire detection series system FMZ 5000. Includes monitoring and control

for 2 remote transmission units (RTU). Each RTU can be used to transmit either fire or fault signals.

In addition

- a fire brigade control panel (FBF) in acc. with DIN 14661
- a fire brigade key depot (FSD) in accordance with German standard VdS 2105 can be connected using adapter.

Product features

- For interface connection with two remote transmission units for fire or fault signals
- Control can be pulsed or continuous
- All settings of the module and the remote transmission units are carried out with the MxSysCon configuration program
- No adjustment work is required

Application

For monitoring and controlling 2 remote transmission units for fire or fault signals to the fire brigade or service points. If a fire brigade control panel is connected, the module controls all the displays on the display panel and polls the operator controls.

With a fire brigade key depot connected, the door opener is activated after a fire brigade call has been issued and the position of the door and the presence of the deposited key is monitored. A maximum of one module can be used in one fire alarm panel.

Technical specifications

Operating voltage	19 V - 29 V DC
Quiescent current	25 mA DC
Outputs	2 RTUs, fire / fault 1 fire brigade control panel 1 fire brigade key depot
Output voltage	24 V DC
Output current	1 A DC per remote transmission unit
Control	continuous, pulsed
Max. terminal cross-section	2.5 mm ² (AWG 13)
Ambient temperature	-5 °C to +40 °C (+23 °F to +104 °F)
Relative humidity (IEC 721-3-3)	max. 95 % no condensation
IP rating (EN 60529)	IP 20
Enclosure	Polyamide PA6.6, green
Installation position	vertical
Mounting	Mounting rail 35 mm DIN 46277, top hat profile
Weight	200 g (0.4 lbs)
Dimensions	45 x 99 x 114.5 mm (WxHxD) 1.8 x 3.9 x 4.5 inch (WxHxD)

Included in delivery

Module completely assembled and ready for installation in the fire alarm panel.

Not included in delivery

2 Socket terminal strips FKCT 2.5/4-ST 901565

Note

When activating a key depot a suitable adapter must be used as well.

Approvals / marking

See panels



Fire detection and suppression control panels

Modules/cards

SIO1 module



Product features

- An RS-232-standard serial interface is connected to an SUB-D socket
- Baud rates adjustable from 300 to 115.200 baud.
- All settings of the module, the application and the communication parameters are carried out with the MxSysCon configuration program.

Technical specifications

Operating voltage	19 V - 29 V DC
Quiescent current	42 mA DC
Outputs	COM1 RS-232 SUB-D socket
Max. terminal cross-section	2.5 mm ² (AWG 13)
Ambient temperature	-5 °C to +40 °C (+23 °F to +104 °F)
Relative humidity (IEC 721-3-3)	max. 95 % no condensation
IP rating (EN 60529)	IP 20
Enclosure	Polyamide PA6.6, green
Installation position	vertical
Mounting	Mounting rail 35 mm DIN 46277, top hat profile
Weight	100 g (0.2 lbs)
Dimensions	22.5 x 99 x 114.5 mm (WxHxD) 0.9 x 3.9 x 4.5 inch (WxHxD)

Part no.: 903466

Functional module for use in all design variants of the fire alarm system FMZ 5000.

Includes a serial communication channel in RS-232 standard. Preferred for data transmission to an WEBmodule, a MxNet module or a report printer. The module status is indicated by 3 LEDs.

Application

For serial data transmission in RS-232 standard. When using the data protocol MX2, all signals from the fire alarm panel can be sent to control stations or visualization programs and commands can be received from them. Up to 3 modules can be used in one fire alarm panel.

Included in delivery

Module completely assembled and ready for installation in the fire alarm panel.

Not included in delivery

SUB-D plug, 9-pin

Note

The interface is not opto-isolated. If devices outside the fire alarm panel system are connected, these must be opto-isolated using a separate converter.

Approvals / marking

See panels



Fire detection and suppression control panels

Modules/cards

SIO3 module

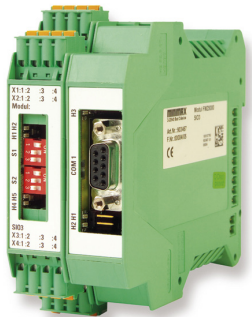

Product features

- The RS-232 serial interface is connected to a 9-pin SUB-D socket
- The RS-422 / 485 serial interfaces (one opto-isolated) are connected to series terminal
- Baud rates are adjustable from 300 to 115.200
- All settings of the module, the communication parameters and the application are carried out with the MxSysCon configuration program

Technical specifications

Operating voltage	19 V - 29 V DC
Quiescent current	58 mA DC
Outputs	COM1 RS-232 SUB-D socket COM2 RS-422 / RS-485 opto-isolated series terminal COM3 RS-422 / RS-485 series terminal
Max. terminal cross-section	2.5 mm ² (AWG 13)
Ambient temperature	-5 °C to +40 °C (+23 °F to +104 °F)
Relative humidity (IEC 721-3-3)	max. 95 % no condensation
IP rating (EN 60529)	IP 20
Enclosure	Polyamide PA6.6, green
Installation position	vertical
Mounting	Mounting rail 35 mm DIN 46277, top hat profile
Weight	190 g (0.4 lbs)
Dimensions	45 x 99 x 114.5 mm (WxHxD) 1.8 x 3.9 x 4.5 inch (WxHxD)

Part no.: 903467

Functional module for use in all design variants of the fire detection series FMZ 5000.

Includes a serial communication channel in RS-232 standard plus two serial communication channels in RS-422 / 485 standard. One RS-422 / 485 channel is opto-isolated for interface connection with devices with an external power supply.

The module status is indicated by 9 LEDs.

Application

For serial data transmission in RS-232, RS-422 or RS-485 standard.

When using the data protocol MX2, all signals from the fire alarm panel can be sent to control stations or visualization programs and commands can be received from them.

Devices with their own power supply can be connected directly to the opto-isolated communication channel.

Up to 2 modules or a total of 6 data channels can be used in one fire alarm panel.

Included in delivery

Module completely assembled and ready for installation in the fire alarm panel.

Not included in delivery

SUB-D plug, 9-pin

4 Socket terminal strips FKCT 2.5/4-ST

901565

Note

Slide switches are used to switch over from RS-422 to RS-485 and to activate the bus terminating resistor.

Only use opto-isolated interfaces for data transmission to external devices or arrange for separate opto-isolation.

The RS-485 interface cannot be used for data transfer with MX 2 protocol.

Approvals / marking

See panels



Fire detection and suppression control panels

Modules/cards

Modbus module

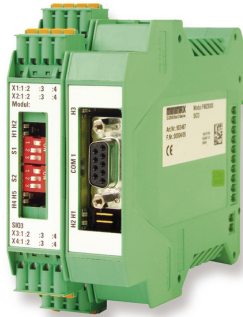

Product features

- All parameters for the transmission of data to a Modbus master are configurable
- Communication to the Modbus master can be point to point
- All settings are carried out with the MxSysCon configuration program
- No adjustment work is required

Technical specifications

Operating voltage	19 V - 29 V DC
Quiescent current	58 mA DC
Outputs	COM1 RS-232 SUB-D socket COM2 RS-422 opto-isolated modular terminal
Max. terminal cross-section	2.5 mm ² (AWG 13)
Ambient temperature	-5 °C to +40 °C (+23 °F to +104 °F)
Relative humidity (IEC 721-3-3)	max. 95 % no condensation
IP rating (EN 60529)	IP 20
Enclosure	Polyamide PA6.6, green
Installation position	vertical
Mounting	Mounting rail 35 mm DIN 46277, top hat profile
Weight	200 g (0.4 lbs)
Dimensions	45 x 99 x 114.5 mm (WxHxD) 1.8 x 3.9 x 4.5 inch (WxHxD)

Part no.: 904566

Functional module for use in all design variants of the fire detection system FMZ 5000.

The module includes an serial interface RS422 standard for communication using the Modbus protocol. It supports the Modbus RTU format. The Modbus module is always the Modbus slave and must be queried by a Modbus master. Each slave can be assigned an address in the range of 1-99.

Application

For the transmission of signals and system states from the FMZ 5000 fire alarm panel to a control station (Modbus master) via the Modbus RTU protocol. Operations such as isolations or resets are also possible from the control station to the panel.

Using separate converter modules connected in series, the transmission can also be carried out using other field bus protocols (e.g. Profibus via adapter).

A maximum of 2 Modbus modules can be used in one fire alarm panel.

Included in delivery

Module completely assembled and ready for installation in the fire alarm panel.

Not included in delivery

4 Socket terminal strips FKCT 2.5/4-ST 901565

Note

The use of the Modbus module is always subject to greatly differing, project-specific requirements. Therefore the required range of functions and all conditions must be defined at an early stage with all project participants and the parties responsible for the modbus master.

If your project requires an RS-458 interface, use the Modbus RS-458 (part no. 906853) module. The RS-232 interface is not suitable for Modbus communication.

Approvals / marking

See panels



Fire detection and suppression control panels

Modules/cards

Modbus RS-485 module



Part no.: 906853

The module uses an RS-485 serial interface for communication by means of a Modbus protocol.

Note

If an RS-422 interface is required in the project, the module Modbus (part no. 904566) must be used. The RS-232 interface is not provided for Modbus communication.

Otherwise like part no. 904566

Product features

Several Modbus modules can be interconnected in bus operation.

Technical specifications

Outputs	COM1 RS-232 SUB-D socket COM2 RS-485 opto-decoupled modular terminal
---------	--



Fire detection and suppression control panels

Modules/cards

24 V to 9 V voltage converter module



Product features

- Fixed voltage regulation to 9.5 V output voltage
- Space-saving assembly via narrow module housing on mounting rail

Technical specifications

Operating voltage	15 V - 28 V DC
Current consumption	0.05 mA - 0.1 mA DC
Output voltage	9.5 V DC
Short circuit disconnection output	125 mA DC
Fuse output	thermally self-resetting
Conductor cross-section	2.5 mm ²
Operating temperature	-20 °C to +70 °C (-4 °F to +158 °F)
Storage temperature	-20 °C to +70 °C (-4 °F to +158 °F)
Relative humidity (IEC 721-3-3)	max. 95 % no condensation
IP rating (EN 60529)	IP 20
Housing	Polyamide PA6.6, green
Mounting position	vertical
Mounting	Mounting rail 35 mm DIN 46277, cap profile
Weight	150 g (0.3 lbs)
Dimensions	23 x 100 x 100 mm (WxHxD) 0.9 x 3.9 x 3.9 inch (WxHxD)

Part no.: 908471

Function module for use of all detectors with 9 V operating voltage on any fire alarm control panels. The module lowers the voltage to a set value and transfers the standby- and alarm current of the connected detectors. When using detectors for hazardous areas with a risk of explosion the requirements of detectors protected against explosion must be observed. When using detectors with the „Intrinsic Safety“ protection type the prescribed safety barriers are to be used.

Application

Detectors suitable for connection:

See detectors with corresponding voltage range and for monitoring of exhaust- and air conditioning ducts. BMX1001 Bypassbox

719754

Applicable safety barrier with suitable detectors:

Safety barrier SBEx-9

933093

Included in delivery

Module completely assembled and ready for installation in the fire alarm panels with connecting plugs.

Connection / mounting

On TH 35 mounting rail in accordance with IEC/EN 60715. Module can also be inserted in separate housings outside the fire alarm control panel.

Connection diagram

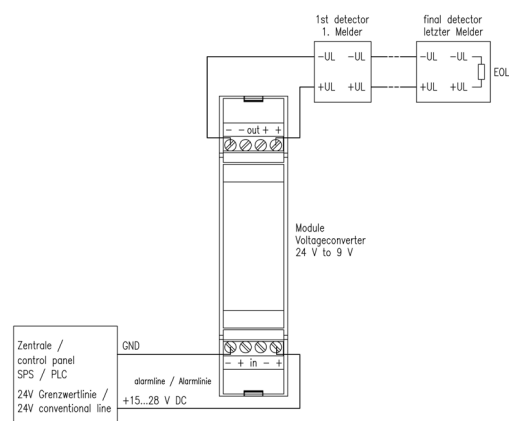

Approvals / marking

See panels



Fire detection and suppression control panels

Modules/cards

Reverse voltage module



Product features

- Polarity switchover for controlling of alarm devices
- 2 switchover circuits, electrically separated from one another
- For a polarity switchover of one or two primary control groups
- Easy installation in alarm systems using mounting rail (DIN rail)

Technical specifications

Operating voltage	19 V - 29 V DC
Quiescent current	0 mA
Max. contact rating	max. 3 A at 30 V DC
Number of switchover circuits	2
Max. terminal cross-section	2.5 mm ² (AWG 13)
Operating temperature	-5 °C to +40 °C (+23 °F to +104 °F)
Storage temperature	-10 °C to +50 °C (+14 °F to +122 °F)
Relative humidity (IEC 721-3-3)	max. 95 % no condensation
IP rating (EN 60529)	IP 20
Enclosure	Polyamide PA6.6, green
Installation position	vertical
Mounting	Mounting rail 35 mm DIN 46277, top hat profile
Weight	70 g (0.15 lbs)
Dimensions	19x81x70 mm (WxHxD) 1.4 x 3.9 x 4.5 inch (WxHxD)

Part no.: 915945

Functional module for connection of alarm devices by using a polarity switchover.

The module FMZ 5000 reverse voltage realizes a polarity switchover of one or two primary control groups within the fire detection and extinguishing control panel. When in idle state, the alarm devices are connected with „reversed“ polarity. The polarity is changed back in activated condition and the alarm devices activate.

Included in delivery

- 1 Module (ready-to-install) with all connecting terminals
- 2 End-of-line resistors (EOL) 1k / 3/4W
- 1 Product information

Note

All alarm devices in the product portfolio can be operated with reverse voltage.

Connection diagram

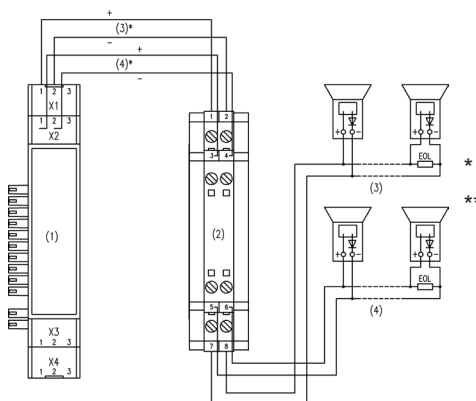

* All Mx alarm devices have a diode included

** End-of-line resistor (EOL) included in delivery (2 pieces)

Optionally, the control group 3 and/or 4 or also control groups of different control group modules can be used. Both switchover circuits of the module FMZ 5000 reverse voltage are electrically separated from one another.

Approvals / marking

See panels



Fire detection and suppression control panels

Modules/cards

Card interface module V11

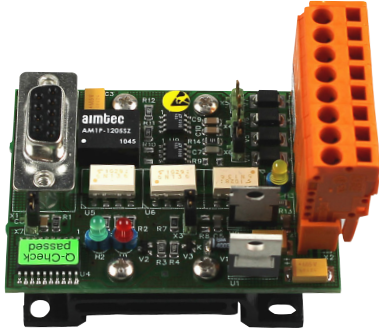

Part no.: 852278

Functional module for use in all design variants of the fire detection series FMZ 5000. Includes opto-isolated, serial communication channels in RS-232 and RS-422 / RS-485 standard. Preferred for data transmission to an SIO1 or SIO3 module, WEBmodule, MxNet module or a report printer. The module status is indicated by 3 LEDs.

Product features

- 10 m (33 ft) maximum cable length between SIO1 or SIO3 module (COM 1) and interface module V11
- 1200 m (3937 ft) maximum cable length between SIO3 COM 1 or COM 3 and interface module V1
- 1200 m (3937 ft) maximum cable length between two V11 interface modules

Application

The interface module V11 can be used for interface conversion from RS-232 to RS-422 / RS-485 and reverse. It serves to extend the length from 10 m (394 inch (RS-232)) to a maximum of 1.200 m (3.937 ft (RS-422 / RS-485)). The interface module V11 has to be mounted in the enclosure of the FMZ 5000 panel.

Technical specifications

Operating voltage	12 V - 24 V DC
Quiescent current	approx. 25 mA
Output	COM1 RS-232 SUB-D socket COM2 RS-422 series terminal
Conductor cross-section	2.5 mm ² (AWG 13)
Operating temperature	-5 °C to +40 °C (+23 °F to +104 °F)
Relative humidity (IEC 721-3-3)	max. 95 % no condensation
Mounting	Mounting rail 35 mm DIN 46277, top hat profile
Weight	55 g (0.12 lbs)
Dimensions	51 x 68 mm (WxH) 2.0 x 2.7 inch (WxH)

Included in delivery

Card interface module V11

Not included in delivery

Cable connection 800497



Fire detection and suppression control panels

Accessories

Safety barrier Ex Loop AP 24 V



Product features

- Device ready for connection for mounting on a mounting rail TS35 (DIN rail)
- No adjustment or maintenance work required
- Galvanic isolation of the input from the safety area
- Intrinsically safe electric circuit suitable for Ex zones 0, 1, 2, 20, 21 and 22

Technical specifications

Rated voltage	$U_N = \text{max. } 26 \text{ V}$
Output voltage	$U_A = U_N - (0.38 \times I [\text{mA}]) - 0.5$
Maximum current	93 mA DC
Maximum external connection values IIC	0.077 μF ; 4.3 mH
Maximum external connection values IIB	0.39 μF ; 12.6 mH
Ambient temperature	-20 °C to +60 °C (-4 °F to +140 °F)
Relative humidity (IEC 721-3-3)	max. 90 % no condensation
IP rating (EN 60529)	IP 20
Mounting	Mounting rail 35 mm DIN 46277
Mounting location	Safe area / not potentially explosive area
Weight	100 g (0.2 lbs)
Dimensions	20 x 107 x 115 mm (WxHxD) 0.8 x 4.2 x 4.5 inch (WxHxD)

Approvals / marking

Type examination certificate:

BAS 00 ATEX 7087
IECEX BAS 08.0079

Part no.: 901324

Control device for the operation of "intrinsically safe Ex ia" detectors in explosion hazard areas.

The safety barrier limits the power supplied to an intrinsically safe electric circuit in such a way that neither sparks nor thermal effects can cause an ignition.

The intrinsically safe electric circuit of the safety barrier is suitable for zones 0, 1 and 2 as well as zones 20, 21 and 22. VDE0105 Part 9 applies to the operation of electrical systems in potentially hazardous areas.

Application

The safety barrier is connected to a spur line of the detector loop.

The Loop AP protocol interface, part no. 901322, needs to be connected in front of the safety barrier.

Included in delivery

1 Safety barrier Ex Loop AP 24 V

Note

For the interconnection of intrinsically safe detectors to the intrinsically safe electric circuit of the safety barrier, the corresponding maximum values of the detectors need to be observed. The maximum permissible values for capacitive and inductive loads must be complied with. When setting up intrinsically safe electric circuits in explosion hazard areas, the corresponding applicable national and international setup regulations need to be observed.

Connection diagram

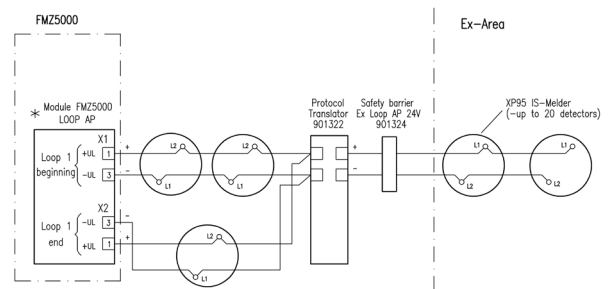

* Optionally the Module Loop AP XP (part no. 906185) or the Module Loop AP XP red (part no. 906186) can be used.



Fire detection and suppression control panels

Accessories

Safety barrier Ex isolated 24 V 2 channel

Part no.: 922689

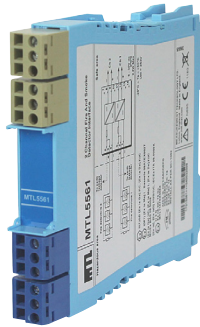

Safety Ballast for operating fire detectors with intrinsically safe ignition protection class "Intrinsically safe" explosion hazard areas. The safety barrier limits the energy fed into an intrinsically safe circuit in such a way that neither sparks nor thermal effects can cause ignition. The safety barrier is an "ia" device suitable for the operation of fire detectors in Ex zones 0, 1 and 2 as well as 20, 21 and 22.

Product features

- Galvanic isolation of the input area from the safety area
- Intrinsically safe electric circuit suitable for Ex zones 0, 1, 2, 21 and 22
- 2 channels
- Ready to connect for mounting on mounting rail TS35

Included in delivery

1 Safety barrier Ex isolated 24 V 2 channel

Note

For the interconnection of intrinsically safe fire detectors with the intrinsically safe circuit of the safety barrier the respective parameters of the fire detectors must be observed. The maximum permissible values for the capacitive and inductive load must be maintained. When setting up intrinsically safe circuits in explosion hazard areas, the valid national and international regulations must be observed.

Technical specifications

Rated voltage	$U_N = \text{max. } 28 \text{ V DC}$
Output voltage	$U_A = U_n - (0,38 \times I [\text{mA}]) - 0,5$
Max. current	93 mA
Max. external connected load IIC	0.083 μF ; 4.2 mH
Max. external connected load IIB	0.65 μF ; 12.6 mH
Ambient temperature	-20 °C to +60 °C (-4 °F to +140 °F)
Relative humidity	max. 90 % no condensation
IP rating (EN 60529)	IP 20
Mounting	Mounting rail 35 mm DIN 46277, top hat profile
Mounting location	safe area / not potentially explosive area
Weight	0.15 kg (0.33 lbs)
Dimensions	105 x 122 x 16 mm (WxHxD) 4.1 x 4.8 x 0.6 inch (WxHxD)

Approvals / marking

Type examination certificate: Baseefa 09 ATEX 0027
IECEX BAS 09.0008





Fire detection and suppression control panels

Accessories

Loop AP protocol interface



Product features

- Connection-ready device for mounting on a TS35 mounting rail (DIN rail)
- No adjustment or maintenance work required
- Spur from Loop AP required

Technical specifications

Operating voltage	19 - 28 V DC
Output voltage	16.5 - 19 V DC
Current consumption input	1 mA DC
Maximum current output	30 mA DC
Current pulse input	8 - 12 mA DC
Current pulse output	17 - 23 mA DC
Operating temperature	-20 °F to +60 °C (-4 °F to +140 °F)
Relative humidity	max. 95 % no condensation
IP rating (EN 60529)	IP 20
Mounting	Mounting rail 35 mm DIN 46277
Site of installation	Secure area / non Ex area
Weight	100 g (0.2 lbs)
Dimensions	20 x 92.5 x 111 mm (WxHxD) 0.8 x 3.6 x 4.4 inch (WxHxD)

Approvals / marking



0832-CPD-0858

Loop AP protocol interface for 2 lines

Technical specifications

Current consumption input	2 mA DC
---------------------------	---------

Part no.: 901322

Control device for the operating of „intrinsically safe Ex i“ detectors in explosion hazard areas together with a safety barrier.

Application

The protocol interface is switched to the detector loop, forming a spur.

After the protocol interface the safety barrier, part no. 901324, must be switched to the spur.

Included in delivery

1 Loop AP protocol interface

Connection diagram

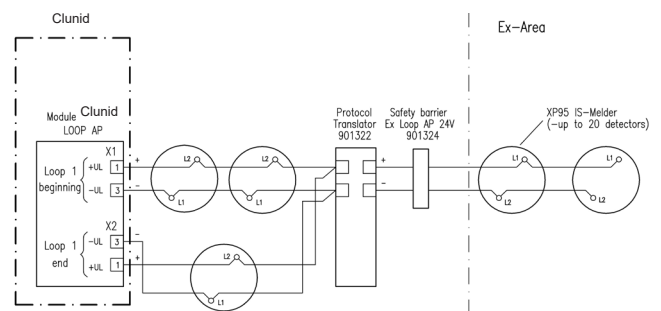

Part no.: 901323

Otherwise like part no.: 901322



Fire detection and suppression control panels

Accessories

Safety barrier SBEx-9



Part no.: 933093

Safety barrier for the operation of detectors type “intrinsically safe” in potentially hazardous areas. The safety barrier limits the power supply to an intrinsically safe electrical circuit that neither sparks nor thermal effects can cause an ignition. The safety barrier is designed as “ib” equipment for the operation of fire detectors in Ex zones 1 and 2 and 21 and 22.

Product features

- Ready for connection and mounting on DIN rail TS35
- No adjustment or maintenance work required
- Intrinsically safe electric circuit suitable for Ex zones 1, 2, 21 and 22

Technical specifications

Rated voltage	$U_N = 9 \text{ V DC}$; max. 10.6 V DC
Output voltage	$U_A = U_{On} - 1.4 \text{ V}$
Rated current	$I_N \leq 95 \text{ mA DC}$
Ambient temperature	-20 °C to +60 °C (-4 °F to +140 °F)
Storage temperature	-40 °C to +60 °C (-40 °F to +10 °F)
Relative humidity	max. 90 % no condensation
IP rating (EN 60529)	IP 20
Mounting	Mounting rail DIN 35 mm (IEC 60715)
Mounting location	Safe area / not potentially explosive area
Weight	approx. 100 g (0.22 lbs)
Dimensions	22.5 x 79 x 85.5 mm (WxHxD) 0.9 x 3.1 x 3.4 inch (WxHxD)

Application

The safety barrier is connected to a conventional line

Included in delivery

1 Safety barrier SBEx-9

Note

The safety barrier is used exclusively for the current and voltage supply of intrinsically safe fire detectors according to IEC 60079-11. The parameters of the fire detectors must be observed. The maximum permissible values for capacitive and inductive loads must be observed. The safety barrier must be connected to the equipotential bonding within the potentially hazardous area. Potential equalization in accordance with IEC 60079-14/EN 60079-14 must exist for all intrinsically safe electric circuits.

When setting up intrinsically safe electric circuits in potentially hazardous areas, the corresponding applicable national and international setup regulations need to be observed.

Connection diagram

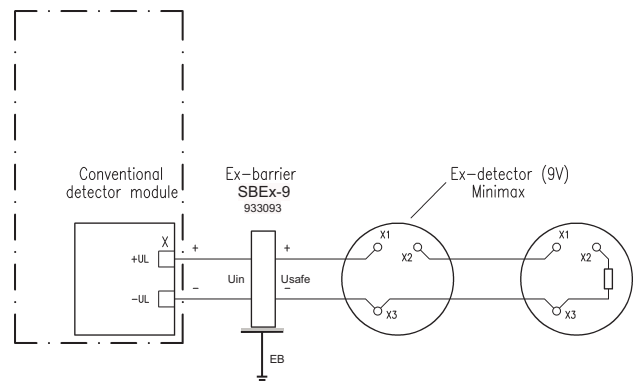

Approvals / marking

Type examination certificate:

TÜV 19 ATEX 8410
IECEX TUR 19.0049





Fire detection and suppression control panels

Modules/cards

Central card

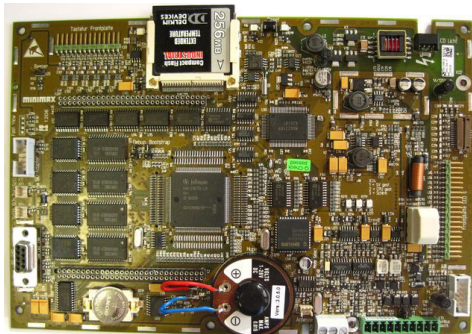

Part no.: 910708

The central control card constitutes the main unit of the FMZ 5000 fire alarm- and extinguishing control panel. Includes all the components for communicating with the modules used in the panel, the front panel for displaying messages and for operating the panel. In addition the firmware and project-related settings for the panel are stored. A licence for the operating system is automatically delivered with each central card.

Technical specifications

Operating voltage	24 V DC \pm 15 %
Quiescent current	approx. 110 mA DC
Operating temperature	- 5 °C to + 40 °C (+23 °F to +104 °F)
Weight	248 g (0.6 lbs)
Dimensions	245 x 165 mm (WxL) 9.7 x 6.5 inch (WxL)
Performance Level acc. to ISO 13849	c

Application

Card exclusively as replacement part to be exchanged for a defective card in an existing FMZ 5000 fire alarm control panel mod 4, mod 12, mod XL 21 HE, mod XL 31 HE or mod XL 40 HE.

Included in delivery

Card complete for exchange in an existing FMZ 5000 fire alarm control panel.

Not included in delivery

CompactFlash memory card 905881
Connection cable, plug, mounting accessories

Spare parts

Encoding connector AKSN/G (Jumper) 805412

Note

When swapping out the card take all ESD precautions. In each case before exchanging the card, turn off the panel and disconnect from mains voltage. Observe correct seating of the foil connections to the front foil and the ribbon cable plugs. Remove the CompactFlash memory card from the defective central card. You may have to insert a new memory card provided by Minimax. In this case the configuration data must be loaded directly onto the new card or via download using the MxSysCon configuration program. The central card contains the latest version of the firmware. In each case the compatibility of the firmware with the version of all in the panel installed modules and of the configuration data on the memory card must be checked.

Approvals / marking

See panels





Fire detection and suppression control panels

Modules/cards

Central card redundant

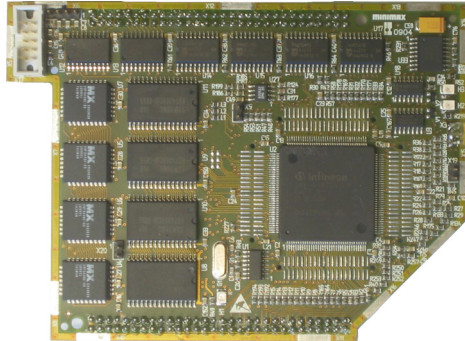

Part no.: 910707

Card for achieving the processor redundancy in compliance with EN54-2 and VdS2095 if during application of the control panel at least one of the following cases applies:

- More than 512 detectors are connected
 - The monitored area is larger than 12.000 m² (1.435 ft²)
 - More than one extinguishing zone is triggered.
- The card is inserted into the plug strips X1 and X2 of the central card.

Technical specifications

Weight	70 g (0.2 lbs)
Dimensions	135 x 100 x 20 mm (WxLxH) 5.3 x 3.9 x 0.8 inch (WxLxH)

Spare parts

Coding plug AKSN/G (jumper)

805412

Approvals / marking

See panels

CompactFlash 256 MB memory card



Part no.: 905881

CompactFlash memory card with ATA communications interface and 256 MByte capacity for use in the FMZ 5000 control card. The card has an extended temperature range of -40 °C to +85 °C (-40 °F to 185 °F).

The card is used for saving current and past states of the fire alarm- and extinguishing control panel.

It is also used to store the control panels configuration data. Apart from the control unit the card can be read or written to with any memory card reading device.

Technical specifications

Memory capacity	min. 256 MB
Operating temperature	-40 °C to +85 °C (-40 °F to +185 °F)
Relative humidity (IEC 721-3-3)	max. 95 % no condensation
Mounting	In socket on the fire alarm central card
Weight	9 g (0.02 lbs)
Dimensions	42 x 36 x 4 mm (WxLxH) 1.7 x 1.4 x 0.2 inch (WxLxH)

Included in delivery

256 MB CompactFlash memory card without data

Not included in delivery

Read/write device for external reading or writing

Note

The CompactFlash memory card should be formatted before first use. Only those CompactFlash memory cards with the extended temperature range are authorized for use in the FMZ 5000. This memory card may only be used with the Central card release 4.



Fire detection and suppression control panels

Modules/cards

Zone operating panel card

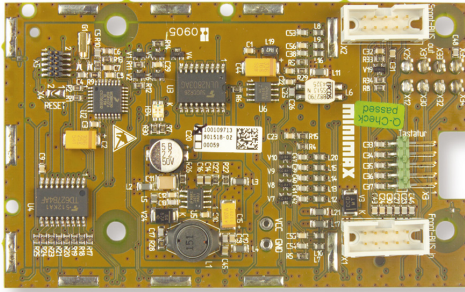

Part no.: 901518

Card for use in all design variants of the FMZ 5000 fire detection and suppression control panel series. Includes 16 groups with one red and one yellow LED each and 4 membrane keys with freely configurable function. In addition there are 4 connections for uses such as key-operated switches on the front plate. Labeling is by means of sliding labels behind transparent windows - at front plate BBF, one window per zone operating panel, LED group and membrane key.

Product features

- Each LED can be configured for indication by steady light, flashing and rapid flashing
- Each membrane key can be used as a switching actuator or a momentary-contact actuator
- All settings are carried out with the MxSysCon configuration program
- No adjustment work is required

Technical specifications

Operating voltage	19 V - 29 V DC
Quiescent current	10 mA DC
Ambient temperature	-5 °C to +40 °C (+23 °F to +104 °F)
Relative humidity (IEC 721-3-3)	max. 95 % no condensation
Mounting	On the rear side of the front plate
Weight	40 g (0.1 lbs)
Dimensions	70 x 113 mm (WxH) 2.8 x 4.5 inch (WxH)

Application

For displaying individual indications of signals, faults, activations, shutdowns etc.
Up to 27 cards can be used in one fire alarm panel.

Included in delivery

Card, separate or as part of a complete retrofit kit including mounting accessories for installation behind the front plate.	
Complete retrofit kit	903340
includes:	
Zone operating panel card	901518
Mounting accessories	904981
Artwork master 50 BBF	903282

Not included in delivery

Front plate FMZ 5000 BBF	901733
--------------------------	--------

Note

Connected switches/buttons must not be fitted outside the central fire alarm system.

Approvals / marking

See panels



Fire detection and suppression control panels

Modules/cards

Module COM Server LC

**Part no.: 927633**

Functional module for use in all design variants of the fire detection system FMZ 5000. The Module COM Server LC integrates a serial device into the network via TCP/IP Ethernet for industrial use. For communication the standard network services can be used.

Product features

- 1x RS232-/RS422-/RS485-Interface, switchable
- D-SUB plug 9-pole
- 1x Ethernet 10/100BaseT (Autosensing/Auto-MDIX)

Technical specifications

Operating voltage	12 - 48 V DC 18 - 30 V AC effective
Current consumption max.	55 mA DC at 24 V
Outputs	1x RS232-, RS422-, RS485- interface, switchable, DB9-plug 50 to 57.600 Baud 7.8 Data bit 1.2 Stop bit Parity No, Even, Odd, Mark, Space Flow control No, RTS/CTS, Xon/Xoff
Operating modes	RS232 RS422 4-wire-bus-master RS485 4-wire-bus-master RS485 4-wire-automatic control RS485 2-wire-automatic control
Network	10/100BaseT Autosensing
Operating temperature	0 °C to + 60 °C (+32 °F to +140 °F)
Storage temperature	-40 °C to + 70 °C (-40 °F to + 158 °F)
Relative humidity (IEC 721-3-3)	max. 95 % no condensation
IP rating (EN 60529)	IP 20
Installation position	vertical
Mounting	Mounting rail 35 mm DIN 46277, top hat profile
Weight	105 g (0.23 lbs)
Dimensions	22 x 75 x 105 mm (WxHxD) 0.8 x 2.9 x 4.1 inch (WxHxD)

Application

The Module COM Server LC enables the Ethernet connection of a fire detection control panel FMZ 5000 to

- a PC/server with the Inveron Hazard management system,
- a OPC server for further universal data exchange

or

- any Ethernet-/Fast Ethernet network

The module must be connected serially via a Module MxNet as an additional network node or directly to a Module SIO in a fire detection control panel.

Included in delivery

Module completely assembled and ready for installation in the fire detection control panel.

Not included in delivery

Use of the Module COM Server LC in a FMZ 5000 fire detection control panel requires additionally a:

- Module FMZ 5000 SIO1 903466
- or
- Module FMZ 5000 SIO3 903467
- or one Module FMZ 5000 MxNet 904877

For serial connection of the Module COM Server LC to a Module SIO, the Null Modem Adapter D-Sub 9-pole, part no. 927634, is to be used.

Approvals / marking

The Module COM Server LC is part of the approved components

- in the CPR approval of the FMZ 5000 as fire detection panel according to EN 54-2/EN 12094-1
- in the VdS device approval of the FMZ 5000 as fire detection panel





Fire detection and suppression control panels

Modules

Module Class A initiating device

**Part no.: 933474**

Function module for a loop-shaped connection of detectors in conventional technology to a conventional group.
For installation according to US-American standards in e.g. water extinguishing systems.

Product features

- The spur line "In" of a conventional group is converted into a loop "Loop Out/In"
(Corresponds to Class A Style D and E in FM extinguishing systems)
- In the case of a simple wire break all detectors are still connected by an automatic switchover
- After removal of the wire break, followed by a reset pulse longer than 1 second on the conventional line "In", the module will be reset
(the optional reset input is not required)
- Optional reset input for a module reset after a wire break with manufacturer compatible conventional groups. No external reset permitted.

Included in delivery

Module completely assembled, ready for installation.

Note

Each module may be operated only with detectors produced by the same manufacturer.

Technical specifications

Operating voltage	12 V - 24 V DC
Quiescent current	10 mA DC
Detector group current	max. 300 mA DC
Number of detector groups	1
Number of loops	1
Number of detectors	32 (VdS) / 50 (NFPA)
Max. terminal cross-section	2.5 mm ² (AWG 14)
Ambient temperature	-5 °C to +55 °C (+23 °F to +131 °F)
Storage temperature	-10 °C to +80 °C (+14 °F to +176 °F)
Relative humidity	max. 95 % no condensation
IP rating (EN 60529)	IP 20
Enclosure	Polyamide PA6.6, green
Installation position	any
Mounting	Mounting rail 35 mm DIN 46277
Weight	60 g (0.13 lbs)
Dimensions	19 x 81 x 70 mm (WxHxD) 0.75 x 3.19 x 2.76 inch (WxHxD)

Connection diagram

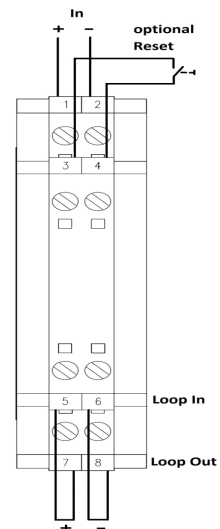

Approvals / marking

See panels



Fire detection and suppression control panels

FMZ 5000 enclosure/front plates

Front plate FMZ 5000 BBF



Part no.: 901733

Front plate for housing up to five zone operating panels. Has 16 red/yellow LED pairs and four membrane keys for each panel.

Labeling fields as headers for each zone operating panel and one labeling field for each LED pair, designed to accept sliding labels.

Technical specifications

Color	RAL 7035
Material	Aluminium
Weight	750 g (1.7 lbs)
Dimensions	19" x 4U (WxH)

Not included in delivery

Card FMZ 5000 zone operating panel	901518
Add-on kit FMZ 5000 front panel BBF	904119
Retrofit kit FMZ 5000 BBF	903340
Pan-head screw with washer M6 x 16	607284
Cable set front plate extension	903942

Front plate FMZ 5000 printer AP 1200



Part no.: 906231

Front plate with breakout for mounting a Printer AP 1200 in a FMZ 5000 mod 12 or mod XL.

Technical specifications

Color	RAL 7035
Material	Aluminium
Weight	750 g (1.7 lbs)
Dimensions	19" x 4U (WxH)

Included in delivery

Front plate complete for mounting in a FMZ 5000.

Not included in delivery

Nut KM6 „cage nut“	138670
Pan-head screw with washer M6 x 16	607284



Fire detection and suppression control panels

FMZ 5000 enclosure/front plates



Dummy plate 1U

Part no.: 905492

Technical specifications

Color	RAL 7035
Material	Aluminium
Weight	190 g (0.4 lbs)
Dimensions	19" x 1U (WxH)

Dummy plates for covering unused areas on the front of panel enclosures FMZ 5000 mod 12 and mod XL.

Not included in delivery

Pan-head screw with washer M6 x 16	607284
Nut KM6 „cage nut“	138670

Dummy plate 2U

Part no.: 902411

Technical specifications

Color	RAL 7035
Material	Aluminium
Weight	360 g (0.8 lbs)
Dimensions	19" x 2U (WxH)

Dummy plates for covering unused areas on the front of panel enclosures FMZ 5000 mod 12 and mod XL.

Not included in delivery

Pan-head screw with washer M6 x 16	607284
Nut KM6 „cage nut“	138670

Dummy plate 3U

Part no.: 902412

Technical specifications

Color	RAL 7035
Material	Aluminium
Weight	540 g (1.2 lbs)
Dimensions	19" x 3U (WxH)

Dummy plates for covering unused areas on the front of panel enclosures FMZ 5000 mod 12 and mod XL.

Not included in delivery

Pan-head screw with washer M6 x 16	607284
Nut KM6 „cage nut“	138670

Dummy plate 4U

Part no.: 902413

Technical specifications

Color	RAL 7035
Material	Aluminium
Weight	765 g (1.7 lbs)
Dimensions	19" x 4U (WxH)

Dummy plates for covering unused areas on the front of panel enclosures FMZ 5000 mod 12 and mod XL.

Not included in delivery

Pan-head screw with washer M6 x 16	607284
Nut KM6 „cage nut“	138670



Fire detection and suppression control panels

FMZ 5000 enclosure/front plates

FMZ 5000

Dummy plate 5U

Part no.: 902414

Technical specifications

Color	RAL 7035
Material	Aluminium
Weight	895 g (2 lbs)
Dimensions	19" x 5U (WxH)

Dummy plates for covering unused areas on the front of panel enclosures FMZ 5000 mod 12 and mod XL.

Not included in delivery

Pan-head screw with washer M6 x 16	607284
Nut KM6 „cage nut“	138670



Fire detection and suppression control panels

Power supply units

Power supply unit NT5100 3A

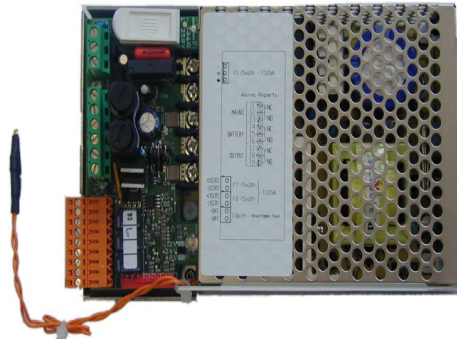

Part no.: 908452

The power supply unit is used for the uninterrupted power supply of the following:

- Fire detection panels FMZ 5000 mod 4 / 12
- Other external devices with a rated operating voltage of 24V DC

Temperature-controlled battery charging for 2 batteries 12 V max. 26 Ah. Connected batteries are continuously monitored by measuring the internal resistance. The output voltage is short-circuit proof. Also monitoring on power failure, surge protection, fuse failure and reverse polarity of the batteries. Collective fault report by potential free relays.

Technical specifications

Mains voltage	115 V / 230 V ±15% AC
Mains frequency	50 Hz - 60 Hz
Output voltage	21 V - 27.2 V DC
Output current I _{max b}	3 A DC
Battery capacity	2 x 12 V / 7.2 Ah to 26 Ah
Ambient temperature	- 5°C to + 50 °C (+23 °F to +122 °F)
Specification according to	EN 54-4
Weight	0.8 kg (1.8 lbs)
Dimensions	185 x 105 x 65 mm (WxHxD) 7.3 x 4.1 x 2.6 inch (WxHxD)

Included in delivery

Power supply unit completely assembled and ready for installation in the device on mounting rail.

Not included in delivery

Spare fuse 3.15 A / 250 V

908576

Approvals / marking



0333-CPR-075373





Fire detection and suppression control panels

Power supply units

Power supply unit NT5000 5A



Technical specifications

Mains voltage	115 V / 230 V -15%, +10% AC
Mains frequency	50 Hz - 60 Hz
Output voltage	21 V - 29 V DC
Output current I _{max b}	5 A DC
Battery capacity	2 x 12 V / 7.2 Ah to 45 Ah
Ambient temperature	-5 °C to +50 °C (-4 °F to +122 °F)
Specification according to	EN 54-4
Weight	1.3 kg (2.9 lbs)
Dimensions	190 x 129 x 103 mm (WxHxD) 7.5 x 5.1 x 4.1 inch (WxHxD)

Part no.: 901037

The power supply unit is used for uninterrupted power supply of the following:

- Fire alarm panels FMZ 5000 mod 12 / XL
- Other external devices

with a rated operating voltage of 24V DC

Temperature-controlled battery charging for 2 batteries 12 V max. 40 Ah. Charging characteristics are adjustable for different battery types.

Connected batteries are continuously monitored.

The output voltage is short-circuit proof.

Common fault indication as GND switching relay output.

Included in delivery

Power supply unit completely assembled and ready for installation in the device on mounting rail.

Not included in delivery

Spare fuse 15 A

891423

Note

The power supply unit and the batteries must be selected according to the table at the end of the chapter.

Approvals / marking



G 204140



0786-CPD-20360



Power supply unit NT5000 15A



Technical specifications

Mains voltage	115 V / 230 V -15%, +10% AC
Mains frequency	50 Hz - 60 Hz
Output voltage	21 V - 29 V DC
Output current I _{max b}	15 A DC
Battery capacity	2 x 12 V / 18 Ah to 115 Ah
Ambient temperature	-5 °C to +50 °C (-4 °F to +122 °F)
Specification according to	EN 54-4
Weight	3.2 kg (7.1 lbs)
Dimensions	250 x 150 x 103 mm (WxHxD) 9.8 x 5.9 x 4.1 inch (WxHxD)

Part no.: 901038

The power supply unit is used for uninterrupted power supply of the following:

- Fire alarm panels **FMZ 5000 XL**
- Other external devices with a rated operating voltage of 24V DC

Temperature-controlled battery charging for 2 batteries 12 V max. 115 Ah. Charging characteristics are adjustable for different battery types.

Connected batteries are continuously monitored.

The output voltage is short-circuit proof.

Common fault indication as GND switching relay output.

Included in delivery

Power supply unit completely assembled and ready for installation in the device on mounting rail.

Not included in delivery

Spare fuse 20 A

904021

Note

The power supply unit and the batteries must be selected according to the table at the end of the chapter.

Approvals / marking



G 204139



0786-CPD-20282





Fire detection and suppression control panels

Power supply units

Power supply unit HMA30 S05



Part no.: 904769

Power supply unit for a printer FMZ 5000 AP 1200.
The power supply unit is mounted on the DIN rail with terminals for mains connection.

Included in delivery

Power supply unit completely assembled and ready for installation in the device on mounting rail.

Not included in delivery

Installation material

Technical specifications

Mains voltage	90 V - 264 V AC / 50 - 400 Hz
Mains frequency	50 Hz - 60 Hz
Output voltage	5 V DC
Output current I_{max}	3 A DC
Ambient temperature	-0°C to +50 °C (+32 °F to +122 °F)
Weight	0.4 kg (0.8 lbs)
Dimensions	35 x 113 x 70 mm (BxHxT) 1.4 x 4.4 x 2.7 inch (BxHxT)



Fire detection and suppression control panels

Power supply units

Power supply AESI 2403



Part no.: 926088

Battery packed failsafe power supply unit for a decentralized and uninterrupted power supply for external 24 V loads e.g. aspirating smoke detectors, sounders etc.

Included in delivery

Complete power supply, ready for installation and operation.

Not included in delivery

Batteries 12 V

Approvals / marking



G513008



0786-CPR-50642

Technical specifications

Mains voltage	115 - 240 V AC
Output voltage	24 V DC
Output current	max. 3 A
Battery capacity	2 x 12 V / 17 Ah - 26 Ah
Fuse board	6 outputs with 1 A each
Ambient temperature	-5 °C to +55 °C (+23 °F to +131 °F)
Storage temperature	-25 °C to +85 °C (-13 °F to 185 °F)
Relative humidity	20 to 95 % no condensation
Weight	5 kg (11.02 lbs)
Dimensions	289 x 350 x 189 mm (WxHxD) 11.4 x 13.8 x 7.4 inch (WxHxD)
Max. installation height above sea level	2000 m (1.24 miles)



Fire detection and suppression control panels

Power supply units

Power supply AES 2406

**Part no.: 926089**

Battery packed failsafe power supply unit for a decentralized and uninterrupted power supply for external 24 V loads e.g. aspirating smoke detectors, sounders etc.

Included in delivery

Complete power supply, ready for installation and operation.

Not included in delivery

Batteries 12 V

Approvals / marking

G209036



0333-CPR-075526

Technical specifications

Mains voltage	230 V AC \pm 15%
Output voltage	24 V DC
Output current	max. 6 A
Battery capacity	2 x 12 V / 24 Ah - 38 Ah
Fuse board	6 outputs with 1 A each
Ambient temperature	-5 °C to +40 °C (+23 °F to +104 °F)
Storage temperature	-25 °C to +85 °C (+77 °F to +185 °F)
Relative humidity	20 to 95 % no condensation
Weight	9 kg (19.84 lbs)
Dimensions	408 x 408 x 224 mm (WxHxD) 16.1 x 16.1 x 8.8 inch (WxHxD)
Max. installation height above sea level	2000 m (1.24 miles)



Fire detection and suppression control panels

Batteries



Battery 2.3 Ah

Technical specifications

Connection	Blade terminal T1 4.8 mm (0.19 inch)
Weight	0.97 kg (2.14 lbs)
Dimensions	178 x 35 x 66 mm (LxWxH) 7 x 1.4 x 2.6 inch (LxWxH)

Part no.: 4003368

Included in delivery

1 Battery 12 V / 2.3 Ah

Approvals / marking



Battery 7.2 Ah

Technical specifications

Connection	Blade terminal T1 4.8 mm (0.19 inch)
Weight	2.3 kg (5.1 lbs)
Dimensions	151 x 65 x 99 mm (LxWxH) 5.9 x 2.6 x 3.9 inch (LxWxH)

Part no.: 927122

Included in delivery

1 Battery 12 V / 7.2 Ah

Approvals / marking



Battery 12 Ah

Technical specifications

Connection	Blade terminal T1 4.8 mm (0.19 inch)
Weight	3.8 kg (8.4 lbs)
Dimensions	151 x 98 x 101 mm (LxWxH) 5.9 x 3.9 x 4.0 inch (LxWxH)

Part no.: 927481

Included in delivery

1 Battery 12 V / 12 Ah

Approvals / marking



Battery 18 Ah

Technical specifications

Connection	T3 M6
Weight	5.7 kg (12.6 lbs)
Dimensions	181 x 77 x 182 mm (LxWxH) 7.1 x 3.0 x 7.2 inch (LxWxH)

Part no.: 927123

Included in delivery

1 Battery 12 V / 18 Ah
Pole adapter M6 to 6.3 mm

Approvals / marking





Fire detection and suppression control panels

Batteries

Battery 26 Ah

Part no.: 927125

Technical specifications

Connection	T12 M5
Weight	8 kg (17.6 lbs)
Dimensions	166 x 175 x 125 mm (LxWxH) 6.5 x 6.9 x 4.9 inch (LxWxH)

Included in delivery

1 Battery 12 V / 26 Ah
Pole adapter M5 to 6.3 mm

Approvals / marking



Battery 45 Ah

Part no.: 927126

Technical specifications

Connection	T6 M6
Weight	14.4 kg (31.8 lbs)
Dimensions	197 x 165 x 170 mm (LxWxH) 7.8 x 6.5 x 6.7 inch (LxWxH)

Included in delivery

1 Battery 12 V / 45 Ah
Pole adapter M6 to 6.3 mm

Approvals / marking



Battery 65 Ah

Part no.: 927124

Technical specifications

Connection	T6 M6
Weight	21.5 kg (47.4 lbs)
Dimensions	348 x 167 x 178 mm (LxWxH) 13.7 x 6.6 x 7.0 inch (LxWxH)

Included in delivery

1 Battery 12 V / 65 Ah
Pole adapter M6 to 6.3 mm

Approvals / marking



Battery 85 Ah

Part no.: 801758

Technical specifications

Connection	conical pin
Weight	31.0 kg (68.3 lbs)
Dimensions	330 x 232 x 171 mm (LxWxH) 13 x 9.7 x 6.7 inch (LxWxH)

Included in delivery

1 Battery 12 V / 85 Ah

Accessories

Battery connector

907907

Approvals / marking



Battery 100 Ah

Part no.: 927127

Technical specifications

Connection	T11 M8
Weight	32,0 kg (70.6 lbs)
Dimensions	330 x 173 x 220 mm (LxWxH) 13.0 x 6.8 x 8.7 inch (LxWxH)

Included in delivery

1 Battery 12 V / 100 Ah
Pole adapter M8 to 6.3 mm

Approvals / marking





Fire detection and suppression control panels

Batteries

Battery 115 Ah

Part no.: 800775

Technical specifications

Connection	conical pin
Weight	40.3 kg (88.9 lbs)
Dimensions	286 x 269 x 230 mm (LxWxH) 11.3 x 10.6 x 9.1 inch (LxWxH)

Included in delivery

1 Battery 12V / 115 Ah

Accessories

Battery connector

907907



Fire detection and suppression control panels

FMZ 5000 base unit

Overview of alternative power supply unit and maximum battery capacity per control panel

	VdS	FM	FMZ 5000 mod 4	FMZ 5000 mod 12	FMZ 5000 mod XL		
					21 HE	31 HE	40 HE
NT5000 5 A (Part no. 901037)	X	X	---	26 Ah	45 Ah*	45 Ah*	45 Ah*
NT5000 15 A (Part no. 901038)	X	X	---	26 Ah	65 Ah	115 Ah* and 130 Ah**	115 Ah* and 130 Ah**
NT5100 3 A (Part no. 908452)	X	---	12 Ah	26 Ah*	---	---	---

* Battery in combination with power supply unit without VdS approval

** Based on two power supply units or parallel connection 4 x 65 Ah

For batteries from 2 x 85 Ah or 4 x 65 Ah, a heavy-duty pivot frame must be used

Overview of alternative batteries for power supply units

	NT5000 5 A (Part no. 901037)	VdS/ EN 54-4	NT5000 15 A (Part no. 901038)	VdS/ EN 54-4	NT5100 3 A (Part no. 908452)	VdS/ EN 54-4
Battery 2,1 Ah (Part no. 927121)	---	---	---	---	---	---
Battery 7,2 Ah (Part no. 927122)	X	X	---	---	X	X
Battery 12 Ah (Part no. 927481)	X	X	---	---	X	X
Battery 18 Ah (Part no. 927123)	X	X	X	X	X	X
Battery 26 Ah (Part no. 927125)	X	X	X	X	X	---
Battery 45 Ah (Part no. 927126)	X	---	X	X	---	---
Battery 65 Ah (Part no. 927124)	---	---	X	X	---	---
Battery 85 Ah (Part no. 801758)	---	---	X	X	---	---
Battery 100 Ah (Part no. 927127)	---	---	X	---	---	---
Battery 115 Ah (Part no. 800775)	---	---	X	---	---	---



Fire detection and suppression control panels

FMZ 5000 fire detection panel accessories

Ribbon cable 10 wire

Part no.: 853805

Technical specifications

Weight	18 g/m (0.04 lbs/m)
--------	---------------------

Quantity unit for orders = meters

Ribbon cable, round, shielded 20 wire

Part no.: 800315

Technical specifications

Weight	118 g/m (0.3 lbs/m)
--------	---------------------

Quantity unit for orders = meters

Ribbon cable shielded 20 wire

Part no.: 784157

Technical specifications

Weight	43 g/m (0.09 lbs/m)
--------	---------------------

Quantity unit for orders = meters

Female connector 2 x 5 pol.

Part no.: 796759

Technical specifications

Weight	1 g (0.002 lbs)
--------	-----------------

Female connector 2 x 10 pol.

Part no.: 784170

Technical specifications

Weight	3 g (0.007 lbs)
--------	-----------------

Plug pressure compensation PG 29

Part no.: 905417

Technical specifications

Air inlet surface	1.5 cm ² (0.23 inch ²)
-------------------	---

Weight	3 g (0.007 lbs)
--------	-----------------

Ventilation for battery systems



Fire detection and suppression control panels

FMZ 5000 fire detection panel accessories

Cable set FMZ 5000 mod S Relay card

Part no.: 913673

Technical specifications

Weight	6 g (0.01 lbs)
--------	----------------

1 Cable set complete with socket

Cable set FMZ 5000 Front plate extension

Part no.: 903942

Technical specifications

Weight	33 g (0.07 lbs)
--------	-----------------

1 Cable set complete with socket

Cable set FMZ 5000 mod XL Module extension

Part no.: 905113

Technical specifications

Weight	192 g (0.4 lbs)
--------	-----------------

1 Cable set complete with socket and ferrite core



Fire detection and suppression control panels

FMZ 5000 fire detection panel accessories

Fire protection housing F 30 FMZ 5000 mod 12



Product features

- Tailored fire protection housing for FMZ 5000 mod 12
- Enclosure with integrated passive airing system in door and enclosure top
- Certified protection housing in accordance to DIN 4102-2
- Panel specific cable glance grid through incombustible basic fire protection plate according to EN 13501-A2
- 4 integrated mounting points and specific FMZ 5000 mod 12 mounting plate

Technical specifications

Specifications	functional integrity 30 minutes - according to E 30 fire resistance 30 minutes - according to F 30 fire load insulation 30 minutes - according to I 30
Source and disposition	based on ABZ-no. Z-86.1-5 based on ABZ-no. Z-86.1-10
Enclosure	composite material
Dimensions	outside: 978 x 828 x 395 mm (WxHxD) 38.50 x 32.59 x 15.55 inch (WxHxD) inside: 800 x 650 x 300 mm (WxHxD) 31.96 x 25.59 x 11.81 inch (WxHxD)
IP rating (EN 60529)	IP 54, protection class II
Color	similar to RAL 7035
Weight	approx. 105 kg (231.48 lbs)
Mounting	Wall-mounted installation (Fastening with rear panel)

Part no.: 917789

The fire protection housing is intended for use in areas where according to MLAR (chapter 3.2.2) the FMZ 5000 (electric distributor) must be separated from passageways, staircases as well as outdoor exits and the use of distributors for electrical circuit systems with functional integrity for 30 minutes (cable routing E 30) is required.

Included in delivery

Fire protection housing F 30
Mounting hardware: screws and dowels

Not included in delivery

Lock cylinder fire protection housing F 30 918146

Note

The fire protection housing F 30 has a left-hinged door stop with hidden steal hinges for free access to the fire alarm and control panel during commissioning and maintenance. The fire protection housing can be opened using a swivelling lever in which a DIN half cylinder can be retrofitted. If access level 1 according to DIN 54-2 (without specific procedures) is required, then the lock cylinder fire protection housing F 30 (part no. 918146) must be used instead of the standard keys provided. Additional installation of fire detectors inside the enclosure is possible.

Fire protection housing F 30 FMZ 5000 mod 4

Technical specifications

Dimensions	outside: 728 x 728 x 345 mm (WxHxD) 28.66 x 28.66 x 13.58 inch (WxHxD) inside: 550 x 550 x 250 mm (WxHxD) 21.65 x 21.65 x 9.84 inch (WxHxD)
Weight	approx. 71 kg (156.52 lbs)

Part no.: 917788

Otherwise like part no.: 917789

301-590_002 / A101_2016en
The contents of this publication are subject to modifications without notice. All rights reserved.
1/1





Fire detection and suppression control panels

FMZ 5000 fire detection panel accessories

Key set BMA control panel



Technical specifications

Weight	90 g (0.2 lbs)
--------	----------------

Part no.: 917687

Key set for all FMZ 5000 fire detection and suppression control panels and connected peripheral equipment.

Product features

- Allows access to fire detection and alarm control panels of the FMZ 5000 series
- Allows access to manual call point
- Allows access to „Zonecheck“

Included in delivery

- 1 „D“ shape door key
- 1 Key FMZ 5000 mod XL / mod 12 / mod S
- 1 Key FMZ 5000 mod XL, pivoting frames
- 1 Key FMZ 5000 mod 12, internal door
- 1 Key FMZ 5000 mod S, front panel
- 1 Reset key DMX SA
- 1 Reset key KAX
- 1 Key Zonecheck and
- 1 Key ring 16 mm (0.63 inch)



Fire detection and suppression control panels

Accessories

Cable loom FMZ 5000 mod S relaycard

Part no.: 913673

Technical specifications

Weight	6 g (0.01 lbs)
--------	----------------

1 Cable loom complete with female headers.

Wiring harness 10 pol. L700 2 socket st.

Part no.: 903942

Technical specifications

Length	700 m (765.53 yd)
Weight	33 g (0.07 lbs)

1 Wiring harness complete with 2x IDC-female headers.

Cable kit FMZ 5000 mod XL module extent.

Part no.: 905113

Technical specifications

Weight	192 g (0.42 lbs)
--------	------------------

1 Cable kit complete with female headers and ferrite core.



Fire detection and suppression control panels

FMZ 4100 cards

Relay expansion card 8TQ

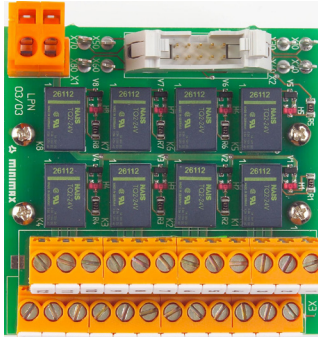

Application

- Each relay can be activated separately
- Activation of a relay is displayed by its own LED
- Wires can also be connected the soldering terminals for direct activation of the relays
- All settings are implemented with the configuration program of the control unit in which the card is inserted
- No adjustments are necessary

Technical specifications

Mains voltage	21 V - 29 V DC
Quiescent current	0 mA DC
No. of relays	8
Current per relay	6 mA (relay activated)
Contact load	0.5 A / 60 V AC, 1 A / 30 V DC
Contact rating	max. 30 W / 62.5 VA
Contacts per relay	1 changeover contacts, potential-free
Terminal cross-section	max. 4 mm ² (AWG 13)
Ambient temperature	-5 °C to +40 °C (+23 °F to +104 °F)
Relative humidity (IEC 721-3-3)	max. 95 % no condensation
Enclosure	Mounting rail 35 DIN 46277, top hat profile
Weight	96 g (0.21 lbs)
Dimensions	70 x 68 x 48 mm (WxLxD) 2.8 x 2.7 x 1.9 inch (WxLxD)

Part no.: 800843

Relay expansion card for use in all variants of the FMZ 5000 control panel. Contains 8 relays with freely configurable function. One changeover contact per relay is connected to the connecting terminal. The relays are actuated via a 0 V signal via the ribbon cable or the wires to the soldering terminals.

Product features

For further notification of any state messages or triggering of unmonitored loads.

Card can be used per relay module in the FMZ 5000. In the FMZ 5000 mod S card can be connected to the mainboard.

Included in delivery

Card with mounting brackets for mounting on a mounting rail

Not included in delivery

Ribbon cable 10-wire (bulk stock)	853805
Female connector 2 x 5 pol.	796759
Cable set FMZ 5000 mod S Relaycard	913673

Note

The relay contacts are not suitable for switching 230 V AC mains voltage

Approvals / marking





Inveron - Hazard Management System

Inveron Basic



Product features

- Hazard Management System
- Client / server system
- Up to 5.000 data points
- Up to 5 interfaces
- Up to 5 workplaces

System requirements

Server

Processor	min. Intel® Xeon™E3-1230Lv3 1.8Ghz Quad-Core CPU
Main memory	min. 8 GB ECC DDR3, 1600 MHz
Hard drive	2 TB SATA3 (1 x 2 TB) HDD*
Network	1 Gbit NIC
Operating system	min. Windows Server 2012 R2 (64 Bit), Windows Server 2008 R2 (64 Bit)

* The required memory location depends upon system use and system settings. For operating an Inveron server a min. of 100GB free hard disk space is required.

Workstation

Processor	min. Intel® Core™ i5-4570 3.2Ghz Quad-Core CPU
Main memory	8 GB DDR4 , 2.400 MHz
Hard drive	1GB SATA3 (6Gb/s) HDD**
Graphics	1GB PCIe Graphics Card
Network	1 Gbit NIC
Operating system	Windows 10 Pro (64 Bit), Windows 8.1 Pro (64 Bit), Windows 7 Pro (64 Bit)

** The required memory location depends upon system use and system settings. For operating an Inveron workstation a minimum of 50Gb free disk space is required.

Application

Hazard Management System for implementation of fire detection and extinguishing systems with easy and standardized operation. Visualization of data points for rapid localization of fire events and incidents. Efficient and automated printout of firefighter routing cards straight from the system.

Included in delivery

Software license

Selection chart

Option	Quantity
Software license	
100 Datapoint Units	
1000 Datapoint Units	
Voice and Fax Notification	
Email Notification	
SMS Notification	
Virtual Module	
Scheduler	
Facility Manager	
User Management plus (LDAP, Active Directory, Single On)	
CAD Support plus	
Mobile App (concurrent user lic. / iOS or Android)	
Webclient (concurrent user lic.)	
Client	
Editor (Project data editor for graphics, workflow,-datapoints, etc.)	
Multi Monitor Support (for up to four monitors at the client)	
Interface (existing)	



Inveron - Hazard Management System

Inveron Express



Product features

- Hazard Management System
- Stand-alone system
- Up to 3.000 data points
- Up to 3 interfaces

System requirements

Workstation

Processor	min. Intel® Core™ i5-4570 3.2Ghz Quad-Core CPU
Main memory	8 GB DDR4 , 2.400 MHz
Hard drive	1GB SATA3 (6Gb/s) HDD**
Graphics	1GB PCIe Graphics Card
Network	1 Gbit NIC
Operating system	Windows 10 Pro (64 Bit), Windows 8.1 Pro (64 Bit), Windows 7 Pro (64 Bit)

** The required memory location depends upon system use and system settings.
For operating an Inveron workstation a minimum of 50Gb free disk space is required.

Application

Hazard management system for implementation of fire detection and extinguishing systems with easy and standardized operation. Visualization of data points for rapid localization of fire events and incidents. Efficient and automated printout of firefighter routing cards straight from the system.

Included in delivery

Software license

Selection chart

Option	Quantity
Software license	
100 Datapoint Units	
1000 Datapoint Units	
Voice and Fax Notification	
Email Notification	
SMS Notification	
Virtual Module	
CAD Support plus	
Mobile App (concurrent user lic. / iOS or Android)	
Interface (existing)	



Monitoring and release devices

Chapter 02



Monitoring and release devices Water-based suppression systems - components

Limit switch ÜWA FMZ - M20x1,5



Part no.: 790400 [Limit switch, red]
Part no.: 880214 [Limit switch, black]

Details see Product sheet water M2-05-05 part 1 and part 2

Pressure switch ÜWA PMÜ-3



Part no.: 792183

Details see Product sheet water M2-05-06 part 2

Pressure switch ÜWA PMÜ-10



Part no.: 810564

Details see Product sheet water M2-05-06 part 2

Pressure switch alarm PMS-3, PMS-10 and PMS-16



Part no.: 817492 [Pressure switch PMS-3]
Part no.: 817509 [Pressure switch PMS-10]
Part no.: 844744 [Pressure switch PMS-16]

Details see Product sheet water M2-04-02 part 2

Pressure switch PS40 and PS120



Part no.: 850855 [Pressure switch PS40]
Part no.: 910029 [Pressure switch PS120]

Details see Product sheet water M2-65-06 part 1



Monitoring and release devices

Water-based suppression systems - components

Float switch for monitoring

Part no.: 879475 [Float switch]

Details see Product sheet water M2-05-03 part 1



Float switch monitoring pump house

Part no.: 842358 [Float switch]

Details see Product sheet water M2-05-03 part 4



Float switch for monitoring XP

Part no.: 850811 [Float switch XP]

Details see Product sheet water M2-65-07 part 1



Float switch monitoring 350L-XP

Part no.: 924115

Float switch for level control

Part no.: 879487

Details see Product sheet water M2-02-21 part 7



Float switch for liquid level indicator

Part no.: 898892

Details see Product sheet water M2-05-03 part 3





Monitoring and release devices

Water-based suppression systems - components

Limit switch for monitoring
FMZ-XP, M20x1.5

Part no.: 850760

Details see Product sheet water M2-65-03 part 1



Limit switch XP

Part no.: 848367

Details see Product sheet water M2-65-04 part 1



Temperature switch

Part no.: 901055

Details see Product sheet water M2-03-26 part 1



Switch monitoring OSYSU2a Potter

Part no.: 921196

Details see Product sheet water M2-02-08 part 6





Monitoring and release devices

Inert gas and Halocarbon agents

Thermo - switch STS-1



e.g. Part no.: 817194

Details see
Product sheet P21-211-440_001

Thermo - switch STS-Ex



e.g. Part no.: 886851

Details see
Product sheet P21-214-440_001

Sensor length	Release temperature	STS-1 Part no.	STS-Ex Part no.	Color code
100	57 °C (134,6 °F)	817194	886851	orange
	68 °C (154,4 °F)	817200	886852	red
	93 °C (199,4 °F)	817224	886853	green
	141 °C (285,8 °F)	817236	886854	blue
	182 °C (359,6 °F)	817248	886855	violet
	260 °C (500 °F)	817250	886856	black
200	57 °C (134,6 °F)	816335	886634	orange
	68 °C (154,4 °F)	811738	886635	red
	93 °C (199,4 °F)	816359	886636	green
	141 °C (285,8 °F)	816360	886637	blue
	182 °C (359,6 °F)	816372	886638	violet
	260 °C (500 °F)	816384	886639	black
350	57 °C (134,6 °F)	816396	886640	orange
	68 °C (154,4 °F)	816402	886641	red
	93 °C (199,4 °F)	816426	886643	green
	141 °C (285,8 °F)	816438	886644	blue
	182 °C (359,6 °F)	816440	886645	violet
	260 °C (500 °F)	816451	886646	black

Spare glass bulbs

Spare glass bulbs 5 mm, individually packed complete with enclosed test certificate according to EN 10204-2.2:

Release temperature	Part no.	Color code
57 °C (134,6 °F)	819877	orange
68 °C (154,4 °F)	819889	red
93 °C (199,4 °F)	819890	green
141 °C (285,8 °F)	819907	blue
182 °C (359,6 °F)	819919	violet
260 °C (500 °F)	819920	black



Monitoring and release devices

Inert gas and Halocarbon agents

Mounting socket for thermo switch STS-1

Part no.: 812664 [screw on]

Part no.: 812640 [plug in]

Details see product sheet P21-211-440_002





Monitoring and release devices Inert gas and Halocarbon agents

Light barrier for monitoring loss

Part no.: 876541

Details see
product sheet P21-214-430_004

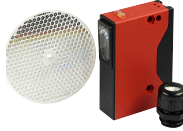

Limit switch system monitoring / I88-SU1Zw

Part no.: 763261

Details see
product sheet P21-214-430_008



Limit switch type UK 432y U=180

Part no.: 886616

Details see
product sheet P21-214-430_009



Limit switch monitoring CO2 LP selector valve

Part no.: 886345

Details see
product sheet P21-224-430_003





Monitoring and release devices Inert gas and Halocarbon agents

Limit switch ZS 256-11z



Part no.: 828482

Details see
product sheet P21-211-430_004

Limit switch type US 432y, 2 contacts



Part no.: 724420

Details see
product sheet P21-211-430_005

Limit switch type US 434y, 4 contacts



Part no.: 224831

Details see
product sheet P21-211-430_006

Limit switch EM 41 D 1Ö/1S



Part no.: 722990

Details see
product sheet P21-211-430_007



Monitoring and release devices

Inert gas and Halocarbon agents

Contact pressure gauge NC with plug QRV 200 bar and 300 bar

Details see
Product sheet P21-211-430_010



Nominal pressure at 15 °C (59 °F) bar (psi)	Part no.	Switching mode	Pressure range / switching point bar (psi)	Max. working pressure at 50 °C (122 °F) bar (psi)	Weight kg (lbs)
200 (2900)	917534	break contact (NC)	315 / 180 ±5 (4400 / 2611 ±73)	240 (3481)	0.16 (0.35)
300 (4350)	917535		400 / 270 ±7.5 (5800 / 2916 ±109)	360 (5221)	

Contact pressure gauge NC with plug 200 bar and 300 bar

Details see
Product sheet P21-211-430_002



Nominal pressure at 15 °C (59 °F) bar (psi)	Part no.	Switching mode	Pressure range / switching point bar (psi)	Max. working pressure at 50 °C (122 °F) bar (psi)	Weight kg (lbs)
200 (2900)	915039	break contact (NC)	315 / 180 ±5 (4400 / 2611 ±73)	240 (3481)	0.16 (0.35)
300 (4350)	915038		400 / 270 ±7.5 (5800 / 2916 ±109)	360 (5221)	



Monitoring and release devices

Inert gas and Halocarbon agents

Contact pressure gauge Ar / N₂

Details see
Product sheet P21-211-430_001



Nominal pressure at 20 °C (68 °F) bar (psi)	Part no.	Part no.	Pressure range / switching point bar (psi)	Max. working pressure at 50 °C (122 °F) bar (psi)	Weight kg (lbs)
200 (2901)	888613	break contact (NC)	315 / 180 (4569 / 2611)	240 (3481)	0.15 (0.33)
300 (4351)	888615		400 / 270 (5802 / 3916)	360 (5221)	0.14 (0.31)
200 (2901)	888617	make contact (NO)	315 / 180 (4569 / 2611)	240 (3481)	0.16 (0.35)
300 (4351)	888618		400 / 270 (5802 / 3916)	360 (5221)	0.16 (0.35)

Details see
Product sheet P21-231-430_001



Nominal pressure at 20 °C (68 °F) bar (psi)	Part no.	Switching mode	Pressure range / switching point bar (psi)	Max. working pressure at 50 °C (122 °F) bar (psi)	Weight kg (lbs)
25 (363)	888604	break contact (NC)	40 / 22.5 (580 / 326)	35 (508)	0.17 (0.37)
42 (609)	888606		60 / 38 (870 / 551)	53 (767)	0.16 (0.35)
50 (725)	888607		60 / 45 (870 / 653)	60 (870)	0.16 (0.35)
25 (363)	888608	make contact (NO)	40 / 22.5 (580 / 326)	35 (508)	0.17 (0.37)
42 (609)	888610		60 / 38 (870 / 551)	53 (767)	0.16 (0.35)
50 (725)	888611		60 / 45 (870 / 653)	60 (870)	0.17 (0.37)
Caution special type:					
Contact pressure gauge without VdS system approval for MX 200/1230 fire extinguishing system					
42 (609)	888605	break contact (NC)	60 / 36 (870 / 522)	53 (767)	0.16 (0.35)
	888605	make contact (NO)			0.17 (0.37)



Monitoring and release devices

Inert gas and Halocarbon agents

Details see
Product sheet P21-231-430_004



Nominal pressure at 21 °C (70 °F) psi (bar)	Switching mode	Part no.	Pressure range / switching point psi (bar)	Max. pressure psi (bar)	Weight kg (lbs)
360 (25)	break contact (NC)	889311	870 / 324 (60 / 22.5)	725 (50)	0.17 (0.37)
610 (42)		889312	1160 / 549 (80 / 37.8)	1015 (70)	
725 (50)		889313	1450 / 653 (100 / 45)	1160 (80)	
360 (25)	make contact (NO)	889306	870 / 324 (60 / 22.5)	725 (50)	
610 (42)		889307	1160 / 549 (80 / 37.8)	1015 (70)	
725 (50)		889309	1450 / 653 (100 / 45)	1160 (80)	

Details see
Product sheet P21-231-430_002



Nominal pressure at 21 °C (70 °C) psi (bar)	Switching mode	Part no.	Pressure range / switching point psi (bar)	Max. pressure psi (bar)	Weight kg (lbs)
360 (25)	break contact (NC)	889303	870 / 324 (60 / 22.5)	725 (50)	0.17 (0.37)
610 (42)		889304	1160 / 549 (80 / 37.8)	1015 (70)	
725 (50)		889305	1450 / 653 (100 / 45)	1160 (80)	
360 (25)	make contact (NO)	889300	870 / 324 (60 / 22.5)	725 (50)	
610 (42)		889301	1160 / 549 (80 / 37.8)	1015 (70)	
725 (50)		889302	1450 / 653 (100 / 45)	1160 (80)	



Monitoring and release devices

Inert gas and Halocarbon agents

Details see
Product sheet P21-231_430_005



Nominal pressure at 21 °C (70 °C)	Part no.	Pressure range	Max. pressure	Weight
psi (bar)		psi (bar)	psi (bar)	kg (lbs)
360 (25)	912100	870 (60)	725 (50)	0.15 (0.33)
610 (42)	912101	1160 (80)	1015 (70)	
725 (50)	912102	1450 (100)	1160 (80)	

Details see
Product sheet P21-231-430_003



Nominal pressure at 21 °C (70 °C)	Part no.	Pressure range	Max. pressure	Weight
psi (bar)		psi (bar)	psi (bar)	kg (lbs)
360 (25)	912097	870 (60)	725 (50)	0.15 (0.33)
610 (42)	912098	1160 (80)	1015 (70)	
725 (50)	912099	1450 (100)	1160 (80)	

Connection set contact pressure gauge

Part no.: 913930

Details see
Product sheet P21-211-430_003





Fire brigade accessories

Chapter 03



Fire brigade and system accessories

Fire brigade control panel FMZ 5000 mod S

Fire brigade control panel FBF 2003 serial mod S

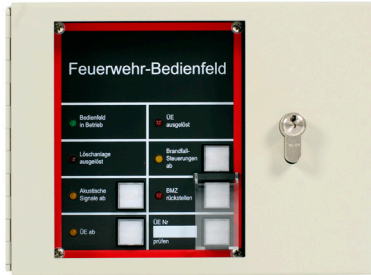

Technical specifications

Operating voltage	10 V - 42 V DC
Quiescent current consumption (24 V)	approx. 15 mA
Alarm current consumption (24 V)	approx. 30 mA
Operating temperature	0 °C to +50 °C (+32 °F to +122 °F)
IP rating	IP 30
Enclosure colour	RAL 7032
Weight	3.6 kg (7.9 lbs)
Dimensions	255 x 185 x 58 mm (WxHxD) 10 x 7.3 x 2.3 inch (WxHxD)

Part no.: 910530

Fire brigade control panel for FMZ 5000 mod S control panels in accordance with DIN 14661.

The front door can be locked with a case lock with profile half cylinder in accordance with DIN 18252

Connection / mounting

Connection takes place via the RS422 interface of the FMZ 5000 mod S card's fire alarm peripheral.

This card is not included in the basic version of the unit.

Included in delivery

Fire alarm control panel, completely ready for assembly to be connected to the fire alarm control unit.

Not included in delivery

Mounting hardware: screws and dowels
FMZ 5000 mod S fire accessory

909365

Approvals / marking



G 205053



Fire brigade accessories

Fire brigade control panel FMZ 5000

Fire brigade control panel FBF 2001

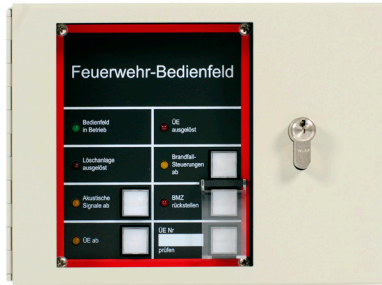

Technical specifications

Operating voltage	10 V - 30 V DC
Quiescent current consumption (24 V)	approx. 10 mA
Alarm current consumption (24 V)	approx. 75 mA
Operating temperature	0 °C to +50 °C (+32 °F to +122 °F)
IP rating	IP 30
Enclosure colour	RAL 7032
Weight	3.4 kg (7.5 lbs)
Dimensions	255 x 185 x 58 mm (WxHxD) 10 x 7.3 x 2.3 inch (WxHxD)

Part no.: 908147

Fire brigade control panel for FMZ 5000 control panels in accordance with DIN 14661. The front door can be locked with a case lock with profile half cylinder in accordance with DIN 18252.

Connection / mounting

The control panel is connected directly to the remote transmission unit module using a 20-pin ribbon cable. For this the ADP-FBF-MX connector card needs to be inserted in the FBF. Alternatively, for connection using cable wires, the FLK20 adapter (from Phoenix Contact) can be used in the fire alarm panel.

Included in delivery

Fire brigade control panel completely assembled and ready for connection to the fire alarm panel, including ADP-FBF-MX connector card.

Not included in delivery

Mounting hardware: screws and dowels
Ribbon connecting cable, round
Remote transmission unit module
Profile half cylinder

800315
901969

Approvals / marking

  G 299034



Fire brigade accessories

Fire brigade display panel FMZ 5000

Fire brigade display panel FAT 2002



Technical specifications

Operating voltage	10 V - 30 V DC
Quiescent current consumption (24 V)	approx. 21 mA
Alarm current consumption (24 V)	max. approx. 51 mA
Operating temperature	0 °C to + 50 °C (+32 °F to +122 °F)
IP rating	IP 30
Enclosure colour	RAL 7032
Weight	3.6 kg (7.9 lbs)
Dimensions	255 x 185 x 58 mm (WxHxD) 10 x 7.3 x 2.3 inch (WxHxD)

Part no.: 908148

Fire brigade display panel for FMZ 5000 control panels. Text display with 4 rows of 20 characters each. The text sent from the message frame is used, which is why no configuration is required. Two signals can be displayed at the same time.

Connection / mounting

Connection is established via the RS232 or RS422 interface on the SIO1 or SIO3 module. The Mx2 data protocol is used.

Included in delivery

Fire brigade display panel completely assembled and ready for connection to the fire alarm panel. Interface module with Minimax data protocol. Specify RS232 or RS422 interface when ordering.

Not included in delivery

Mounting hardware: screws and dowels
Connecting cable
Profile half cylinder

Approvals / marking



Fire brigade display panel FAT 2002 re



Part no.: 908149

Fire brigade display panel for FMZ 5000 control panels in accordance with DIN 14662 for indication of fire alarm and fault signals as initial information for the fire brigade. Text display with 4 rows of 20 characters each. The text sent from the message frame is used, which is why no configuration is required. Two signals can be displayed at the same time.

Connection / mounting

Connection is established via the RS232 interface on the SIO1 or SIO3 module, to an ADP-NB adapter card in the fire alarm panel. The FAT 2002 re is connected to the ADP-NB via 2 data lines. The Mx2 data protocol is used.

Approvals / marking





Fire brigade accessories

Fire brigade display panel FMZ 5000 mod S

FAT 3000 mod S



Technical specifications

Operating voltage	10 V - 42 V DC
Quiescent current consumption (24 V)	approx. 50 mA
Alarm current consumption (24 V)	approx. 80 mA
Operating temperature	0 °C to + 50 °C (+32 °F to +122 °F)
IP rating	IP 30
Enclosure colour	RAL 7032
Weight	3.6 kg (7.9 lbs)
Dimensions	255 x 185 x 58 mm (WxHxD) 10 x 7.3 x 2.3 inch (WxHxD)

Part no.: 910526

Fire brigade display panel for FMZ 5000 mod S control panels according to DIN 14662 to display fire alarm and fault messages as initial information for the fire brigade. Text display with 4 rows of 20 characters each. Two signals can be displayed at the same time.

Connection / mounting

The connection occurs via the RS422 interface of the card FMZ5000 mod S fire brigade peripheral equipment. This card is not included in the basic configuration of the fire detection control panel.

Included in delivery

Fire brigade display panel complete, ready for connection to the fire detection control panel.

Not included in delivery

Accessories FMZ 5000 mod S fire brigade 909365
Connection cable
Fastening material, screws and dowels

Approvals / marking



FAT 3000 mod S red



Part no.: 910529

Fire brigade display panel with redundant data connection to the control panel as initial information for the fire brigade.

Connection / mounting

The connection occurs via the RS422 interface of the card FMZ 5000 S fire brigade peripheral equipment. This card is not included in the basic configuration of the control panel. Provision of the redundant data interface requires installation of an ADP-N3E.U adapter board in the control panel.

Included in delivery

Fire brigade display panel complete, ready for connection to the fire detection control panel, including ADP-N3E-U adapter board.

Approvals / marking





Fire brigade accessories

Fire brigade display panel FMZ 5000

FAT 3000



Technical specification

Operating voltage	10 V - 42 V DC
Quiescent current consumption (24 V)	approx. 50 mA
Alarm current consumption (24 V)	approx. 80 mA
Operating temperature	0 °C to +50 °C +32 °F to +122 °F
IP rating	IP 30
Enclosure color	RAL 7032
Weight	3.6 kg (7.9 lbs)
Dimensions	255 x 185 x 58 mm (WxHxD) 10 x 7.3 x 2.3 inch (WxHxD)

Part no.: 926065

Fire brigade display panel for the fire alarm control panels FMZ 5000 in accord. with DIN 14662 and EN54-2 for indication of fire alarm and fault signals as initial information for the fire brigade. Text display with 4 rows of 20 characters each. The text sent from the message frame is used, which is why no configuration is required. Two signals can be displayed at the same time.

Connection / mounting

Connection is established via the RS232 or RS422 interface on the SIO1 or SIO3 module. Optionally, the FAT 3000 can be used for redundant connection to FMZ 5000 fire alarm control panels. The Mx2 data protocol is used.

Included in delivery

Fire brigade display panel completely assembled and ready for connection to the fire alarm panel.
Interface with data protocol.

Not included in delivery

Mounting hardware: screws and dowels
Connecting cable
Profile half cylinder

Approvals / marking





Fire brigade accessories

Fire brigade information and operating system

FIBS3000-K2-S1-RE



Technical specifications

Operating voltage	10 V - 30 V DC
Quiescent current consumption (24 V)	approx. 55 mA
Alarm current consumption (24 V)	approx. 95 mA
Operating temperature	0 °C to +50 °C (+32 °F to +122 °F)
IP rating	IP 30
Color	RAL 3000
Weight	4.8 kg (10.6 lbs)
Dimension	255 x 380 x 60 mm (WxHxD) 10.0 x 15.0 x 2.4 inch (WxHxD)

Part no.: 926067

Fire brigade information and operating system including serially connected fire brigade control panel and fire brigade display panel. On-wall or flush mounting.

Connection / mounting

The fire brigade information and operating system has to be used in combination with the control panel FMZ 5000 with module ADP-N3E, part no. 926066, and the module remote transmission unit, part no. 901969.

Included in delivery

Fire brigade display panel FAT3000, fire brigade control panel FBF3000, sheet steel enclosure with a case lock for a profile half-cylinder. Completely assembled and ready for installation in the fire detection panel FMZ 5000.

Note

If the installation of the fire brigade control panel is not in the immediate vicinity of the fire detection control panel in accordance with DIN 14661, the transmission routes have to be monitored. If the fire brigade display panel is used to provide the initial information to the fire brigade in accordance with DIN 14662 and EN 54-2, redundant transmission routes have to be used.

Approvals / marking



FIBS3000-K2-S1-RE-DKM



Technical specifications

Dimension	371 x 560 x 100 mm (WxHxD) 14.6 x 22.0 x 3.9 inch (WxHxD)
-----------	--

Part no.: 926068

The blind plate of the installation area functions in combination with the stud bolts as a mounting plate for the optionally used non-automatic or major detector, format DKM.

Otherwise like part no. 926067

Accessories

Cover FIBS-K2-DKM

926074

Approvals / marking





Fire brigade accessories

Fire brigade information and operating system

FIBS3000-A4-S2-RE



Technical specifications

Operating voltage	10 V - 30 V DC
Quiescent current consumption (24 V)	approx. 55 mA
Alarm current consumption (24 V)	approx. 95 mA
Operating temperature	0 °C to +50 °C (+32 °F to + 122 °F)
IP rating	IP 30
Color	RAL 3000
Weight	23 kg (50.7 lbs)
Dimension	710 x 560 x 100 mm (WxHxD) 28.0 x 22.1 x 3.9 inch (WxHxD)

Part no.: 926071

Fire brigade information and operating system including serially connected fire brigade control panel and fire brigade display panel. Including 2 shelves for storing 2x75 fire brigade route cards, format DIN A4. On-wall or flush mounting.

Connection / mounting

The fire brigade control panel has to be used in combination with the control panel FMZ 5000 with module ADP-N3E, part no. 926066, and the module remote transmission unit, part no. 901969.

Included in delivery

Fire brigade display panel FAT3000, fire brigade control panel FBF3000, sheet steel enclosure with a case lock for a profile half-cylinder. Completely assembled and ready for installation in the fire detection panel FMZ 5000.

Accessories

Frame for flush mounting.

Note

If the installation of the fire brigade control panel is not in the immediate vicinity of the fire detection control panel in accordance with DIN 14661, the transmission routes have to be monitored. If the fire brigade display panel is used to provide the initial information to the fire brigade in accordance with DIN 14662 and EN 54-2, redundant transmission routes have to be used.

Approvals / marking



G 205076
G 210045

FIBS3000-A3-S2-RE



Technical specifications

Weight	25 kg (55.1 lbs)
Dimension	830 x 560 x 100 mm (WxHxD) 32.7 x 22.0 x 3.9 inch (WxHxD)

Part no.: 926070

Including 1 shelf for storing 1x100 fire brigade route cards, format DIN A3.

Otherwise like part no. 926071

Approvals / marking



G 205076
G 210045



Fire brigade accessories

Fire brigade display panel FMZ 5000

Adapter ADP-N3E

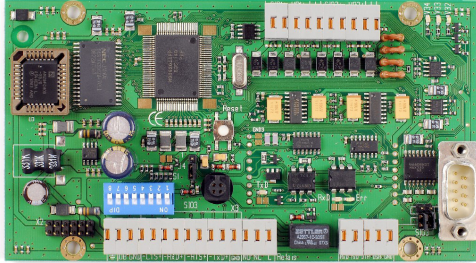

Product features

- Interface to the fire detection panel FMZ 5000, module SIO1
- Interface to the fire detection panel FMZ 5000, module SIO3
- Interface to the fire detection panel FMZ 5000, module transmission device
- Interface to the fire brigade display panel, redundant bus (data and voltage)

Technical specification

Operating voltage	10 V - 42 V DC
Quiescent current consumption (24 V)	approx. 45 mA
Alarm current consumption (24 V)	approx. 45 mA
Dimensions	80 x 150 x 30 mm (WxHxD) 3.2 x 5.9 x 1.2 inch (WxHxD)

Part no.: 926066

Adapter assembly for providing the redundant connection to the fire brigade display panel FAT 3000, part no. 926065 outgoing from the serial interface of the fire detection system. With the adapter ADP-N3E, the interface of the fire detection system can be used as a redundant transmission route in accordance with EN 54-2/DIN 14675, in case the fire brigade display panel (FAT) provides the initial information to the fire brigade. Prepared to take in the ADP-FBF if the FAT-protocol does not contain the information of the fire brigade control panel.

Connection / mounting

Mounting on DIN rail inside the panel FMZ 5000.
Via RS232 or RS422 Interface.

Included in delivery

Adapter ADP-N3, prepared for the connection to the module transmission device inside the control panel FMZ 5000.



Fire brigade accessories

Frames

Frame FIBS-A3



Part no.: 926072

Cover with powder coated surface for flush mounting of fire brigade information and operating systems. Format DIN A3.

Technical specifications

Installation dimension	850 x 580 x 90 mm (WxHxD) 33.5 x 22.8 x 3.5 inch (WxHxD)
External dimension	890 x 620 mm (WxH) 35.0 x 25.04 inch (WxH)
Material	Aluminum
Color	RAL 3000
Weight	2 kg 4.41 lbs

Frame FIBS-A4



Part no.: 926073

Cover with powder coated surface for flush mounting of fire brigade information and operating systems. Format DIN A4.

Technical specifications

Installation dimension	730 x 580 x 90 mm (WxHxD) 28.7 x 22.8 x 3.5 inch (WxHxD)
External dimension	770 x 620 mm (WxH) 30.1 x 24.4 inch (WxH)
Material	Aluminum
Color	RAL 3000
Weight	1.8 kg 3.97 lbs

Frame FIBS-K2-DKM

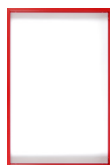

Part no.: 926074

Cover with powder coated surface for flush mounting of fire brigade information and operating systems. Format K2-DKM.

Technical specifications

Installation dimension	392 x 580 x 90 mm (WxHxD) 15.4 x 22.8 x 3.5 inch (WxHxD)
External dimension	432 x 620 mm (WxH) 17.0 x 24.4 inch (WxH)
Material	Aluminum
Color	RAL 3000
Weight	2.1 kg 4.6 lbs



Fire brigade and system accessories

Graphic panel

LMT-4 LED graphic panel

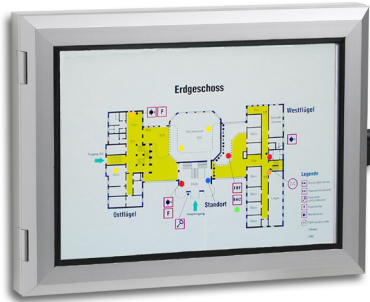

Product features

- For DIN A4 insert with lock
- extensive accessories and various interfaces and connection- and distribution boards with parallel or serial signal inputs

Technical specifications

Output voltage	24 V DC
Housing material	Aluminum
Protection class	IP 54
Weight	1850 g (4.1 lbs)
Dimensions	359 x 272 x 46 mm (WxHxD) 14.13 x 10.7 x 1.8 inch (WxHxD)

Part no.: 910169

LED graphic panel in an aluminum housing with hinged grid plate and transparent front window for a user-defined layout in between that can be replaced at any time, e.g. diagram, plot etc. The panel allows the placement of LEDs that light up the inserted plan at desired points, plus sensor buttons which trigger switch functions at any place in the plan by tapping through the front plate as on a touch panel.

Included in delivery

1 LMT-4 LED graphic panel without attachment material

Not included in delivery

Red LED diodes for LMT panel	910172
Green LED diodes for LMT panel	910173
Yellow LED diodes for LMT panel	910174
8 LED adapter card for LMT panel	910175
Capacitive button for LMT panel	910176
LED distribution board VK-16	910177

Approvals / marking



LMT-3 LED graphic panel

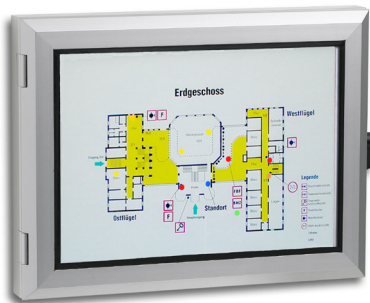

Product features

- For DIN A3 insert with lock
- Extensive accessories and various interfaces and connection- and distribution boards with parallel or serial signal inputs

Technical specifications

Output voltage	24 V DC
Housing material	Aluminum
Protection class	IP 54
Weight	3050 g (6.7 lbs)
Dimensions	482 x 359 x 46 mm (WxHxD) 19 x 14.1 x 1.8 inch (WxHxD)

Part no.: 910171

LED graphic panel in an aluminum housing with hinged grid plate and transparent front window for a user-defined layout in between that can be replaced at any time, e.g. diagram, plot etc. The panel allows the placement of LEDs that light up the inserted plan at desired points, plus sensor buttons which trigger switch functions at any place in the plan by tapping through the front plate as on a touch panel.

Included in delivery

1 LMT-3 LED graphic panel without attachment material

Not included in delivery

Red LED diodes for LMT panel	910172
Green LED diodes for LMT panel	910173
Yellow LED diodes for LMT panel	910174
8 LED adapter card for LMT panel	910175
Capacitive button for LMT panel	910176
LED distribution board VK-16	910177

Approvals / marking





Fire brigade and system accessories

Graphic panel

Red LED diodes for LMT panel



Part no.: 910172

Super bright LED prefabricated with flexible 800 mm connecting cable and reverse-polarity protected sockets for safe attachment to distributor-, adapter- or system-specific control modules.

Included in delivery

8 LM LED red
Plastic spacer

Technical specifications

Weight	45 g (0.1 lbs)
--------	----------------

Green LED diodes for LMT panel

Part no.: 910173

8 LM LED green

Otherwise as for part no. 910172

Yellow LED diodes for LMT panel

Part no.: 910174

8 LM LED yellow

Otherwise as for part no. 910172

8 LED adapter card for LMT panel



Part no.: 910175

Universal adapter board for 8 LEDs, with 8 pre-resistors.

Included in delivery

1 LED adapter card for LMT panel for 8 LEDs. Plastic spacers.

Technical specifications

Signal voltage	24 V DC
Signal current	10 mA
Weight	31 g (0.1 lbs)
Dimensions	113 x 37 x 15 mm (WxHxD) 4.5 x 1.5 x 0.6 inch (WxHxD)



Fire brigade and system accessories

Graphic panel

Capacitive button for LMT panel

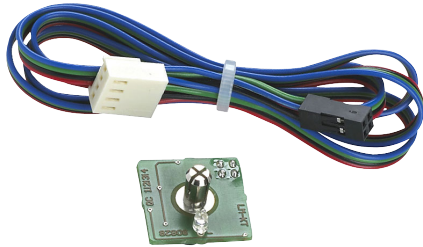

Part no.: 910176

Compact capacitive sensor button as control element for plugging into the 5 mm holes of the LM breadboard. When approached by a finger, it switches the optocoupler output through the front panel together with an optical status display. It performs self-calibration to suppress environmental influences.

Included in delivery

1 Capacitive button for LMT panel
Plastic spacer

LED distribution board VK-16

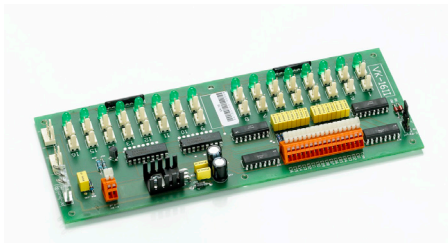

Part no.: 910177

LED distribution board for 16 signal inputs and 16 x 2 LED outputs on polarized pin connectors, with a slot for the connection of a lamp test button. Input signals either positive or negative through bidirectional optocoupler inputs.

Included in delivery

1 LED distribution board VK-16
Plastic spacer

Technical specifications

Operating voltage	12 V - 24 V DC
Quiescent current consumption	4 mA
Current consumption per activated output	10 mA
Max. current consumption	170 mA
Signal level optocoupler inputs	min. 5 V max. 24 V
Weight	107 g (0.24 lbs)
Dimensions	200 x 20 x 78 mm (WxHxD) 7.87 x 0.78 x 3.07 inch (WxHxD)



System accessories

Chapter 04



System accessories

Overvoltage protection - EMC

Installation areas (acc. to VdS 2833)

In accordance with the lightning protection zones concept of DIN EN 62305-4 (VDE 0185-305-4), any building and its vicinity is divided into installation areas with different risks of lightning strike or overvoltage. This classification is used to design the necessary protective measures.

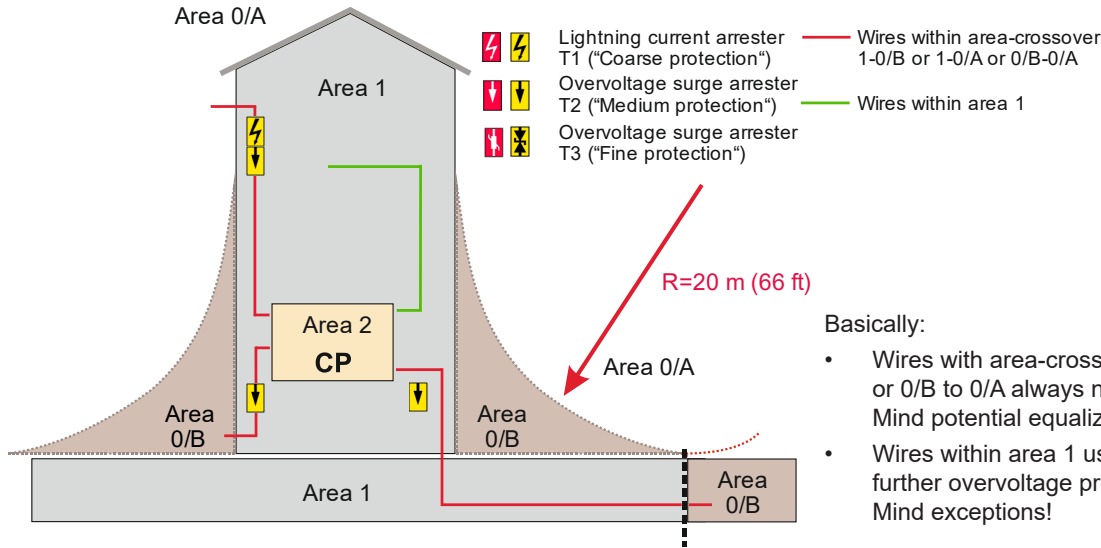

Basically:

- Wires with area-crossover 1 to 0/B, 1 to 0/A or 0/B to 0/A always need protective devices. Mind potential equalization !
- Wires within area 1 usually do not require further overvoltage protection. Mind exceptions!

Definition of Installation areas (acc. to VdS 2833)

Area 0/A Area where a direct lightning strike is likely and the electromagnetic field of lightning might have an undamped effect.

Area 0/B Area is protected from direct lightning strike by the building or air terminals, the electromagnetic field of lightning might have an undamped effect.

Area 1 Area within the building or beneath area 0/B, where no direct lightning strike is likely (depending on shield and lightning conductor devices), the electromagnetic field of lightning might have a damped effect.

Area 2 Area inside of devices, e.g. inner space of the control panel.

Note In systems with an individual lightning protection zone concept, additionally to the installation areas according to VdS 2833, further protection areas according to IEC/EN Standard may be defined.

Selecting the suitable protection devices, there is a basic differentiation between protection devices used for energy technology and information technology systems (see next page „Lightning and overvoltage protection - devices“).

These two systems are separated into lightning current, combi and overvoltage protection devices. Lightning current and combi protection devices protect the area-crossover 0/A to 1 and 0/A to 2. They prevent the inflow of destroying lightning currents into the control panel inside the building by discharging the energy to the potential equalization.

Following the lightning current protection device, at the area-crossover 0/B to 1 or 1 to 2, overvoltage surge arresters reduce the energy once more.

Beside the overvoltage protection for energy technology and information technology systems, a complete lightning protection system maintains the outer lightning protection (lightning conductor, arrester, earthing), the potential equalization and the shielding.





System accessories

Overvoltage protection - EMC

Lightning and overvoltage protection devices

Information technology

Symbol (non normative) T1 T2 T3	Protection devices for extra low voltage (signaling & control circuits) / alternating current (AC) ≤ 50 V, direct current (DC) ≤ 120 V		Required surge current capability acc. to VdS 2833	Integrated decoupling	Min. cross-section of equipotential bonding conductor (collective drain conductor)
	D1 Coarse	Lightning current arrester: Area-crossover 0/A → 0/B Protecting of installations and devices from direct or nearby lightning strikes and full lightning electromagnetic field	Min. 2,5 kA per conductor (10µs/350µs)	No! Conductor length to next device min. 15 m / 45 ft	6 mm ² Cu
	C2 Medium	Overvoltage surge arrester Area-cross over 0/B → 1 Protection of installation and devices from overvoltages from remote lightning strikes with partial lightning currents or from the undamped lightning electromagnetic field	Min. 2,5 kA per conductor (8µs/20µs)	No! Conductor length to next device min. 5 m / 15 ft	4 mm ² Cu
	D1-C2 Coarse- Medium	Combi-arrester: Area-crossover 0/A → 1 Lightning current arrester with integrated overvoltage protection device	Min. 2,5 kA per conductor (10µs/350µs)	No! Conductor length to next device min. 5 m / 15 ft	6 mm ² Cu (4 mm ² , if only used for medium protection)
	D1-C2-C1 Coarse- Medium- Fine combi	Combi-arrester: Area-crossover 0/A → 2 Lightning current protection device including overvoltage protection and fine protection	Min. 2,5 kA per conductor (10µs/350µs)	Yes! No cable spacing to next device required	6 mm ² Cu, (4 mm ² , if only used for medium protection)
	C2-C1 Medium- Fine Combi	Combi-arrester: Area-crossover 0/B → 2 Protection of installations and end devices from category C2 (medium) overvoltages and -currents and additional fine protection	Min. 2,5 kA per conductor (8µs/20µs)		4 mm ² Cu
	C2-C1 Medium- Fine Combi	Ex-Combi-arrester: Area-crossover 0/B → 2 Protection of installations and end devices from category C2 (medium) overvoltages and -currents and additional fine protection	Min. 2,5 kA per conductor (8µs/20µs)		4 mm ² Cu

Energy technology

Symbol (non normative) T1 T2 T3	Protection devices for low-voltage (mains supply) / alternating current (AC) < 1050 V, direct current (DC) < 1500 V		Required surge current capability acc. to VdS 2833	Integrated decoupling	Min. cross-section of equipotential bonding conductor (1 x per rail)						
	Type 1 Coarse	Lightning current arrester: Area-crossover 0/A → 0/B Protection of installations and devices from direct or nearby lightning strikes and full lightning electromagnetic field	<table border="1"> <tr> <td>AC circuits 1-phase</td> <td>Min. 15 kA per conductor (10µs/350µs)</td> </tr> <tr> <td>AC circuits 3-phases</td> <td>Min. 12,5 kA per conductor (10µs/350µs)</td> </tr> <tr> <td>TT-power system: 3-phase circuits</td> <td>Min. 50 kA (10µs/350µs)</td> </tr> </table>	AC circuits 1-phase	Min. 15 kA per conductor (10µs/350µs)	AC circuits 3-phases	Min. 12,5 kA per conductor (10µs/350µs)	TT-power system: 3-phase circuits	Min. 50 kA (10µs/350µs)	No! Conductor length to next device min. 15 m / 45 ft	90 mm ² Cu Connecting to the main switching bar Conductor length not more than 0,5-1 m (1,5-3 ft) (VDE 0100-638)
AC circuits 1-phase	Min. 15 kA per conductor (10µs/350µs)										
AC circuits 3-phases	Min. 12,5 kA per conductor (10µs/350µs)										
TT-power system: 3-phase circuits	Min. 50 kA (10µs/350µs)										
	Type 2 Medium	Overvoltage surge arrester: Area-crossover 0/B → 1 Protection of installation and devices from overvoltages from remote lightning strikes with partial lightning currents or from the undamped lightning electromagnetic field	Min. 15 kA conductor (8µs/20µs)	No! Conductor length to next device min. 5 m / 15 ft	6 mm ² Cu Connecting to equipotential bonding rail is sufficient						
	Type 3 Fine	Overvoltage surge arrester: Area-crossover 1 → 2 Protection of installation and devices from overvoltages of already limited impulses of lightning strikes, from power switching impulses and electrostatic discharges	1-5 kA (partial voltage is decisive)	No!	1-4 mm ² Cu (not of the main supply) Connecting to mains supply PSE is sufficient, local potential equalization is to be preferred						
	Type 1+2 Combi	Combi-arrester: Area-crossover 0/A → 1 Lightning current arrester with integrated overvoltage protection device	see type 1	No! Conductor length to next device min. 5 m / 15 ft	see type 1						

303-010_001 / A/00_2016de
The contents of this publication are subject to modifications without notice. All rights reserved.
2/2



System accessories

Overvoltage protection - EMC

Overvoltage protection - operation with fire detection and suppression control panel FMZ 5000

Surge arrester Allocation table interfaces Information technology System FMZ 5000		Loop AP/AP XP module (redundant)	Control group module / Impulse valve reset module	Conventional detector module	8 relay module 24 V external	Remote transmission unit module	WEB module	SIO 1 - SIO 3 - / Modbus module / RS422/485	MxNET module	Reflex module				Spark test 8 module	Analog input 4-20 mA / +/- 10 V (PLC-interface)
Overvoltage protection Part no. / designation	Area- crossover	Coarse- Medium- Fine T1 T2 T3	X1 - X4	X1 - X4	X1 - X4	Residual voltage is decisive	X1 X2 (UE) X3 X4 (FSD)	Ethernet RJ45	COM1 COM2 / COM 3	X1 / X4	Alarm lines (X9- X10- X11- X12- .1/2) Spark detector without fault line (X1- X4- .1/2)	Spark detector with fault line (X1- X2- X4- / X3- .1/2)	Control output (X5- X8- .1/2)	Relay contact St. Gr. (X6- X7- .1/2)	Spark test detectors FTX (X1 -> X8- .1/2)
922789 Plug-in SPD block DRL 10 B 180 FSD	0/A - 1		X		X	X					X	X		X	X
922790 Overvoltage protection plug DRL RD 48	1 - 2		X		X	X					X	X		X	X
922847 BXT ML4 B 180	0/A - 1			X		X	X							X	X
922848 BXT ML4 BD 48	0/A - 2		X		X	X					X			X	X
922849 BXT ML4 BC 24	0/A - 2						X	X				X			
922850 BXTML4 BD HF 5	0/A - 2								X	X					
922841 BXT ML2 BD HFS 5	0/A - 2								X						
922839 BXT ML2 BD S 24	0/A - 2							X							
922840 BXT ML2 BD S 48	0/A - 2		X		X	X					X			X	X
922855 BXT ML4 MY 110	0/B - 1			X			X						X		X
922842 BXTML2 MY E 110	0/B - 1			X									X		
922861 BSP M4 BD 48	0/B - 2		X		X	X					X			X	X
922821 BVT ALD 36	0/A - 2			X		X							X	X	
922820 BVT RS485 5	0/B - 2								X	X					
922860 USD 25 V24 HS S B	0/B - 2								X						
922862 DPA M CAT6 RJ45S	0/B - 2							X							
922863 DPA M CLE RK45B 48	0/B - 2							X							
922854 BXT M2 BD S EX 24	0/B - 2		X		X	X					X	X		X	X
922859 BXT ML2 BD HF EX 6	0/B - 2								X	X					

1-303-010_002 / A/00_2016de
The contents of this publication are subject to modifications without notice. All rights reserved.





System accessories

Overvoltage protection - EMC, Information technology

Plug-in SPD block DRL 10 B 180 FSD

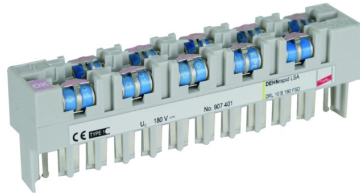

Product features

- Visual fault indicator of the gas discharge tubes
- Expandable to a combined lightning current and surge arrester
- For installation in conformity with the lightning protection zone concept at the interfaces from O_A-1 and higher

Technical specifications



Battery capacity	2.2 Ah
Arrester class	coarse and medium protection
Rated voltage	180 V
Max. continuous operating voltage	180 V DC
Rated current	0.4 A
D1 Lightning impulse current (10/350 μ s) per line	2.5 kA
C2 Nominal discharge current (8/20 μ s) per line	5 kA
Series resistance per line	$\leq 0.005 \Omega$
Capacitance line-line (C)	≤ 5 pF
Operating temperature	-40 °C to +80 °C (-40 °F to +176 °F)
IP rating	IP 10
Material	Polyamide PA 6.6, grey
Weight	approx. 69 g (0.15 lbs)
Dimensions	113 x 36 x 22 mm (WxHxD) 4.5 x 1.4 x 0.9 inch (WxHxD)

Approvals / marking



Part no.: 922789

Lightning current carrying DRL plug-in SPD block (10 pairs) for almost all applications. Expandable to a combined lightning current and surge arrester with the protective plug DRL RD 48, part no. 922790.

The integrated disconnection block contacts allow testing, measuring and patching with plugged-in protection.

The three-pole gas discharge tubes have a fail-safe function with visual fault indicator.

Included in delivery

Lightning current arrester for use as plug-in SPD block with integrated LSA-disconnection block function.

Optional accessories

Earthing frame EF 10 DRL	922793
Overvoltage protection plug DRL RD 48	922790

Spare parts

Gas discharge tube GDT 230 B3 FSD	922788
-----------------------------------	--------

Note

Insertable in disconnection block TL2 10DA LSA 922798
Keep decoupling distance from the fire alarm control panel of at least 5 m cable length.

Connection diagram

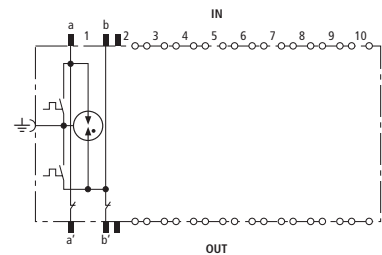



System accessories

Overvoltage protection - EMC, Information technology

Overvoltage protection plug DRL RD 48



Product features

- Low voltage protection level line/line for protecting terminal equipment
- Energy-coordinated with DRL plug-in block
- For installation in conformity with the lightning protection zone concept at the interfaces from 1-2 and higher

Technical specifications



Interface according to lightning protection zone concept	fine protection
Rated voltage	48 V
Max. continuous operating voltage	54 V
Rated current	0,4 A
D1 Lightning impulse current (10/350 µs) per line in combination with plug in block DRL 10 B 180 FSB	2.5 kA
C2 Nominal discharge current (8/20 µs) per line in combination with plug in block DRL 10 B 180 FSB	5 kA
C1 Nominal discharge current (8/20 µs) per line without plug in block DRL 10 B 180 FSB	0.25 kA
Series resistance per line	4.7 Ω
Capacitance line-line	≤ 700 pF
Operating temperature	-40 °C to + 80 °C (-40 °F to +176 °F)
IP rating	IP 20 (plugged)
Material	Polyamide PA 6.6, yellow
Weight	approx. 4 g (0.01 lbs)
Dimensions	9.4 x 22 x 33.4 mm (WxHxD)
	0.4 x 0.9 x 1.3 inch (WxHxD)

Part no.: 922790

Protective plug, energy-coordinated with DRL plug-in SPD DRL 10 B 180 FSD (part no.: 922789) for use as single-stage protective device for terminal equipment. Low voltage protection level line-line for floating interfaces.

Included in delivery

Overvoltage protection plug DRL RD 48

Not included in delivery

Earthing frame EF 10 DRL 922793
Plug-in SPD block DRL 10 B 180 FSK 922789

Note

In combination with the DRL plug-in SPD block DRL 10 B 180 FSD.



Approvals / marking





System accessories

Overvoltage protection - EMC, Information technology

Overvoltage protection BXT ML4 B 180



Product features

- LifeCheck® SPD monitoring function
- Four-pole lightning equipotential bonding
- For installation in conformity with the lightning protection zone concept at the interfaces from $O_A - 1$ and higher

Technical specifications



Arrester class	Coarse and medium protection
Monitoring system	LifeCheck®
Rated current DC	180 V
Max. continuous operating voltage DC	180 V
Max. continuous operating voltage AC	127 V
Rated current at 45 °C/113 °F	1.2 A
D1 Lightning impulse current (10/350 µs) per line	2.5 kA
C2 Nominal discharge current (8/20 µs) per line	10 kA
Series resistance per line	0.4 Ω
Capacitance line-line	≤ 16 pF
Capacitance line-PG	≤ 16 pF
Operating temperature	-40 °C to +80 °C (-40 °F to 176 °F)
IP rating	IP 20
Test method	IEC 61643-21 / EN 61643-21, UL 497B
Material	Polyamide PA 6.6, yellow
Weight	25 g (0.06 lbs)
Dimensions	12 x 45 x 51 mm (WxHxD) 0.5 x 1.8 x 2 inch(WxHxD)

Part no.: 922847

Space-saving four-pole lightning current arrester module with LifeCheck® feature for almost all types of applications. If LifeCheck® detects thermal or electrical overload, the arrester has to be replaced.

This status is indicated without contact by DRC SCM XT / DRC MCM XT or test device DRC LC M3.

Not included in delivery

Overvoltage protection base BXT BAS 922843

Optional accessories

Module condition monitoring DRC MCM XT 922804
Module condition monitoring DRC SCM XT 922805

Note

Insertable in and earthing via Base BXT BAS.

Keep decoupling distance to fire control panel of at least 5 m cable length.

Circuit diagram

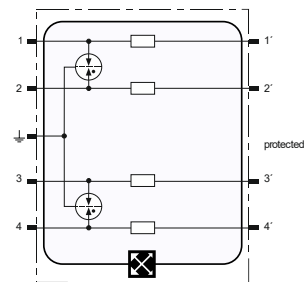

Approvals / marking

Type examination certificate:
IECEx conformity:

DEKRA 11ATEX0089 X
IECEx DEK 11.0032X





System accessories

Overvoltage protection - EMC, Information technology

Overvoltage protection BXT ML4 BD 48



Product features

- LifeCheck® monitoring function
- Optimal protection of two pairs
- For installation in conformity with the lightning protection zone concept at the interfaces from 0_A – 2 and higher

Technical specifications



Arrester class	Coarse, medium and fine protection
Monitoring system	LifeCheck®
Rated voltage DC	48 V
Max. continuous operating voltage DC	54 V
Max. continuous operating voltage AC	38.1 V
Rated current at 45 °C/113 °F	1.0 A
D1 Lightning impulse current (10/350 µs) per line	2.5 kA
C2 Nominal discharge current (8/20 µs) per line	10 kA
Series resistance per line	1.0 Ω
Capacitance line-line	≤ 0.7 nF
Capacitance line-PG	≤ 16 pF
Operating temperature	-40 °C tp +80 °C (-40 °F to 176 °F)
IP rating	IP 20
Test method	IEC 61643-21 / EN 61643-21, UL 497B
Material	Polyamide PA 6.6, yellow
Weight	24 g (0.05 lbs)
Dimensions	12 x 45 x 51 mm (WxHxD) 0.5 x 1.8 x 2 inch (WxHxD)

Part no.: 922848

Space-saving combined lightning current and surge arrester module with LifeCheck® feature for protecting two pairs of unearthed balanced interfaces.

If LifeCheck® detects thermal or electrical overload, the arrester has to be replaced.

This status is indicated without contact by DRC SCM XT / DRC MCM XT or test device DRC LC M3.

Not included in delivery

Overvoltage protection - Base BXT BAS 922843

Optional accessories

Module condition monitoring DRC MCM XT 922804
Module condition monitoring DRC SCM XT 922805

Note

Insertable in and earthing via Base BXT BAS.

Circuit diagram

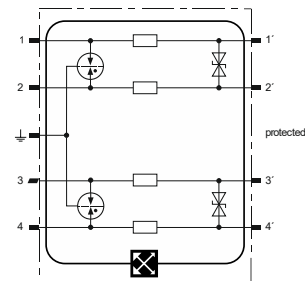

Approvals / marking

Ex-conformity acc. with 2014/34/EU: Ⓜ II 3 G Ex nA IIC T4 Gc
Type examination certificate: DEKRA 11ATEX0089 X
IECEx conformity: IECEx DEK 11.0032X





System accessories

Overvoltage protection - EMC, Information technology

Overvoltage protection BXT ML4 BC 24



Product features

- LifeCheck monitoring function
- Optimal protection of four lines
- For installation in conformity with the lightning protection zone concept at the interfaces from 0_A – 2 and higher

Technical specifications



Arrestor class	Coarse, medium and fine protection
Monitoring system	LifeCheck
Rated voltage DC	24 V
Max. continuous operating voltage DC	33 V
Max. continuous operating voltage AC	23.3 V
Rated current at 45 °C/113 °F	0.75 A
D1 Lightning impulse current (10/350 µs) per line	2.5 kA
C2 Nominal discharge current (8/20 µs) per line	10 kA
Series resistance per line	1.8 Ω
Capacitance line-line	≤ 1.0 nF
Capacitance line-PG	≤ 16 pF
Operating temperature	-40 °C to +80 °C (140 °F to 176 °F)
IP rating	IP 20
Test method	IEC 61643-21 / EN 61643-21, UL 497B
Material	Polyamide PA 6.6, yellow
Weight	24 g (0.05 lbs)
Dimensions	12 x 45 x 51 mm (WxHxD) 0.5 x 1.8 x 2 inch (WxHxD).

Part no.: 922849

Space-saving combined lightning current and surge arrester module with LifeCheck feature for protecting max. four unearthed single lines with common reference potential.

If LifeCheck detects thermal or electrical overload, the arrester has to be replaced.

This status is indicated without contact by DRC SCM XT / DRC MCM XT or test device DRC LC M3.

Not included in delivery

Overvoltage protection - Base BXT BAS 922843

Optional accessories

Module condition monitoring DRC MCM XT 922804
Module condition monitoring DRC SCM XT 922805

Note

Insertable in and earthing via Base BXT BAS.

Circuit diagram

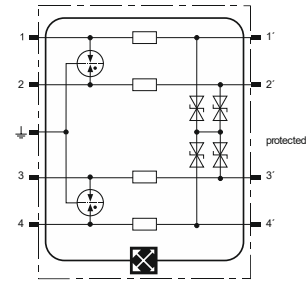

Approvals / marking

Ex-conformity acc. with 2014/34/EU: Ⓢ II 3 G Ex nA IIC T4 Gc
Type examination certificate: DEKRA 11ATEX0089 X
IECEx conformity: IECEx DEK 11.0032X





System accessories

Overvoltage protection - EMC, Information technology

Overvoltage protection BXT ML4 BD HF 5



Product features

- LifeCheck® monitoring function
- Optimal protection of two pairs
- For installation in conformity with the lightning protection zone concept at the interfaces from $O_A - 2$ and higher

Technical specifications



Arrester class	Coarse, medium and fine protection
Monitoring system	LifeCheck®
Rated voltage DC	5 V
Max. continuous operating voltage DC	6 V
Max. continuous operating voltage DC	4.2 V
Rated current at 45 °C/113 °F	1.0 A
D1 Lightning impulse current (10/350 µs) per line	2.5 kA
C2 Nominal discharge current (8/20 µs) per line	10 kA
Voltage protection level line-line for I_{imp} D1 (U_p)	≤ 25 V
Voltage protection level line-PG for I_{imp} D1 (U_p)	≤ 550 V
Series resistance per line	1.0 Ω
Capacitance line-line	≤ 25 pF
Capacitance line-IPG	≤ 16 pF
Operating temperature	-40 °C to +80 °C (-40 °F to +176 °F)
IP rating	IP 20
Test method	IEC 61643-21 / EN 61643-21, UL 497B
Material	Polyamide PA 6.6, yellow
Weight	24 g (0.05 lbs)

Part no.: 922850

Space-saving combined lightning current and surge arrester module with LifeCheck® feature for protecting two pairs of unearthed balanced interfaces.

If LifeCheck® detects thermal or electrical overload, the arrester has to be replaced.

This status is indicated without contact by DRC SCM XT / DRC MCM XT or test device DRC LC M3.

Not included in delivery

Overvoltage protection - Base BXT BAS 922843

Optional accessories

Module condition monitoring DRC MCM XT 922804
Module condition monitoring DRC SCM XT 922805

Note

Insertable in and earthing via Base BXT BAS.

Circuit diagram

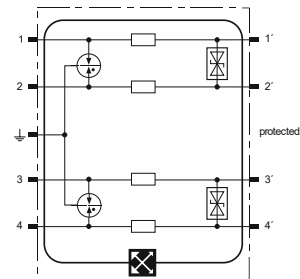

Approvals / marking

Ex conformity acc. with 2014/34/EU: Ⓜ II 3 G Ex nA IIC T4 Gc
Type examination certificate: DEKRA 11ATEX0089 X
IECEx conformity: IECEx DEK 11.0032X





System accessories

Overvoltage protection - EMC, Information technology

Overvoltage protection BXT ML2 BD HFS 5



Product features

- LifeCheck® monitoring function
- Minimal signal interference
- For installation in conformity with the lightning protection zone concept at the interfaces from 0_A – 2 and higher

Technical specifications



Arrester class	Coarse, medium and fine protection
Monitoring system	LifeCheck®
Rated voltage DC	5 V
Max. continuous operating voltage DC	6 V
Max. continuous operating voltage AC	4.2 V
Rated current at 45 °C/113 °F	1.0 A
D1 Lightning impulse current (10/350 µs) per line	2.5 kA
C2 Nominal discharge current (8/20 µs) per line	10 kA
Voltage protection level line-line for I _{imp} D1 (U _p)	≤ 25 V
Voltage protection level line-line at 1 kV/µs C3 (U _p)	≤ 11 V
Series resistance per line	1.0 Ω
Capacitance line-line	≤ 25 pF
Capacitance line-PG	≤ 25 pF
Operating temperatur	-40 °C to +80 °C (-40 °F to +176 °F)
IP rating	IP 20
Test method	IEC 61643-21 / EN 61643-21, UL 497B
Material	Polyamide PA 6.6, yellow
Weight	22 g (0.05 lbs)
Dimensions	12 x 45 x 51 mm (WxHxD) 0.5 x 1.8 x 2 inch (WxHxD)

Part no.: 922841

Space-saving combined lightning current and surge arrester module with LifeCheck® feature for protecting one pair of unearthed high frequency bus system or video transmission system, with direct or indirect shield earthing.

If LifeCheck® detects thermal or electrical overload, the arrester has to be replaced.

This status is indicated without contact by DRC SCM XT / DRC MCM XT or test device DRC LC M3.

Not included in delivery

Overvoltage protection - Base BXT BAS 922843

Optional accessories

Terminal - shield contact SAK BXT LRX 922856
Module condition monitoring DRC MCM XT 922804
Module condition monitoring DRC SCM XT 922805

Note

Insertable in and earthing via Base BXT BAS.

Circuit diagram

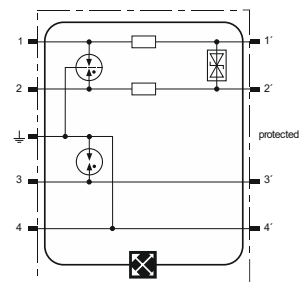

Approvals / marking

Ex conformity acc. with 2014/34/EU: Ⓜ II 3 G Ex nA IIC T4 Gc
Type examination certificate: DEKRA 11ATEX0089 X
IECEx conformity: IECEx DEK 11.0032X





System accessories

Overvoltage protection - EMC, Information technology

Overvoltage protection BXT ML2 BD S 24

Part no.: 922839

Space-saving combined lightning current and surge arrester module with LifeCheck® feature for protecting one pair of unearthed balanced interfaces, with direct or indirect shield earthing.

If LifeCheck® detects thermal or electrical overload, the arrester has to be replaced.

This status is indicated without contact by DRC SCM XT / DRC MCM XT or test device DRC LC M3.

Product features

- LifeCheck® monitoring function
- Optimal protection of one pair and the cable shield
- For installation in conformity with the lightning protection zone concept at the interfaces from $O_A - 2$ and higher

Not included in delivery

Overvoltage protection - Base BXT BAS 922843

Optional accessories

Module condition monitoring DRC MCM XT 922804

Module condition monitoring DRC SCM XT 922805

Technical specifications



Arrester class	Coarse-, medium and fine protection
Monitoring system	LifeCheck®
Rated voltage DC	24 V
Max. continuous operating voltage DC	33 V
Max. continuous operating voltage AC	23.3
Rated current at 45 °C/113 °F	1.0 A
D1 Lightning impulse current (10/350 µs) per line	2.5 kA
C2 Nominal discharge current (8/20 µs) per line	10 kA
Series resistance per line	1.0 Ω
Capacitance line-line	≤ 1.0 nF
Capacitance line-PG	≤ 25 pF
Operating temperature	-40 °C to +80 °C (-40 °F to +176 °F)
IP rating	IP 20
Test method	IEC 61643-21 / EN 61643-21
Material	Polyamide PA 6.6, yellow
Weight	21 g (0.05 lbs)
Dimensions	12 x 45 x 51 mm (WxHxD) 0.5 x 1.8 x 2 inch (WxHxD)

Note

Insertable in and earthing via Base BXT BAS.

Circuit diagram

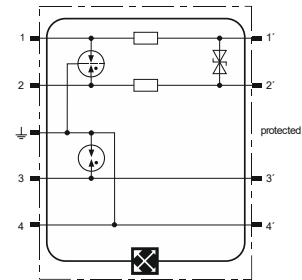

Approvals / marking

Ex conformity acc. with 2014/34/EU: Ⓜ II 3 G Ex nA IIC T4 Gc
 Type examination certificate: DEKRA 11ATEX0089 X
 IECEx conformity: IECEx DEK 11.0032X





System accessories

Overvoltage protection - EMC, Information technology

Overvoltage protection BXT ML2 BD S 48



Product features

- LifeCheck® monitoring function
- Optimal protection of one pair and the cable shield
- For installation in conformity with the lightning protection zone concept at the interfaces from 0_A – 2 and higher

Technical specifications



Arrestor class	Coarse, medium and fine protection
Monitoring system	LifeCheck®
Rated voltage DC	48 V
Max. continuous operating voltage DC	54 V
Max. continuous operating voltage AC	38.1 V
Rated current at 45 °C/113 °F	1.0 A
D1 Lightning impulse current (10/350 µs) per line	2.5 kA
C2 Nominal discharge current (8/20 µs) per line	10 kA
Series resistance per line	1.0 Ω
Capacitance line-line	≤ 0.7 nF
Capacitance line-PG	≤ 25 pF
Operating temperature	-40 °C to +80 °C (-40 °F to +176 °F)
IP rating	IP 20
Test method	IEC 61643-21 / EN 61643-21
Material	Polyamide PA 6.6, yellow
Weight	36 g (0.08 lbs)
Dimensions	12 x 45 x 51 mm (WxHxD) 0.5 x 1.8 x 2 inch (WxHxD)

Part no.: 922840

Space-saving combined lightning current and surge arrester module with LifeCheck® feature for protecting one pair of unearthed balanced interfaces, with direct or indirect shield earthing.

If LifeCheck® detects thermal or electrical overload, the arrester has to be replaced.

This status is indicated without contact by DRC SCM XT / DRC MCM XT or test device DRC LC M3.

Not included in delivery

Overvoltage protection - Base BXT BAS 922843

Optional accessories

Terminal - shield contact SAK BXT 922856
 Module condition monitoring DRC MCM XT 922804
 Module condition monitoring DRC SCM XT 922805

Note

Insertable in and earthing via Base BXT BAS

Circuit diagram

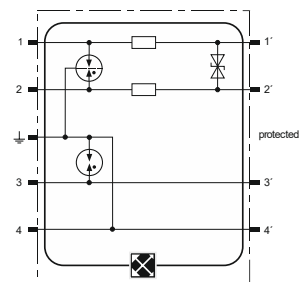

Approvals / marking

Ex conformity acc. with 214/34/EU: II 3 G Ex nA IIC T4 Gc
 Type examination certificate: DEKRA 11ATEX0089 X
 IECEx conformity: IECEx DEK 11.0032X

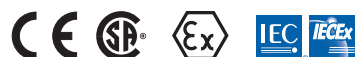



System accessories

Overvoltage protection - EMC, Information technology

Overvoltage protection BXT ML4 MY 110



Product features

- LifeCheck® monitoring function
- Fault-proof Y circuit
- For installation in conformity with the lightning protection zone concept at the interfaces O_B-1 and higher

Technical specifications



Arrester class	Medium protection
Monitoring system	LifeCheck®
Rated voltage DC	110 V
Max. continuous operating voltage DC line-line	170 V
Max. continuous operating voltage DC line-PG	85 V
Max. continuous operating voltage AC line-line	120 V
Max. continuous operating voltage AC line-PG	60 V
Rated voltage at 80 °C/176 °F	3.0 A
C2 Nominal discharge current (8/20 μ s) per line	2.5 kA
C2 Nominal discharge current (8/20 μ s) total (In)	10 kA
Capacitance line-line	≤ 1.5 nF
Capacitance line-PG	≤ 16 pF
Operating temperature	-40 °C to +80 °C (-40 °F to +176 °F)
IP rating (plugged in)	IP 20
Test method	IEC 61643-21 / EN 61643-21
Material	Polyamide PA 6.6, yellow
Weight	28 g (0.06 lbs)
Dimensions	12 x 45 x 51 mm (WxHxD) 0.5 x 1.8 x 2 inch (WxHxD)

Part no.: 922855

Space-saving surge arrester module with LifeCheck® feature for protecting four lines of stranded signal interfaces.

If LifeCheck® detects thermal or electrical overload, the arrester has to be replaced.

This status is indicated without contact by DRC SCM XT / DRC MCM XT or test device DRC LC M3.

Not included in delivery

Overvoltage protection - Base BXT BAS 922843

Optional accessories

Module condition monitoring DRC MCM XT 922804
Module condition monitoring DRC SCM XT 922805

Note

Insertable in and earthing via Base BXT BAS.

Keep decoupling distance from the fire control panel of at least 5 m cable length.

Circuit diagram

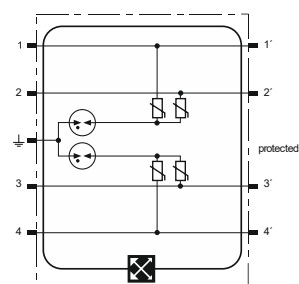

Approvals / marking





System accessories

Overvoltage protection - EMC, Information technology

Overvoltage protection BXT ML2 MY E 110

Part no.: 922842

Technical specification



C2 Nominal discharge current (8/20 μ s) total (In)	5 kA
Capacitance line-PG	≤ 25 pF
Weight	25 g (0.06 lbs)
Dimensions	12 x 45 x 51 mm (WxHxD)

Space-saving surge arrester module with LifeCheck® feature for protecting 2 pairs of lines of stranded signal interfaces.

Otherwise like part no.: 922855

Circuit diagram

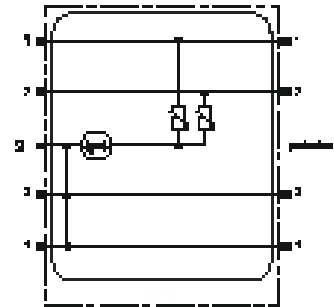



System accessories

Overvoltage protection - EMC, Information technology

Overvoltage protection BSP M4 BD 48

Part no.: 922861

Space-saving surge arrester module for protecting two pairs of balanced interfaces with galvanic isolation.



Product features

- High degree of protection for two pairs
- For installation in conformity with the lightning protection zone concept at the interfaces from $O_B - 2$ and higher.

Technical specifications



Arrester class	Medium and fine protection
Rated voltage DC	48 V
Max. continuous operating voltage DC	54 V
Max. continuous operating voltage AC	38.1 V
Rated current at 45 °C/113 °F	1.0 A
D1 Lightning impulse current (10/350 µs) per line	1.0 kA
C2 Nominal discharge current (8/20 µs) per line	10 kA
Series resistance per line	1.0 Ω
Capacitance line-line	≤ 0.7 nF
Capacitance line-PG	≤ 16 pF
Operating temperature	-40 °C to +80 °C (-40 °F to +176 °F)
IP rating (plugged in)	IP 20
Test method	IEC 61643-21, UL 497B
Material	Polyamide PA 6.6, yellow
Weight	22 g (0,05 lbs)
Dimensions	12 x 45 x 51 mm (WxHxD) 0.5 x 1.8 x 2 inch (WxHxD)

Not included in delivery

Overvoltage protection - Base BXT BAS 922843

Optional accessories

Module condition monitoring DRC MCM XT 922804

Module condition monitoring DRC SCM XT 922805

Note

Insertable in and earthing via Base BXT BAS.

Keep decoupling distance from the fire control panel of at least 5 m cable length.

Circuit diagram

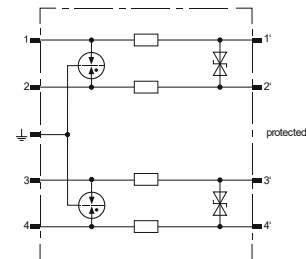

Approvals / marking





System accessories

Overvoltage protection - EMC, Information technology

Overvoltage protection BVT ALD 36

Part no.: 922821

Energy-coordinated, DIN rail mounted combined lightning current and surge arrester for protecting unearthed DC power supply systems.



Product features

- For DC supply systems up to nominal currents of 7 A
- Low voltage protection level
- For installation in conformity with the lightning protection zone concept at the interfaces from $0_A -2$ and higher

Note

For mounting on 35 mm DIN rails acc. to EN 60715. Connection and earthing via screw terminal.

Technical specifications



Arrester class	Coarse, medium and fine protection
Rated voltage DC	36 V
Max. continuous operating voltage DC	45 V
Rated current at 80 °C/176 °F	4 A
Rated current at 45 °C/113 °F	7 A
D1 Lightning impulse current (10/350 µs) per line	2.5 kA
C2 Nominal discharge current (8/20 µs) per line	10 kA
Series resistance per line	22 µH
Capacitance line-line	≤ 1.5 nF
Operating temperature	-40 °C to +80 °C (-40 °F to +176 °F)
Cross-sectional area, solid	0.05-6.0 mm ²
Cross-sectional area, flexible	0.05-4.0 mm ²
IP rating	IP 20
Test method	IEC 61643-21 / EN 61643-21
Material	Thermoplastic, UL 94 V-0, yellow
Weight	110 g (0.24 lbs)
Dimensions	27 x 90 x 65 mm (WxHxD) 1.1 x 3.5 x 2.6 inch (WxHxD)

Circuit diagram

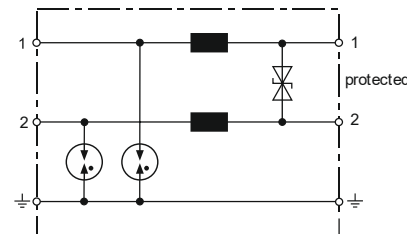

Approvals / marking





System accessories

Overvoltage protection - EMC, Information technology

Overvoltage protection BVT RS485 5

Part no.: 922820



Surge arrester for a wide range of applications, e.g. for balanced four-wire RS485/422 interfaces or temperature sensors. Direct or indirect shield earthing, connection of a signal ground (SG).

Product features

- Terminals for four bus lines and SG
- Direct or indirect shield earthing
- For installation in conformity with the lightning protection zone concept at the interfaces from $O_B -2$ and higher

Note

For mounting on 35 mm (1.4 inch) DIN rails acc. to EN 60715. Connection and earthing via screw terminal. Keep decoupling distance from the fire control panel of at least 5 m cable length.

Technical specifications



Arrester class	Medium and fine protection
Rated voltage DC	5 V
Max. continuous operating voltage DC	6 V
Rated current	0.5 A
D1 Lightning impulse current (10/350 μ s) per line	0.8 kA
C2 Nominal discharge current (8/20 μ s) per line	10 kA
Series resistance per line	1.8 Ω
Capacitance line-line	≤ 5 nF
Operating temperature	-40 °C to +80 °C (-40 °F to +176 °F)
IP rating	IP 20
Cross-sectional area, solid	0.08-2.5 mm ²
Cross-sectional area, flexible	0.08-2.5 mm ²
Test method	IEC 61643-21 / EN 61643-21, UL 497B
Material	Thermoplastic, UL 94 V-0, yellow
Weight	182 g (0.4 lbs)
Dimensions	54 x 97 x 65 mm (WxHxD) 2.1 x 3.8 x 2.6 inch (WxHxD)

Circuit diagram

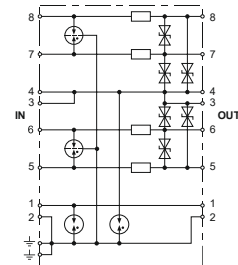

Approvals / marking





System accessories

Overvoltage protection - EMC, Information technology

Overvoltage protection USD 25 V24 HS S B



Product features

- Plug-in surge arrester with two-stage protective circuit
- For installation in conformity with the lightning protection zone concept at the interfaces from $O_B - 2$ and higher

Technical specifications



Arrester class	Medium and fine protection
Monitoring system	LifeCheck®
Rated voltage DC	12 V
Max. continuous operating voltage DC	12.5 V
C2 Nominal discharge current (8/20 µs) line-PG	2.5 kA
C2 Nominal discharge current (8/20 µs) SG-PG	7.5 kA
Series resistance per line	15 Ω
Pinning	Ad: 2/3/4/5/6/8/20 Signal Ground: 7 Protective Ground: 1
Operating temperature	-40 °C to +80 °C (-40 °F to +176 °F)
Test method	IEC 61643-21 / EN 61643-21
Weight	151 g (0.33 lbs)
Dimensions	86 x 55 x 16 mm (WxHxD) 3.4 x 2.2 x 0.6 inch (WxHxD)

Part no.: 922860

Energy-coordinated two-stage arrester for V24 interfaces with handshake. 25-pin SUB-D version.

Optional accessories

Adapter D-SUB 25M-9F	922796
Adapter D-SUB 25F-9M	922797

Note

Connection input: SUB-D 25 plug
Connection output: SUB-D 25 socket
Earthing via earthing screw or DIN rail

Circuit diagram

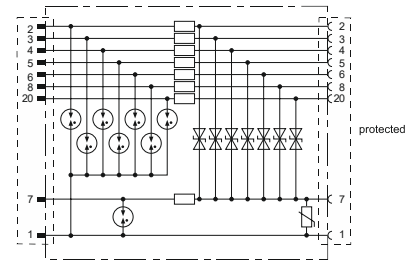

Approvals / marking





System accessories

Overvoltage protection - EMC, Information technology

Overvoltage protection DPA M CAT6 RJ45S 48



Technical specifications



Arrester class	Medium and fine protection
Rated voltage DC	48 V
Max. continuous operating voltage DC	48 V
Max. continuous operating voltage DC pair-pair (PoE)	57 V
Rated current at 45 °C/113 °F	1.0 A
D1 Lightning impulse current (10/350 µs) per line	1.0 kA
C2 Nominal discharge current (8/20 µs) line-line	150 A
C2 Nominal discharge current (8/20 µs) line-PG	2.5 kA
C2 Total nominal discharge current (8/20 µs) line-PG	10 kA
C2 Nominal discharge current (8/20 µs) pair-pair (PoE)	150 A
Cut-off frequency	250 MHz
Capacitance line-line	≤ 165 pF
Capacitance line-PG	≤ 255 pF
Pinning	1/2, 3/6, 4/5, 7/8
Connecting line	A = ca. 0.5 m, G = ca. 3 m
Connection input/output	RJ45-connecting line/ RJ45-connecting line
Connector	Stewart 39 series
Operating temperature	-20 °C to +60 °C (-4 °F to +140 °F)
IP rating	IP 20
Test method	IEC 61643-21/ EN 61643-21
Transmission class acc. to ISO/IEC 11801	Cat. 6
Transmission class acc. to EN 50173-1	Class EA
Transmission class acc. to ANSI/TIA/EIA-568	Cat. 6A in the Channel
Material	Zinc, die-casting
Weight	244 g (0.54 lbs)

Part no.: 922862

Universal arrester for Industrial Ethernet, Power over Ethernet (PoE+ acc. to IEEE 802.3at up to 57 V) and similar applications in structured cabling systems according to class EA up to 500 MHz.

Fully shielded type with sockets for DIN rail mounting.

Product features

- Ideally suited for retrofitting, protection of all lines
- CAT 6A in the channel according to ANSI/TIA/EIA-568
- Power over Ethernet (PoE+ according to IEEE 802.3at)
- For installation in conformity with the lightning protection zone concept at the interfaces from 0_B -2 and higher

Included in delivery

Fixing material
Earthing bracket with flat connector sleeve

Note

For mounting on DIN rails acc. to EN 60715

Circuit diagram

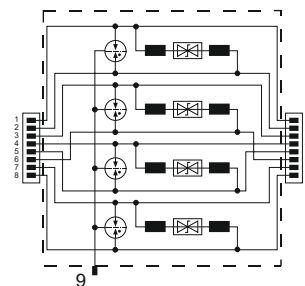

Approvals / marking





System accessories

Overvoltage protection - EMC, Information technology

Overvoltage protection DPA M CLE RJ45B 48



Product features

- Ideally suited for retrofitting, protection of all lines
- CAT 6A in the channel according to ANSI/TIA/EIA-568
- Power over Ethernet (PoE+ according to IEEE 802.3at)
- For installation in conformity with the lightning protection zone concept at the interfaces from $O_b -2$ and higher

Technical specifications



Arrester class	Medium and fine protection
Rated voltage DC	48 V
Max. continuous operating voltage DC	48 V
Max. continuous operating voltage DC	34 V
Max. continuous operating voltage DC pair pair (PoE)	57 V
Rated current	1.0 A
D1 Lightning impulse current (10/350 μ s) per line	0.5 kA
C2 Nominal discharge current (8/20 μ s) line-line	150 A
C2 Nominal discharge current (8/20 μ s) line-PG	2.5 kA
C2 Total nominal discharge current (8/20 μ s) line-PG	10 kA
C2 Nominal discharge current (8/20 μ s) pair-pair (PoE)	150 A
Cut-off frequency	250 MHz
Capacitance line-line	≤ 30 pF
Capacitance line-PG	≤ 25 pF
Pinning	1/2, 3/6, 4/5, 7/8
Connection input/output	RJ45-socket / RJ45-socket
Operating temperature	-40 °C to +80 °C (-40 °F to +176 °F)
IP rating	IP 10
Test method	IEC 61643-21/ EN 61643-21/ UL 497B
Material	Zinc, die-casting
Weight	123 g (0.27 lbs)

Part no.: 922863

Universal arrester for Industrial Ethernet, Power over Ethernet (PoE+ acc. to IEEE 802.3at up to 57 V) and similar applications in structured cabling systems according to class E up to 250 MHz. Protection of all pairs by means of powerful gas discharge tubes and one adapted filter matrix per pair. Fully shielded type with sockets for DIN rail mounting.

Included in delivery

Fixing material
Earthing bracket with flat connector sleeve

Not included in delivery

Patch-cable

Note

For mounting on DIN rails acc. to EN 60715

Circuit diagram

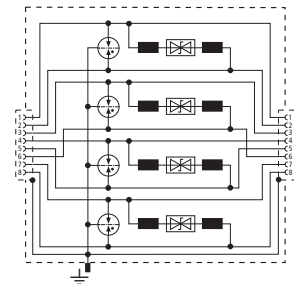

Approvals / marking





System accessories

Monitoring and test equipment

Module condition monitoring

DRC MCM XT



Technical specifications

Input voltage range DC	18-48 V
Max. rated current consumption	100 mA
RFID-Transmission frequency	125 kHz
Testing of	Up to 10 arresters BXT only in non-explosive atmosphere! Observe thread measure!
Report change of arresters recommended	LED, communication contact (NC/NO))
Control element	multiway button, DIP-switch
Display element	3-color-LED (green, orange, red)
Test cycle	continuous
Operating temperature monitoring up to 10 BXT arresters	-20 °C to +60 °C (-4 °F to +140 °F)
Operating temperature monitoring 8 BXT - arrester	-40 °C to +80 °C (-40 °F to 176 °F)
Max. terminal cross-section	0.08-2.5 mm ² solid/ flexible
Type of remote signalling contact	NO/NC contact
Technical data of remote signalling contact	Contact resistance < 25 Ω Leakage current < 1 µA
Max. switching capacity	350 V / 0.12 A
IP rating	IP 20
Material	Polyamide PA 6.6, grey
Weight	180 g (0.4 lbs)
Dimensions	12 x 66 x 90 mm (WxHxD) 0.5 x 2.6 x 3.5 inch (WxHxD)

Part no.: 922804

DIN rail mounted device with integrated LifeCheck® sensor for condition monitoring of max. 10 LifeCheck®-equipped BXT / BXTU arresters. Visual operating state indication via three-colored LED combined with remote signaling function (break or make contact). An RS 485 interface allows to interconnect up to 15 Modules DRC MCM XT.

The free „Status Display and Service Console“ software can optionally be used via an RS485 interface converter. With the software a remote condition monitoring of all arresters is possible by PC.

Included in delivery

Base part
Module monitoring
Brief instructions
Designation system

Optional accessories

PC-reporting software

Note

For mounting on 35 mm DIN rails acc. to EN 60715

Circuit diagram

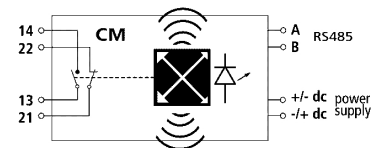

Approvals / marking



Module condition monitoring

DRC SCM XT

Weight	54 g (0,1 lbs)
--------	-----------------

Part no.: 922805

Otherwise like part no. 922804



System accessories

Monitoring and test equipment

Test device PM 20



Product features

- Combined testing of protective circuits with gas discharge tubes, varistors and Zener diodes
- Easy and flexible use
- Measuring accessories included

Technical specifications

Rated voltage DC	8 – 12 V
Test parameter: Test voltage DC	max. 1250 V
Test parameter: Test current (reference voltage) DC	1 mA, constant
Measured value indication	alphanumeric, 8-digit LCD
Test output sockets	Safety pole terminals (4 mm) Positive pole: red color, Negative pole: black color
Testing period	≤ 1.5 sec.
Number of individual tests during battery operation	typically 2000
Weight	1,32 kg (2.91 lbs)
Dimensions of the storage bag	300 x 110 x 110 mm 11.8 x 4.3 x 4.3 inch

Part no.: 922801

Combined device for testing the sparkover voltage of surge arresters (with gas discharge tubes / varistors / Zener diodes). Storage bag and measuring accessories included.

Included in delivery

- 1 Test device PM 20
- 2 Test leads, each 1 m long
- 2 Safety tapping test clips
- 1 Plug-in power supply unit 230 V AC
- 1 Storage bag

Not included in delivery

- Test adapter PA DRL 922799
- Test adapter PA BXT 922800

Approvals / marking



Test device DRC LC M3+



Technical specifications

Alarm	visual and audible
PC Connection	via USB
Weight	1,06 kg (2.34 lbs)
Dimensions of the storage case	340 x 275 x 83 mm 13.4 x 10.8 x 3.3 inch

Part no.: 922802

Portable device with LifeCheck® sensor for flexible use. Fast and easy testing of LifeCheck®-equipped arresters. Documentation via PC database.

Included in delivery

- 1 Reading device
- 1 LifeCheck®-Sensor
- 1 USB cable
- 1 Recharger
- 1 Software
- 1 Test module for reference

Spare parts

- Spare LifeCheck®-Sensor LCS DRC BXT 922883

Approvals / marking





System accessories

Monitoring and test equipment

Test device PA DRL



Part no.: 922799

To be connected to PM 10 / PM 20. For inserting and testing protection modules.

Included in delivery

Test adapter PA DRL

Not included in delivery

Test device PM 20 922801

Note

For protection modules:

Plug-in block DRL 10 B 180 FSD 922789

Overvoltage protection plug DRL RD 48 922790

Technical specifications

Weight	924 g (2.04 lbs)
--------	------------------

Test device PA BXT



Part no.: 922800

To be connected to PM 10 / PM 20. For inserting and testing protection modules.

Included in delivery

Test adapter PA BXT

Not included in delivery

Test device PM 20 922801

Note

For protection modules:

Overvoltage protection plugs -

BXT ML2 BD S 24 922839

BXT ML2 BD S 48 922840

BXT ML2 MY E 110 922842

BXT ML4 B 180 922847

BXT ML4 BD 48 922848

BXT ML4 BC 24 922849

BXT M2 BD S EX 24 922854

BXT ML4 MY 110 922855

Technical specifications

Weight	800 g (1.76 lbs)
--------	------------------



System accessories

Overvoltage protection - EMC, Information technology, Ex

Overvoltage protection BXT M2 BD S EX 24



Product features

- Self-capacitance and self-inductance negligibly small
- For installation in conformity with the lightning protection zone concept at the interfaces from $O_B -2$ and higher

Technical specifications



Arrester class	medium and fine protection
Rated voltage DC	24 V
Max. continuous operating voltage DC	36 V
Rated current at +45 °C (+113 °F)	1.0 A
Max. input voltage acc. to EN 60079-11	30 V
Max. input current acc. to EN 60079-11	0.5 A
D1 Lightning impulse current (10/350 μ s) per line	1 kA
C2 Nominal discharge current (8/20 μ s) per line	5 kA
Series resistance per line	1.0 Ω
Capacitance line-line	≤ 0.8 nF
Capacitance line-PG	≤ 16 pF
Operating temperature	-40 °C to +80 °C (-40 °F to +176 °F)
IP rating (plugged-in)	IP 20
Test method	IEC 61643-21 / EN 61643-21
Material	Polyamide PA 6.6, blue
Weight	21 g (0.05 lbs)
Dimensions	12 x 45 x 51 mm (WxHxD) 0.5 x 1.8 x 2 inch (WxHxD)

Part no.: 922854

Space-saving surge arrester module for protecting one pair of intrinsically safe measuring circuits and bus systems, direct or indirect shield earthing, insulation strength > 500 V line-earth.

Not included in delivery

Overvoltage protection - Base BXT BAS EX 922844

Optional accessories

Partition TW DRC MCM EX 922806
Module condition monitoring DRC MCM XT 922804
Module condition monitoring DRC SCM XT 922805

Note

Insertable in and earthing via Base BXT BAS Ex

Circuit diagram

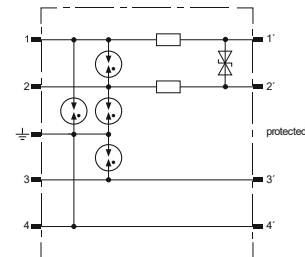

Approvals / marking

Ex conformity acc. to 2014/34/EU:

Ⓢ II 2(1) G Ex ia IIC T4, T5, T6, Gb

Ⓢ II 3G Ex nA IIC T4, T5, T6 Gc

Type examination certificate:

KEMA 09ATEX0178X

KEMA 09ATEX0177X

IECEx conformity:

IECEx KEM 09.0077X





System accessories

Overvoltage protection - EMC, Information technology, Ex

Overvoltage protection BXT ML2 BD HF EX 6



Product features

- Self-capacitance and self-inductance negligibly small
- For installation in conformity with the lightning protection zone concept at the interfaces from $O_B -2$ and higher

Technical specifications



Arrester class	Medium and fine protection
Monitoring system	LifeCheck®
Rated voltage DC	6 V
Max. continuous operating voltage DC	6 V
Max. input voltage acc. to EN 60079-11	4.2 V
Max. input current acc. to EN 60079-11	4.8 A
D1 Lightning impulse current (10/350 µs) per line	1 kA
C2 Nominal discharge current (8/20 µs) per line	5 kA
Capacitance line-line	≤ 25 pF
Capacitance line-PG	≤ 20 pF
Operating temperature	-40 °C to +80 °C (-40 °F to +176 °F)
IP rating (plugged-in)	IP 20
Test method	IEC 61643-21 / EN 61643-21
Material	Polyamide PA 6.6, blue
Weight	20 g (0.04 lbs)
Dimensions	12 x 45 x 51 mm (WxHxD) 0.5 x 1.8 x 2 inch (WxHxD)

Part no.: 922859

Space-saving LifeCheck-equipped surge arrester module for protecting one pair in intrinsically safe measuring circuits and RS485 bus systems. Insulation strength > 500 V line-earth.

If LifeCheck detects thermal and electrical overload, the arrester has to be replaced.

This status is indicated contactlessly by Module condition monitoring DRC SCM XT / DRC MCM XT or test device DRC LC M3.

Not included in delivery

Overvoltage protection - Base BXT BAS EX 922844

Optional accessories

Partition TW DRC MCM EX 922806

Module condition monitoring DRC MCM XT 922804

Module condition monitoring DRC SCM XT 922805

Circuit diagram

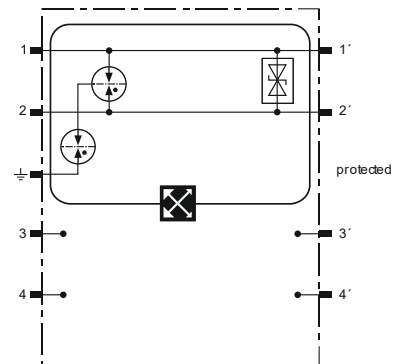

Approvals / marking

Ex conformity acc. to 2014/34/EU:

Ⓜ II 2(1) G Ex ia IIC T4, T5, T6, Gb

Ⓜ II 2G Ex ib IIC T4, T5, T6 Gb

Type examination certificate:

KEMA 06ATEX0274

IECEx conformity:

IECEx DEK 11.0078X





















System accessories

Overvoltage protection - EMC

Overvoltage protection - operation with fire detection and suppression control panel FMZ 5000

Surge arrester Allocation table interfaces Energy technology System FMZ 5000				Mains voltage
Overvoltage protection Part. no./ designation	Area- crossover	Coarse- Medium- Fine T1 - T2 - T3	Mains power (main- and subdistribution)	Control voltage 115 / 230 V; Device protection X101
922864 DSH TN 255 	0/A - 1			X
922865 DSH TT 255 	0/A - 1			X
922866 DSH TNS 255 	0/A - 1			X
922869 DV M TT 2P 255 FM 	0/A - 1		X	
922874 DG S 320 FM 	0/B - 1		X	
922876 DG M TT 2P 275 FM 	0/B - 1		X	
922878 DG M TNS 275 FM 	0/B - 1		X	
922882 DR M 2P 255 FM 	1 - 2			X



System accessories

Overvoltage protection - EMC, Energy technology

Overvoltage protection DSH TN 255

Part no.: 922864



Application-optimized and prewired combined lightning current and surge arrester for single-phase TN systems. Compact, space-saving design with reduced protection capability.

Product features

- Application-optimized and prewired spark-gap-based type 1 and type 2 combined lightning current and surge arrester
- Compact and space-saving design due to spark gap technology without venting means with a width of only 1 module / pole
- Including protection of terminal equipment

Optional accessories

Terminal-pin shaped STAK 25

922879

Technical specifications



SPD acc. to EN 61643-11 / IEC 61643-11	type 1 + type 2 / class I + class II
Energy coordination with terminal equipment (≤ 5 m)	type 1 + type 2 + type 3
Rated voltage AC	230 V (50/60 Hz)
Max. continuous operating voltage AC	255 V (50/60 Hz)
Lightning impulse current (10/350 μ s) [L,N-PE]	12,5 kA
Operating temperature	-40 °C to +80 °C (-40 °F to +176 °F)
Operating state / fault indication	green / red
Number of ports	1
Cross-sectional area (L, N, PE) (min.)	1.5 mm ² solid / flexible
Cross-sectional area (L, N, PE) (max.)	35 mm ² stranded/ 25 mm ² flexible
IP rating	IP 20
Material	Thermoplastic, UL 94 V-0, red
Weight	250 g (0.55 lbs)
Dimensions	36 x 90 x 65 mm (WxHxD) 1.4 x 3.5 x 2.6 inch (WxHxD)
Capacity	2 mods., DIN 43880

Note

For mounting on 35 mm DIN rails acc. to EN 60715.

Circuit diagram

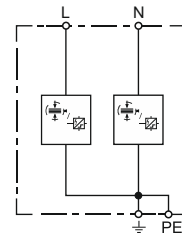

Approvals / marking



Trusted above all.

Viking GmbH | Industriestr. 10/12 | D-23840 Bad Oldesloe | www.viking-emea.com





System accessories

Overvoltage protection - EMC, Energy technology

Overvoltage protection DSH TT 255

Part no.: 922865



Application-optimized and prewired combined lightning current and surge arrester for TT and TN-S systems („3+1“ circuit). Compact, space-saving design with reduced protection capability without remote signaling contact.

Product features

- Application-optimized and prewired spark-gap-based type 1 and type 2 combined lightning current and surge arrester
- Spark gap technology without venting means with a width of only 1 module / pole
- Protection of terminal equipment

Optional accessories

Terminal-pin shaped STAK 25

922879

Technical specifications



SPD acc. to EN 61643-11 / IEC 61643-11	type 1 + type 2 / class I + class II
Energy coordination with terminal equipment (≤ 5 m)	type 1 + type 2 + type 3
Rated voltage AC	230 / 400 V (50/60 Hz)
Max. continuous operating voltage AC	255 V (50/60 Hz)
Lightning impulse current (10/350 μ s) [L-N],[N-PE]	12,5 / 50 kA
Operating temperature	-40 °C to +80 °C (-40 °F to +176 °F)
Operating state / fault indication	green / red
Number of ports	1
Cross-sectional area (L1, L2, L3, N, PE, shield) (min.)	1.5 mm ² solid / flexible
Cross-sectional area (L1, L2, L3, N, PE, shield) (max.)	35 mm ² stranded/ 25 mm ² flexible
IP rating	IP 20
Material	Thermoplastic, UL 94 V-0, red
Weight	480 g (1.06 lbs)
Dimensions	71.6 x 90 x 65 mm (WxHxD) 2.8 x 3.5 x 2.6 inch (WxHxD)
Capacity	4 mods., DIN 43880

Note

For mounting on 35 mm DIN rails acc. to EN 60715.

Circuit diagram

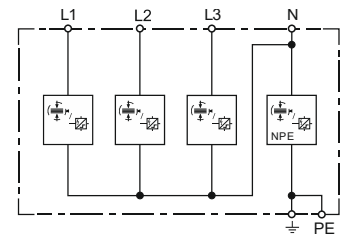

Approvals / marking



Trusted above all.

Viking GmbH | Industriestr. 10/12 | D-23840 Bad Oldesloe | www.viking-emea.com





System accessories

Overvoltage protection - EMC, Energy technology

Overvoltage protection DSH TNS 255

Part no.: 922866



Application-optimized and prewired combined lightning current and surge arrester for TN-S systems. Compact, space-saving design with reduced Protection capability without remote signaling contact.

Product features

- Application-optimized and prewired spark-gap-based type 1 and type 2 combined lightning current and surge arrester
- Spark gap technology without venting means with a width of only 1 module / pole
- Including protection of terminal equipment

Optional accessories

Terminal-pin shaped STAK 25

922879

Technical specifications



SPD acc. to EN 61643-11 / IEC 61643-11	type 1 + type 2 / class I + class II
Energy coordination with terminal equipment (≤ 5 m)	type 1 + type 2 + type 3
Rated voltage AC	230 / 400 V (50 / 60 Hz)
Max. continuous operating voltage AC	255 V (50 / 60 Hz)
Lightning impulse current (10/350 μ s) [L, N-PE]	12.5 kA
Operating temperature	-40 °C to +80 °C (-40 °F to +176 °F)
Operating state / fault indication	green / red
Number of ports	1
Cross-sectional area (L1, L2, L3, N, PE, shield) (min.)	1.5 mm ² solid / flexible
Cross-sectional area (L1, L2, L3, N, PE, shield) (max.)	35 mm ² stranded / 25 mm ² flexible
IP rating	IP 20
Material	Thermoplastic, UL 94 V-0, red
Weight	480 g (1.06 lbs)
Dimensions	71.6 x 90 x 65 mm (WxHxD) 2,8 x 3,5 x 2,6 inch (WxHxD)
Capacity	4 mods., DIN 43880

Note

For mounting on 35 mm DIN rails acc. to EN 60715.

Circuit diagram

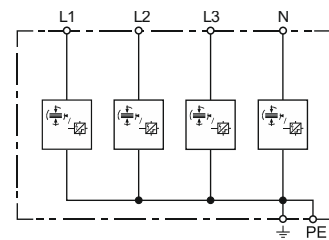

Approvals / marking



Trusted above all.

Viking GmbH | Industriestr. 10/12 | D-23840 Bad Oldesloe | www.viking-emea.com





System accessories

Overvoltage protection - EMC, Energy technology

Overvoltage protection DV M TT 2P 255 FM



Part no.: 922869

Combined lightning current and surge arrester for single-phase TT and TN-S systems („1+1“ circuit); with floating remote signaling contact.

Product specifications

- Application-optimized and prewired spark-gap-based type 1 and type 2
- Compact and space-saving design due to spark gap technology without venting means with a width of only 1 module / pole
- Allows compact lightning equipotential bonding including protection of terminal equipment

Optional accessories

Terminal - pin connection STAK 2X16 922778

Technical specifications



SPD acc. to EN 61643-11 / IEC 61643-11	type 1 + type 2 / class I + class II
Energy coordination with terminal equipment (≤ 5 m)	type 1 + type 2 + type 3
Rated voltage AC	230 / 400 V (50 / 60 Hz)
Max. continuous operating voltage AC [L-N]	255 V (50 / 60 Hz)
Max. continuous operating voltage AC [N-PE]	255 V (50 / 60 Hz)
Lightning impulse current (10/350 μ s) [L-N] / [N-PE]	25 / 50 kA
Operating temperature [parallel] / [series]	-40 °C to +80 °C (-40 °F to +176 °F) / -40 °C to +60 °C (-40 °F to +140 °F)
Operating state / fault indication	green / red
Number of ports	1
Cross-sectional area (L, L', N, N', PE, shield) (min.)	10 mm ² solid / flexible
Cross-sectional area (L, N, PE) (max.)	50 mm ² stranded / 35 mm ² flexible
Cross-sectional area (L', N', shield) (max.)	35 mm ² stranded / 25 mm ² flexible
IP rating	IP 20
Material	Thermoplastic, UL 94 V-0, red
Weight	664 g (1.46 lbs)
Dimensions	72 x 90 x 73 mm (WxHxD) 2,8 x 3,5 x 2,9 inch (WxHxD)
Capacity	4 mods., DIN 43880

Note

For mounting on 35 mm (1.4 inch) DIN rails acc. to EN 60715.

Spare parts

Overvoltage protection DV MOD 255 922867
Overvoltage protection DV MOD NPE 50 922868

Circuit diagram

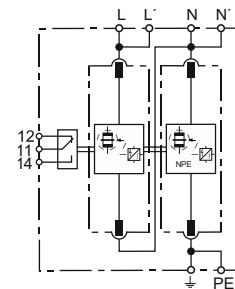

Approvals / marking





System accessories

Overvoltage protection - EMC, Energy technology

Overvoltage protection DG S 320 FM

Part no.: 922874

Pluggable single-pole surge arrester consisting of a base part and a plug-in protection module; with floating remote signaling contact.

Product features

- High discharge capacity due to heavy-duty zinc oxide varistor
- High reliability due to thermo control SPD monitoring device

Optional accessories

Terminal-pin shaped STAK 25

922879

Technical specifications



SPD acc. to EN 61643-11/ IEC 61643-11	type 2 / class II
Rated voltage AC	230 V (50 / 60 Hz)
Max. continuous operating voltage AC	320 V (50 / 60 Hz)
Max. continuous operating voltage DC	420 V
Max. discharge current (8/20 μ s)	40 kA
Operating temperature	-40 °C to + 80 °C (-40 °F to +176 °F)
Operating state / fault indication	green / red
Number of ports	1
Cross-sectional area (min.)	1.5 mm ² solid / flexible
Cross-sectional area (max.)	35 mm ² stranded/ 25 mm ² flexible
IP rating	IP 20
Material	Thermoplastic, UL 94 V-0, red
Weight	137 g (0.3 lbs)
Dimensions	15.3 x 90 x 73 mm (LxHxW) 0.6 x 3.5 x 2.9 inch (LxHxW)
Capacity	1 TE, DIN 43880

Note

For mounting on 35 mm DIN rails acc. to EN 60715.

Spare parts

Overvoltage protection DG MOD 320

922871

Circuit diagram

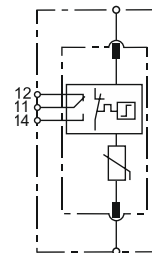

Approvals / marking



Trusted above all.

Viking GmbH | Industriestr. 10/12 | D-23840 Bad Oldesloe | www.viking-emea.com





System accessories

Overvoltage protection - EMC, Energy technology

Overvoltage protection DG M TT 2P 275 FM



Product features

- High discharge capacity due to heavy-duty zinc oxide varistors / spark gaps
- High reliability due to thermo control

Technical specifications



SPD acc. to EN 61643-11 / IEC 61643-11	type 2 / class II
Rated voltage AC	230 V (50 / 60 Hz)
Max. continuous operating voltage AC [L-N]	275 V (50 / 60 Hz)
Max. continuous operating voltage AC [N-PE]	255 V (50 / 60 Hz)
Max. discharge current (8/20 μ s)	40 kA
Lightning impulse current (10/350 μ s) [N-PE]	12 kA
Operating temperature	-40 °C to +80 °C (-40 °F to +176 °F)
Operating state / fault indication	green / red
Number of ports	1
Cross-sectional area (min.)	1.5 mm ² solid / flexible
Cross-sectional area (max.)	35 mm ² stranded/ 25 mm ² flexible
IP rating	IP 20
Material	Thermoplastic, UL 94 V-0, red
Weight	228 g (0.5 lbs)
Dimensions	15.3 x 90 x 73 mm (WxHxD) 0.6 x 3.5 x 2.9 inch (WHxD)
Capacity	2 mods., DIN 43880

Approvals / marking



Part no.: 922876

Modular surge arrester for single-phase TT and TN systems („1+1“ circuit), consisting of a base part and plug-in protection module. With floating remote signaling contact.

Optional accessories

Terminal-pin shapes STAK 25

922879

Spare parts

Overvoltage protection DG MOD 275

922870

Overvoltage protection DG MOD NPE

922872

Note

For mounting on 35 mm DIN rails acc. to EN 60715.

Circuit diagram

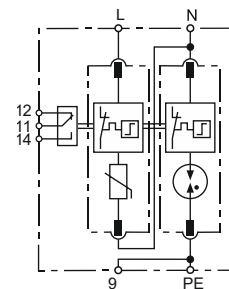



System accessories

Overvoltage protection - EMC, Energy technology

Overvoltage protection DG M TNS 275 FM



Product features

- Prewired complete unit consisting of a base part and plug-in protection modules
- High reliability due to thermo control
- High discharge capacity due to heavy-duty zinc oxide varistors / spark gaps

Technical specifications



SPD acc. to EN 61643-11 / IEC 61643-11	type 2 / class II
Rated voltage AC	230 / 400 V (50 / 60 Hz)
Max. continuous operating voltage AC [L-N]	275 V (50 / 60 Hz)
Max. continuous operating voltage AC [N-PE]	255 V (50 / 60 Hz)
Max. discharge current (8/20 μ s)	40 kA
Operating temperature	-40 °C to +80 °C (-40 °F to +176 °F)
Operating state / fault indication	green / red
Number of ports	1
Cross-sectional area (min.)	1.5 mm ² solid / flexible
Cross-sectional area (max.)	35 mm ² stranded/ 25 mm ² flexible
IP rating	IP 20
Material	Thermoplastic, UL 94 V-0, red
Weight	453 g (1.0 lbs)
Dimensions	15.3 x 90 x 73 mm (WxHxD) 0.6 x 3.5 x 2.9 inch (WHxD)
Capacity	4 mods., DIN 43880

Approvals / marking



Part no.: 922878

Modular surge arrester for single-phase TT and TN systems („1+1“ circuit), consisting of a base part and plug-in protection module. With floating remote signaling contact.

Optional accessories

Terminal-pin shapes STAK 25

922879

Spare parts

Overvoltage protection DG MOD 275

922870

Note

For mounting on 35 mm DIN rails acc. to EN 60715.

Circuit diagram

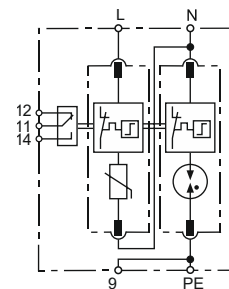



System accessories

Overvoltage protection - EMC, Energy technology

Overvoltage protection DR M 2P 255 FM

Part no: 922882

Two-pole surge arrester consisting of a base part and plug-in protection module. With floating remote signaling contact.



Product features

- High discharge capacity due to heavy-duty zinc oxide varistor / spark gap combination
- Energy coordination with other arresters of overvoltage protection for energy technology

Spare parts

Overvoltage protection DR MOD 255

922880

Note

For mounting on 35 mm DIN rails acc. to EN 60715.

Technical specifications



SPD acc. to EN 61643-11/ IEC 61643-11	type 3 / class III
Rated voltage AC	230 V (50 / 60 Hz)
Max. continuous operating voltage AC	255 V (50 / 60 Hz)
Max. continuous operating voltage DC	255 V
Total discharge current (8/20 μ s) [L+N-PE]	5 kA
Operating temperature	-40 °C to +80 °C (-40 °F to +176 °F)
Operating state / fault indication	green / red
Number of ports	1
Cross-sectional area (min.)	0.5 mm ² solid / flexible
Cross-sectional area (max.)	4 mm ² solid / 2.5 mm ² flexible
Type of remote signaling contact	Changeover contact
IP Rating	IP 20
Material	Thermoplastic UL 94 V-0, red
Weight	102 g (0.22 lbs)
Capacity	1 mod., DIN 43880
Dimensions	15.3 x 90 x 73 mm (WxHxD) 0.6 x 3.5 x 2.9 inch (WxHxD)

Circuit diagram

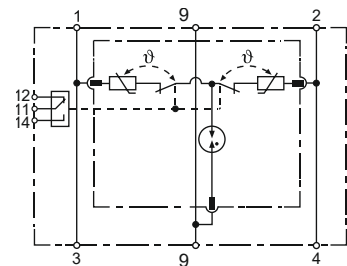

Approvals / marking





System accessories

Overvoltage protection - EMC, Energy technology

Overvoltage protection DG M TN S 275

Part no: 922877

Two-pole surge arrester consisting of a base part and plug-in protection module.



Product features

- High discharge capacity due to heavy-duty zinc oxide varistor / spark gap combination

Note

For mounting on 35 mm DIN rails acc. to EN 60715.

Technical specifications



SPD acc. to EN 61643-11/ IEC 61643-11	type 2 / class III
Rated voltage AC	230 V / 400 V (50 / 60 Hz)
Max. continuous operating voltage AC	275 V (50 / 60 Hz)
Max. continuous operating voltage DC	V
Total discharge current (8/20 μ s) [L+N-PE]	kA
Operating temperature	-40 °C to +80 °C (-40 °F to +176 °F)
Operating state / fault indication	green / red
Number of ports	1
Cross-sectional area (min.)	1.5 mm ² solid / flexible
Cross-sectional area (max.)	35 mm ² solid / 25 mm ² flexible
Type of remote signaling contact	
IP Rating	IP 20
Material	Thermoplastic UL 94 V-0, red
Weight	443 g (0.98 lbs)
Capacity	4 mod., DIN 43880
Dimensions	75 x 90 x 73 mm (WxHxD) 2.95 x 3.5 x 2.9 inch (WxHxD)

Circuit diagram

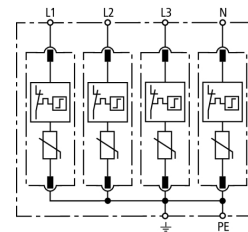

Approvals / marking





System accessories

Overvoltage protection - EMC, Energy technology

Overvoltage protection DG M TT 2P 275

Part no: 922875

Modular arrester for single-phase TT and TN systems.



Product features

- High discharge capacity due to heavy-duty zinc oxide varistor / spark gap combination

Note

For mounting on 35 mm DIN rails acc. to EN 60715.

Technical specifications



SPD acc. to EN 61643-11/ IEC 61643-11	type 2 / class III
Rated voltage AC	230 V (50 / 60 Hz)
Max. continuous operating voltage AC	275 V (50 / 60 Hz)
Max. continuous operating voltage DC	V
Total discharge current (8/20 μ s) [L+N-PE]	kA
Operating temperature	-40 °C to +80 °C (-40 °F to +176 °F)
Operating state / fault indication	green / red
Number of ports	1
Cross-sectional area (min.)	1.5 mm ² solid / flexible
Cross-sectional area (max.)	35 mm ² solid / 25 mm ² flexible
Type of remote signaling contact	
IP Rating	IP 20
Material	Thermoplastic UL 94 V-0, red
Weight	242 g (0.53 lbs)
Capacity	2 mod., DIN 43880
Dimensions	36 x 90 x 73 mm (WxHxD) 1.42 x 3.5 x 2.9 inch (WxHxD)

Circuit diagram

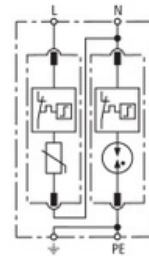

Approvals / marking





System accessories

Overvoltage protection – EMC, accessories

Routing Block LSA / Terminal TL2 10 DA CC

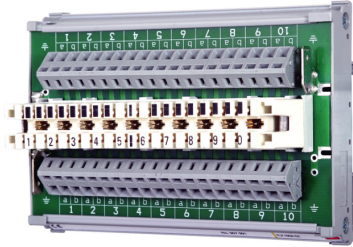

Product features

- Optional connection to LSA or spring-loaded terminals
- Routing of different wire diameters
- DRL adapted to DIN rail systems

Technical specifications

Carrying capacity of connection components D1 Total lightning impulse current (10/350 µs)	5 kA
Operating temperature	-40 °C to + 80 °C (-40 ° F to +176 °F)
Connection input/output	Spring or LSA / spring or LSA
Cross-sectional area of spring terminal, solid	0.08-2.5 mm ²
Earthing via	Mounting rail / blade terminal 6.3
Diameter of solid conductors	0.40-0.80 mm
Conductor diameter with insulation	0.70-1.60 mm
Volume resistance of IPC terminal	< 10 m Ω
IP rating	IP 20
Material	PA / PBT, grey
Weight	approx. 181 g (0.4 lbs)
Dimensions	126 x 85 x 59 mm (WxHxD) 5 x 3.4 x 2.3 inch (WxHxD)

Part no.: 922794

DIN rail mounted routing module with LSA disconnection block of the 2/10 series as well as spring-loaded terminals for variable wire connection. DPL and LSA surge arresters can be plugged into the routing module.

Included in delivery

Routing Block LSA / Terminal TL2 10 DA CC

Not included in delivery

Plug-in SPD block DRL 10 B 180 FSD 922789

Optional accessories

Earthing frame EF 10 DRL 922793
Overvoltage protection plug DRL RD 48 922790
Label holder SR DRL 922792

Spare parts

Gas discharge tube GDT 230 B3 FSD 922788

Note

Mounting on 35 mm (1.4 inch) mounting rail according to EN 60715.
Earthing via mounting rail / blade terminal 6.3 mm (0.25 inch).



System accessories

Overvoltage protection – EMC, accessories

Earthing block EL2 38EA LSA

Part no.: 922795

Series 2 for LSA technology for connecting up to 38 earth drain wires or unused signal cores. With earth wire and M4 ring cable lug.

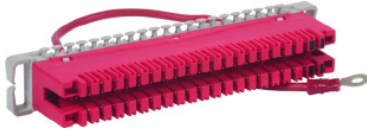

Technical specifications

Diameter of solid conductors	0.40 - 0.80 mm
Conductor diameter with insulation	0.70 - 1.50 mm
Contacting frequency for conductor diameters ≤ 0.65 mm	> 50 x
Contacting frequency for conductor diameters of 0.8 mm	≤ 50 x
Contact material	Special brass
Contact surface	Silver
Flame protection	UL 94 VO
Insulation resistance	5x 10.000 M Ω
Volume resistance of IPC terminal	< 10 m Ω
Electric strength	2 kV / 50 Hz
Color	red
Weight	approx. 60 g (0.13 lbs)

Included in delivery

Earthing block EL2 38 EA LSA
Earth wire with ring cable lug M4
Earthing via mounting rail / blade terminal 6.3 mm (0.25 inch)



System accessories

Overvoltage protection – EMC, accessories

Terminal - shield contact SAK 10 AS V4A

**Part no.:** 922773

Shield terminals for earthing cable shields on anchor bars. Suitable for lightning equipotential bonding. Can be subsequently installed without interrupting the cable shield or requiring tools for installation. Approved for use in nuclear plants with TÜV test certificate ETL 10/PB 301/97

Technical specifications

Lightning impulse current carrying capability (10/350 µs)	10 kA
Clamping range	5 to 10 mm (0.2 to 0.40 inch)
Material	NIRO
Spring pressure	21 to 27 N
Dimensions	6 x 40 x 48 mm (WxLxH) 0.24 x 1.6 x 1.9 inch (WxLxH)
Weight	26 g (0.06 lbs)

Product features

- System for anchor bars which is capable of carrying lightning currents
- Large-area shield support
- Compensates the yield of cable materials

Note

Mounting on anchor bars

Approvals / marking

ETL 10/PB 301/97

Terminal - shield contact SAK 14 AS V4A

Part no.: 922774

Technical specifications

Lightning impulse current (10/350 µs)	10 kA
Clamping range	8 to 14 mm (0.3 to 0.6 inch)
Material	NIRO
Spring pressure	30 to 76 N
Dimensions	19,5 x 40 x 50 mm (BxLxH) 0.8 x 1.6 x 2.0 inch (WxLxH)
Weight	32 g (0.07 lbs)

Otherwise like part no. 922773

Terminal - shield contact SAK 18 AS V4A

Part no.: 922775

Technical specifications

Lightning impulse current (10/350 µs)	10 kA
Clamping range	13 to 18 mm (0.5 to 0.7 inch)
Material	NIRO
Spring pressure	34 to 73 N
Dimensions	24 x 40 x 56 mm (BxLxH) 0.9 x 1.6 x 2.2 inch (WxLxH)
Weight	37 g (0.08 lbs)

Otherwise like part no. 922773

Terminal - shield contact SAK 21 AS V4A

Part no.: 922776

Technical specifications

Lightning impulse current (10/350 µs)	10 kA
Clamping range	17 to 21 mm (0.7 to 0.8 inch)
Material	NIRO
Spring pressure	30 to 63 N
Dimensions	19 x 40 x 59 mm (BxLxH) 0.8 x 1.6 x 2.3 inch (WxLxH)
Weight	49 g (0.1 lbs)

Otherwise like part no. 922773



System accessories

Overvoltage protection – EMC, accessories

Terminal - shield contact SAK 6.5 SN MS

Part no.: 922822



Shield terminals for earthing cable shields on busbars (18x3). Suitable for lightning equipotential bonding. Can be subsequently installed without interrupting the cable shield or requiring tools for installation.

Product features

- Lightning current carrying system for busbars
- Large-area shield contact
- Compensates the yield of cable materials

Technical specifications

Lightning impulse current (10/350 µs)	5 kA
Clamping range (Rd)	1.5 to 6.5 mm (0.06 to 0.26 inch)
Material	Brass, nickel-plated
Spring pressure	8 to 13 N
Dimensions	10 x 25 x 40 mm (BxLxH) 0.4 x 1.0 x 1.6 inch (WxLxH)
Weight	13 g (0.03 lbs)

Note

Mounting on busbar SN 18X3 CU 100

922828

Terminal - shield contact SAK 11 SN MS

Part no.: 922823

Technical specifications

Lightning impulse current (10/350 µs)	5 kA
Clamping range (Rd)	5 to 11 mm
Material	Brass, nickel-plated
Spring pressure	22 to 31 N
Dimensions	17 x 25 x 47 mm (BxLxH) 0.7 x 1.0 x 1.9 inch (WxHxL)
Weight	28 g (0.06 lbs)

Otherwise like part no. 922822



System accessories

Overvoltage protection – EMC, accessories

Rail support SH1 18X3 ST



Part no: 922824

Rail support suitable for DIN rail mounting. Low-impedance connection of the shield terminals to the DIN rail via the busbar.

Note

Mounting on 35 mm DIN rails according to EN 60715

Technical specifications

Version	one sided contact
Material	Steel, tin-plated
Dimensions	10 x 100 x 40 mm (BxHxT) 0.4 x 3.9 x 1.6 inch (WxHxD)
Weight	40 g (0.1 lbs)

Rail support SH3 18X3 K



Part no.: 922826

Insulated rail support for DIN rail mounting or screw connection.

Product features

- No conductive connection from the busbar to DIN rail
- Equipotential bonding via AK 35 SN 18X3 GG terminal

Note

Mounting on DIN rails or mounting plates..

Technical specifications

Material	Plastic, black
Dimensions	12 x 60 x 25 mm (BxHxT) 0.5 x 2.4 x 1.0 inch (WxHxD)
Weight	5 g (0.01 lbs)



System accessories

Overvoltage protection – EMC, accessories

Terminal - busbar AK 35 SN 18X3 GG

Part no.: 922827

Particularly suited for indirect shield earthing.



Note

Mounting on busbars

Technical specifications

Cross-sectional area	35 mm ² (0.05.inch ²)
Dimensions	12 x 30 x 37 mm (BxHxT) 0.5 x 1.2 x 1.5 inch (WxHxD)
Weight	15 g (0.03 lbs)

Busbar SN 18X3 CU 1000

Part no.: 922828

Mounting rail for shield terminals.



Product features

- Can be cut to length according to requirements
- Can be mounted onto busbar supports

Technical specifications

Material	Copper, tin-plated
Dimensions	18 x 1000 x 3 mm (BxHxT) 0.7 x 39.4 x 0.1 inch (WxHxD)
Weight	481 g (1.1 lbs)

Rubber tape SKB 19 9M SW

Part no.: 922829

Roll with 9 m self-bonding rubber tape to be wrapped around constant force springs for permanent corrosion protection.



Technical specifications

Color	black
Weight	167 g (0.4 lbs)



System accessories

Overvoltage protection – EMC, accessories

Terminal - pin connection STAK 2X16

Part no.: 922777

Pin-shaped terminal for EMC-optimized series connection of lightning current and surge arresters according to IEC 60364-5-53.

Technical specifications

Lightning impulse current (10/350 µs)	25 kA
Min. cross-sectional area	2x 1.5 mm ²
Max. cross-sectional area	2x max. 16 mm ² (
Connection	Front (double terminal)
Weight	20 g (0.04 lbs)

Gas discharge tube GDT 230 B3 FSD

Part no.: 922788

High-capacity replacement gas discharge tube for DRL 10 or BM 10 DRL. Three-pole version with common arcing chamber for a constant voltage protection level line-line and line-ground.

Note

Inserted in Plug-in SPD block DRL 10 B 180 FSD 922789

Technical specifications

Visual fault indication	yes
Fail-safe-spring	yes
Weight	2 g (0.07 oz)

Label holder SR DRL

Part no.: 922792

Universal label holder made of stainless steel for clear identification of LSA connections. Can be snapped onto LSA plug-in SPD blocks, earthing frames with protective plugs or mounting frames with LSA blocks of the 2/10 series.

Technical specifications

Material	stainless steel
Weight	16 g (0.04 lbs)

Product features:

- Universal label holder for labelling surge protective devices or LSA blocks
- Break-proof support made of corrosion-resistant stainless steel
- Label insert allows easy replacement

Note

Insertable in:

Plug-in SPD block DRL 10 B 180 FSD	922789
Earthing frame EF 10 DRL	922793
Disconnection block TL2 10DA LSA	922798



System accessories

Overvoltage protection – EMC, accessories

Earthing frame EF 10 DRL

**Part no.: 922793**

Snap-on earthing frame for earthing and installation of max. 10 DRL protective plugs. DRL RD 48, part no. 922790. Plugs into a 10-pair disconnection block or Plug-in SPD block DRL 10 B 180 FSD, part no. 922789.

Product features:

- Low protection level wire/wire for terminal protection
- Energetically coordinated to DRL plug-in magazine
- Can be used according to the lightning protection zone concept at interfaces 1 - 2 and higher

Technical specifications

Material	Polyamide 6.6, yellow
Dimensions	113 x 22 x 26 mm (BxLxH) 4.5 x 0.9 x 1.0 inch
Weight	10 g (0.02 lbs)

Disconnection block TL2 10DA LSA

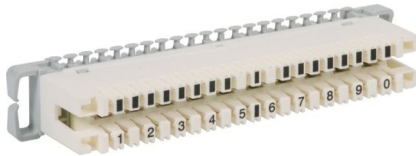
**Part no.: 922798**

Series 2 for LSA connection technology for connecting 10 pairs each on the cable and routing side. By inserting DRL components, the protection between the isolating contacts is established.

Technical specifications

Enclosure material	PBT
Contact material	Special brass
Contact surface	Silver
Test method	DIN 47608-1, -2
Diameter of solid conductors	0.4 - 0.8 mm
Diameter of conductor with insulation	0.7 - 1.5 mm
Electric strength	2 kV / 50 Hz
Weight	60 g



System accessories

Overvoltage protection – EMC, accessories

Partition TW DRC MCM EX



Product features:

- Allows non-intrinsically safe circuits to be placed directly next to Ex i circuits (space gain)
- Increase of the thread measure to ≥ 50 mm in accordance with EN 60079-11
- Suitable for mounting rails with a height of 7.5 mm and 15 mm
- Easy installation by simply snapping the partition onto a mounting rail

Technical specifications

Material	Polyamide PA 6.6, blue
Dimensions	2.5 x 137 x 91 mm (BxHxT) 0.1 x 5.4 x 3.6 inch (WxHxD)
Weight	31 g (0.07 lbs)

Part no.: 922806

Certain conditions must be fulfilled when installing BLITZ-DUCTOR XT Ex (i) surge protective devices in intrinsically safe circuits.

In accordance with EN 60079-11;2007 a minimum distance (thread measure) of ≥ 50 mm must be maintained between intrinsically and non-intrinsically safe circuits (connecting parts, e.g. terminals)!

When using the Ex i partition of type TW DRC MCM EX, this distance is also maintained if the surge protective devices are arranged directly next to one other.

Ideally suited for use in conjunction with DRC MCM XT for condition monitoring of BXT modules.

Note

Mounting on 35 mm DIN rails according to EN 60715.



System accessories

Overvoltage protection – EMC, accessories

Constant force spring SA KRF 10 V2A

**Part no.: 922830**

Constant force springs allow solderless shield connections for equipotential bonding or lightning equipotential bonding. They can be installed subsequently without interrupting the cable shield or requiring tools for installation. Approved for nuclear installations according to TÜV Certificate No. T12-04-ETL003.

Technical specifications

Lightning impulse current (10/350 µs)	10 kA
Clamping range (Rd)	4 to 10 mm 0.2 to 0.4 inch
Material	stainless steel
Weight	2 g

Product features

- For solderless connection of a conductor on the shield
- Suitable for all plastic and lead sheathed cables
- Also for steel-reinforced lead sheath cables

Note

Mounting on cable shield

Approvals / marking

T12-04-ETL003

Constant force spring SA KRF 15 V2A

Part no.: 922835

Technical specifications

Lightning impulse current (10/350 µs)	10 kA
Clamping range (Rd)	9 to 15 mm 0.4 to 0.6 inch
Material	stainless steel
Weight	2 g

Otherwise like part no.: 922830

Constant force spring SA KRF 22 V2A

Part no.: 922836

Technical specifications

Lightning impulse current (10/350 µs)	10 kA
Clamping range (Rd)	14 to 22 mm 0.6 to 0.9 inch
Material	stainless steel
Weight	5 g (0.01 lbs)

Otherwise like part no. 922830

Constant force spring SA KRF 29 V2A

Part no.: 922837

Technical specifications

Lightning impulse current (10/350 µs)	10 kA
Clamping range (Rd)	18.5 to 29 mm 0.7 to 1.1 inch
Material	stainless steel
Weight	7 g (0.02 lbs)

Otherwise like part no. 922830



Accessories

Overvoltage protection - EMC, accessories

Overvoltage protection - Base BXT BAS



Product features:

- Four-pole version for universal use with all types of BSP and BXT / BXTU protection modules
- No signal interruption if the protection module is removed
- Universal design without protection elements

Technical specifications

Operating temperature	- 40 °C to + 80 °C (-40 °F to +176 °F)
IP rating	IP 20
Cross-sectional area solid	0.08 - 4 mm ²
Cross-sectional area flexible	0.08 - 2.5 mm ²
Material	Polyamide PA 6.6, yellow
Weight	34 g (0.07 lbs)
Dimensions	12 x 90 x 50 mm (BxHxT) 0.07 x 3.5 x 2.0 inch (WxHxD)



Part no.: 922843

The Overvoltage protection base part is an extremely space-saving and universal four-pole feed-through terminal for the insertion of a protection module without signal disconnection if the protection module is removed. The snap-in mechanism at the supporting foot of the base part allows the protection module to be safely earthed via the DIN rail. Since no components of the protective circuit are situated in the base part, maintenance operation is only required for the protection modules.

Note

- Mounting on 35 mm DIN rails acc. to EN 60715
- Earthing via DIN rails acc. to EN 60715
- Connection (input/output) via screw clamp

Circuit diagram

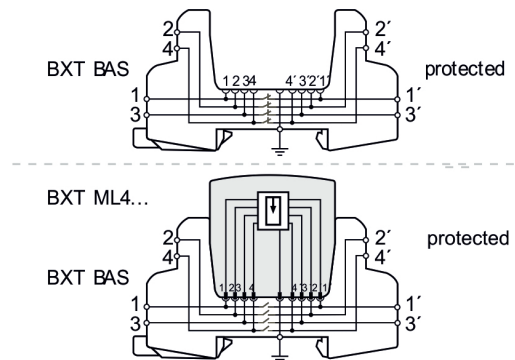

Approvals / marking*

Ex-conformity acc. to 2014/34/EU: Ex II 3 G Ex nA IIC T4 Gc
 Type examination certificate: DEKRA 11ATEX0089 X
 IECEx Certificate of conformity: IECEx DEK 11.0032X
 * only in connection with an approved protection module

Overvoltage protection - Base BXT BAS



Material

Polyamide PA 6.6, blue

Part no.: 922844

Approvals / marking*

Ex-conformity acc. to 2014/34/EU:
 Ex II 2(1) G Ex ia [ia Ga] IIC T4...T6 Gb
 Ex II 2 GEx ib II C T4...T6 Gb

Type examination certificate: KEMA 06ATEX0274 X
 IECEx Certificate of conformity: IECEx DEK 11.0078X

* only in connection with an approved protection module

Otherwise like part no.: 922843



Accessories

Overvoltage protection - EMC, accessories

Terminal - shield contact SAK BXT LR

Part no.: 922856

Two spring terminals for permanent low-impedance shield contact with the protected and unprotected side of a XT / XTU / SP arrester. With integrated coding for direct or indirect shield earthing. Cable ties and insulating strips are included. Suitable for BXT(U) ML2 ...S ... / BSP M2 ... types (only direct shield earthing).

Technical specifications

Clamping range	3 to 10 mm
Weight	12 g (0.03 lbs)

Included in delivery

2 x Terminal - shield contact SAK BXT LR
Cable tie
insulating strips

Terminal - shield contact STAK 25

Part no.: 922879

Allows series connection (connection of two conductors) of surge protective devices up to 25 mm².
Allows EMC-optimized feed-through wiring according to DIN VDE 0100-534.

Technical specification

Rated current AC/DC (U_N)	600 V
Rated load current AC (I_L)	100 A
Lightning impulse current (10/350 μ s)	25 kA
Weight	17 g (0.04 lbs)
Dimensions	18 x 46 x 35 mm (BxHxT) 0.7 x 1.8 x 1.4 inch

Spare LifeCheck[®]-Sensor LCS DRC BXT

Part no.: 922883

LifeCheck[®]-Sensor and test module as spare part for portable LifeCheck[®] dest device part no. 922802.

Technical specifications

Weight	64 g (0.14 lbs)
--------	-----------------

Quick labeling system BS BA1 BA15 BXT

Part no.: 922858

Technical specifications

Color	transparent
Weight	6 g (0.01 lbs)
Dimensions	13 x 7 mm (BxH) 0.5 x 0.3 inch (WxH)

2 x 165 adhesive labels for labeling DRC MCM XT monitoring devices with their bus address.



Accessories

Overvoltage protection - EMC, accessories

Overvoltage protection DV MOD NPE 50



Part no.: 922868

50 kA-N-PE spark-gap-based protection module for Overvoltage protection M.. with „...+1“ circuit part no. 922869.

Easy replacement of protection modules without tools due to module locking system with module release button.

Technical specifications

Max. continuous operating AC	255 V
Lightning current (10/350 µs)	50 kA
IP rating	IP 20
Weight	171 g (0.4 lbs)
Dimensions	36 x 45 x 62 mm (BxHxT) 1.4 x 1.7 x 2.4 inch (WxHxD)

Circuit diagram

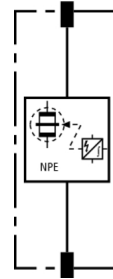

Overvoltage protection DV MOD 255



Part no.: 922867

Spark-gap-based protection module for DV M part no. 922869.

Technical specifications

Max. continuous operating AC	264 V
Lightning current (10/350 µs)	25 kA
IP rating	IP 20
Weight	192 g (0.4 lbs)
Dimensions	36 x 45 x 62 mm (BxHxT) 1.4 x 1.7 x 2.4 inch (WxHxD)



Accessories

Overvoltage protection - EMC, accessories

Overvoltage protection DG MOD 275



Part no.: 922870

Varistor protection module for Overvoltage protection DG M and DG S ...

part no. 922874, 922875, 922876, 922877, 922878.

Technical specifications

Nominal discharge current (8/20 μ s)	20 kA
Max. discharge current (8/20 μ s)	40 kA
Max. continuous operating AC	275 V
Weight	43 g (0.09 lbs)
Dimensions	18 x 45 x 51 mm (BxHxT) 0.7 x 1.8 x 2.0 inch (WxHxD)

Otherwise like part no. 922868

Circuit diagram

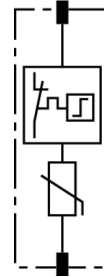

Overvoltage protection DG MOD 320



Part no.: 922871

Varistor protection module for Overvoltage protection DG M and DG S ...

part no. 922874, 922875, 922876, 922877, 922878.

Technical specifications

Nom. discharge current (8/20 μ s)	20 kA
Max. discharge current (8/20 μ s)	40 kA
Max. continuous operating AC	320 V
Weight	46 g (0.1 lbs)
Dimensions	18 x 45 x 51 mm (BxHxT) 0.7 x 1.8 x 2.0 inch (WxHxD)

Otherwise like part no. 922868

Circuit diagram

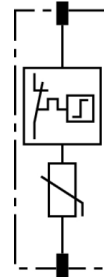



Accessories

Overvoltage protection - EMC, accessories

Overvoltage protection DG MOD NPE



Technical specifications

Nom. discharge current (8/20 μ s)	20 kA
Max. discharge current (8/20 μ s)	40 kA
Max. continuous operating AC	255 V
Weight	38 g (0.08 lbs)
Dimensions	18 x 45 x 51 mm (BxHxT) 0.7 x 1.8 x 2.0 inch (WxHxD)

Part no.: 922872

N-PE spark-gap-based protection module for two-pole and four-pole DG M TT part no. 922875, 922876.

Otherwise like part no. 922868

Circuit diagram

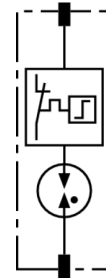

Overvoltage protection DR MOD 255



Technical specifications

Nom. discharge current (8/20 μ s)	3 kA
Max. discharge current (8/20 μ s)	5 kA
Max. continuous operating AC	255 V
Weight	28 g (0.06 lbs)
Dimensions	18 x 45 x 51 mm (BxHxT) 0.7 x 1.8 x 2.0 inch (WxHxD)

Part no.: 922880

Protection module with integrated Y protection circuit for surge arrester DR M 2P 255 FM part no. 922882.

Otherwise like part no. 922868

Circuit diagram

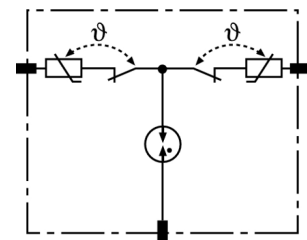



Manual call points

Chapter 05



Manual call points

DMX indoor application

Overview indoor application

Application Accessories Replacement	Application								Accessories							Replacement						
	IP rating	Short circuit isolator	Ex Zone	Approvals/ Norms (further approval on catalogue page)	Alarm-LED	Latching contact (R) Non-Latching contact (T)	Conventional (G) Addressable (A)	Silicone-free	Weatherproof enclosure red	Weatherproof enclosure yellow	Weatherproof enclosure blue	Weatherproof enclosure green	Special labeling for outside sign	French labeling	Individual labeling	Detector element (inlay) DMX Symbol (904449)	Detector element (inlay) DMX Symbol LED (904450)	Board DMX3000 (907764)	Board DMX3000, LED (907765)	Board DMX3000, 2GRU (907766)	Board DMX3000, LED ext. (907728)	Board DMX95-1 (916383)
4004724 HME/3000/17/H1/04 Manual Call Point, red	IP 43	---	---	VdS EN 54-11	X	R	G	---	X	---	---	---	---	---	---	---	---	---	---	---	---	---
4004718 HME/3000/32/H1/04 Manual Call Point, red	IP 43	X	---	VdS EN 54-11 EN 54-17	X	R	A	---	X	---	---	---	---	---	---	---	---	---	---	---	---	---
903767 DMX3000 Ex Manual Call Point, red	IP 42	---	1 22	VdS EN 54-11 ATEX	---	R	G	---	X	---	---	---	X ¹	X ¹	---	X	---	---	---	---	---	---
923164 DMX SA 908-I Manual call point, red	IP 44	---	---	EN 54-11 EN 54-17	X	---	A	---	---	---	---	---	---	---	---	---	---	---	---	---	---	---
4004725 HME/1021/17/17/04 Manual Release, yellow	IP 43	---	---	VdS EN 12094-3	X	R	G	---	---	X	---	---	---	---	X	---	---	---	---	---	---	---
4004719 HME/1021/32/17/04 Manual Release, yellow	IP 43	---	---	VdS EN 12094-3 EN 54-17	X	R	A	---	---	X	---	---	---	---	---	---	---	---	---	---	---	---
903770 DMX3000 Ex Manual Release, yellow	IP 42	---	1 22	VdS EN 12094-3 ATEX	---	R	G	---	---	X	---	---	X ¹	X ¹	---	X	---	---	---	---	---	---
923165 DMX SA 908-I Manual Call Point, yellow	IP 44	---	---	EN 54-11 EN 54-17	X	---	A	---	---	---	---	---	---	---	---	---	---	---	---	---	---	---
4004722 HME/5015/17/18/04 Emergency Button, blue	IP 43	X	---	VdS EN 12094-3	---	T	G	---	---	---	X	---	---	---	---	---	---	---	---	---	---	---
4004722 HME/5015/32/18/04 Emergency Button, blue	IP 43	---	---	VdS EN 12094-3 EN 54-17	X	T	A	---	---	---	X	---	---	---	---	---	---	---	---	---	---	---
4004721 HME/5015/32/02/04 Internal alarm, blue	IP 43	X	---	---	X	R	A	---	---	---	X	---	---	---	---	---	---	---	---	---	---	---
903769 DMX3000 Ex Emergency Button, blue	IP 42	---	1 22	VdS EN 12094-3 ATEX	---	T	G	---	---	---	X	---	X ¹	X ¹	---	X	---	---	---	---	---	---
923166 DMX SA 908-I Manual Call Point, blue	IP 44	---	---	EN 54-11 EN 54-17	X	---	A	---	---	---	---	---	---	---	---	---	---	---	---	---	---	---
4004727 HME/6002/17/19/04 2nd Release, green	IP 43	---	---	VdS EN 12094-3	---	T	G	---	---	---	---	X	---	---	---	---	---	---	---	---	---	---
4004720 HME/6002/32/19/04 2nd Release, green	IP 43	X	---	VdS EN 12094-3 EN 54-17	X	T	A	---	---	---	---	X	---	---	---	---	---	---	---	---	---	---
903768 DMX3000 Ex 2nd Release, green	IP 42	---	1 22	VdS EN 12094-3 ATEX	---	T	G	---	---	---	---	X	---	---	---	X	---	---	---	---	---	---
903246 DMX3000 Manual Call Point, variable	IP 42	---	---	X ²	AA	R / T	G	AA	X ²	X ²	X ²	X ²	X ^{1,2}	X ^{1,2}	X	X ²	X ²	X ²	X ²	X ²	X ²	---
915750 DMX95-1 Manual Call Point, variable	IP 43	X	---	X ²	AA	R / T	A	AA	X ²	X ²	X ²	X ²	---	---	X	---	X	---	---	---	---	X
904152 DMX3000 Ex Manual Call Point, variable	IP 42	---	1 22	ATEX X ²	---	R / T	G	AA	X ²	X ²	X ²	X ²	X ¹	X ¹	X	X	---	---	---	---	---	---

X¹ = Manual Call Point is perhaps not approval compliant

X² = Depending on the variable type of detector

AA = On request



Manual call points

DMX indoor application, addressable

HME/3000/32/H1/04 Manual call point, red



Part no.: 4004718

Analog addressable manual call point for indoor areas, in accordance with EN 54-11 or EN 54-17. An additional weatherproof enclosure with seal set is separately available. Applicable for operation in fire alarm panels with XP95 protocol. Addressing via push button, the address can also be modified after installation. Markings or labels which do not comply with the standard will void the VdS and EN 54-11 approvals.

Technical specifications

Function	Type B, latching contact
Technic / protocol	XP95
Integrated short circuit insulator	yes
Number of detectors per loop for mixed automatic and manual	max. 126 units.
Operating voltage	18 - 28 V DC
Operating current	typ. 180 µA
Alarm current	3.5 mA
Alarm display	1 LED, red
IP rating with Protection kit	IP43 IP54
Enclosure material	Diecast aluminum
Color	red, similar RAL 3000
Operating temperature	-20 °C to +60 °C (-4 °F to +140 °F)
Relative humidity	5 to 95% no condensation
Specification acc. to	EN 54-11, EN 54-17
Weight	420 g (0.93 lbs)
Dimensions	126 x 126 x 35 mm (WxHxD) 5.0 x 5.0 x 1.4 inch (WxHxD)
Cable entries: on top / bottom back side	2 x M20x1.5 2 x 24x10 mm (0.4 inch)

Included in delivery

1 Paper inlay „Out of order“

Not included in delivery

Mounting hardware
Battery cable 917329
Monobloc battery 9 V

Connecting / mounting

Connecting cable 2-wire
Recommended cable, standard 747180
J-Y(ST)Y-2x2x0,8 mm
Recommended cable for circuit integrity 907940
JE-H(ST)H E30 2x2x0,8 mm
Conductor cross-section max. 2.5 mm² (AWG 13)
Electrostatic shielding not required

Optional accessories

Weatherproof enclosure red 4004909
Protection kit HME to IP54 4004915
Door key HME (PU=10 pcs.) 4004913
Glass sheet HME (PU=10 pcs.) 4004914

Note

The product has an integrated short circuit isolator. To set the address the manual call point has to be powered. The power supply can either be realized by connecting the device to the loop or by using a battery cable, part no. 917329, and a common 9 V monobloc battery.

Approvals / marking



G 218056



0786-CPR-21600



Manual call points

DMX indoor application, addressable

HME/1021/32/17/04 Manual release, yellow



Part no.: 4004719

Analog addressable manual call point for indoor areas, in accordance with EN 12094-3 and EN 54-17. An additional weatherproof enclosure with seal set is separately available. Applicable for operation in fire alarm panels with XP95 protocol. Addressing via push button, the address can also be modified after installation. Labeling front: „HANDAUSLÖSUNG-Gaslöschanlage“. Back side: „HANDAUSLÖSUNG-Feuerlöschanlage“. Markings or labels which do not comply with the standard will void the VdS and EN 12094-3 approvals.

Technical specifications

Function	Type B, latching contact
Technic / protocol	XP95
Integrated short circuit insulator	yes
Number of detectors per loop for mixed automatic and manual	max. 126 units.
Operating voltage	18 - 28 V DC
Operating current	typ. 180 µA
Alarm current	3.5 mA
Alarm display	1 LED, red
IP rating with Protection kit	IP43 IP54
Enclosure material	Diecast aluminum
Color	yellow, similar RAL 1021
Operating temperature	-20 °C to +60 °C (-4 °F to +140 °F)
Relative humidity	5 to 95% no condensation
Specification acc. to	EN 12094-3, EN 54-17
Weight	420 g (0.93 lbs)
Dimensions	126 x 126 x 35 mm (WxHxD) 5.0 x 5.0 x 1.4 inch (WxHxD)
Cable entries: on top / bottom back side	2 x M20x1.5 2 x 24x10 mm (0.4 inch)

Included in delivery

1 Paper inlay „Out of order“
Sign sheet multilingual (EN, IT, FR, ES, PT, PL)

Not included in delivery

Mounting hardware
Battery cable 917329
Monobloc battery 9 V

Connecting / mounting

Connecting cable 2-wire
Recommended cable, standard 747180
J-Y(ST)Y-2x2x0,8 mm
Recommended cable for circuit integrity 907940
JE-H(ST)H E30 2x2x0,8 mm
Conductor cross-section max. 2.5 mm² (AWG 13)
Electrostatic shielding not required

Optional accessories

Weatherproof enclosure yellow 4004911
Protection kit HME to IP54 4004915
Door key HME (PU=10 pcs.) 4004913
Glass sheet HME (PU=10 pcs.) 4004914

Note

The product has an integrated short circuit isolator. To set the address the manual call point has to be powered. The power supply can either be realized by connecting the device to the loop or by using a battery cable, part no. 917329, and a common 9 V monobloc battery.

Approvals / marking



G 218057



0786-CPR-21601



Manual call points

DMX indoor application, addressable

HME/6002/32/19/04 2nd release, green**Part no.: 4004720**

Analog addressable manual call point for indoor areas, in accordance with VdS 2496 and EN 54-17. An additional weatherproof enclosure with seal set is separately available. Applicable for operation in fire alarm panels with XP95 protocol. Addressing via push button, the address can also be modified after installation. Labeling front: „NACHFLUTEN-Gaslöschanlage“. Back side: „NACHFLUTEN“. Markings or labels which do not comply with the standard will void the VdS approval.

Technical specifications

Function	Type B, non-latching contact
Technic / protocol	XP95
Integrated short circuit insulator	yes
Number of detectors per loop for mixed automatic and manual	max. 126 units
Operating voltage	18 - 28 V DC
Operating current	typ. 180 µA
Alarm current	3.5 mA
Alarm display	1 LED, red
IP rating with Protection kit	IP43 IP54
Enclosure material	Diecast aluminum
Color	green, similar RAL 6002
Operating temperature	-20 °C to +60 °C (-4 °F to +140 °F)
Relative humidity	5 to 95% no condensation
Specification acc. to	VdS 2496, EN 54-17
Weight	420 g (0.93 lbs)
Dimensions	126 x 126 x 35 mm (WxHxD) 5.0 x 5.0 x 1.4 inch (WxHxD)
Cable entries: on top / bottom back side	2 x M20x1.5 2 x 24x10 mm (0.4 inch)

Included in delivery

1 Paper inlay „Out of order“

Not included in delivery

Mounting hardware
Battery cable 917329
Monobloc battery 9 V

Connecting / mounting

Connecting cable 2-wire
Recommended cable, standard 747180
J-Y(ST)Y-2x2x0,8 mm
Recommended cable for circuit integrity 907940
JE-H(ST)H E30 2x2x0,8 mm
Conductor cross-section max. 2.5 mm² (AWG 13)
Electrostatic shielding not required

Optional accessories

Weatherproof enclosure green 4004912
Protection kit HME to IP54 4004915
Door key HME (PU=10 pcs.) 4004913
Glass sheet HME (PU=10 pcs.) 4004914

Note

The product has an integrated short circuit isolator. To set the address the manual call point has to be powered. The power supply can either be realized by connecting the device to the loop or by using a battery cable, part no. 917329, and a common 9 V monobloc battery.

Approvals / marking



G 218058





Manual call points

DMX indoor application, addressable

HME/5015/32/02/04 Internal alarm, blue



Part no.: 4004721

Analog addressable manual call point for indoor areas, in accordance with EN 54-17. An additional weatherproof enclosure with seal set is separately available. Applicable for operation in fire alarm panels with XP95 protocol. Addressing via push button, the address can also be modified after installation. Labeling front: „HAUSALARM“ (on white ground). Back side: „HAUSALARM“ (on blue ground). Markings or labels which do not comply with the standard will void the VdS and EN 12094-3 approvals.

Technical specifications

Function	Type B, latching contact
Technic / protocol	XP95
Integrated short circuit insulator	yes
Number of detectors per loop for mixed automatic and manual	max. 126 units.
Operating voltage	18 - 28 V DC
Operating current	typ. 180 µA
Alarm current	3.5 mA
Alarm display	1 LED, red
IP rating with Protection kit	IP43 IP54
Enclosure material	Diecast aluminum
Color	blue, similar RAL 5015
Operating temperature	-20 °C to +60 °C (-4 °F to +140 °F)
Relative humidity	5 to 95% no condensation
Specification acc. to	EN 54-17
Weight	420 g (0.93 lbs)
Dimensions	126 x 126 x 35 mm (WxHxD) 5.0 x 5.0 x 1.4 inch (WxHxD)
Cable entries: on top / bottom back side	2 x M20x1.5 2 x 24x10 mm (0.4 inch)

Included in delivery

1 Paper inlay „Out of order“

Not included in delivery

Mounting hardware
Battery cable 917329
Monobloc battery 9 V

Connecting / mounting

Connecting cable 2-wire
Recommended cable, standard 747180
J-Y(ST)Y-2x2x0,8 mm
Recommended cable for circuit integrity 907940
JE-H(ST)H E30 2x2x0,8 mm
Conductor cross-section max. 2.5 mm² (AWG 13)
Electrostatic shielding not required

Optional accessories

Weatherproof enclosure blue 4004910
Protection kit HME to IP54 4004915
Door key HME (PU=10 pcs.) 4004913
Glass sheet HME (PU=10 pcs.) 4004914

Note

The product has an integrated short circuit isolator. To set the address the manual call point has to be powered. The power supply can either be realized by connecting the device to the loop or by using a battery cable, part no. 917329, and a common 9 V monobloc battery.

Approvals / marking





Manual call points

DMX indoor application, addressable

HME/5015/32/18/04 Emergency button, blue



Technical specifications

Function	Type B, non-latching contact
Technic / protocol	XP95
Integrated short circuit insulator	yes
Number of detectors per loop for mixed automatic and manual	max. 20 units.
Operating voltage	18 - 28 V DC
Operating current	typ. 180 µA
Alarm current	3.5 mA
Alarm display	1 LED, red
IP rating with Protection kit	IP43 IP54
Enclosure material	Diecast aluminum
Color	blue, similar RAL 5015
Operating temperature	-20 °C to +60 °C (-4 °F to +140 °F)
Relative humidity	5 to 95% no condensation
Specification acc. to	EN 12094-3, EN 54-17
Weight	420 g (0.93 lbs)
Dimensions	126 x 126 x 35 mm (WxHxD) 5.0 x 5.0 x 1.4 inch (WxHxD)
Cable entries: on top / bottom back side	2 x M20x1.5 2 x 24x10 mm (0.4 inch)

Part no.: 4004722

Analog addressable manual call point for indoor areas, in accordance with EN 12094-3 and EN 54-17. An additional weatherproof enclosure with seal set is separately available. Applicable for operation in fire alarm panels with XP95 protocol. Addressing via push button, the address can also be modified after installation. Labeling front: „STOPP-TASTER Gaslöschanlagen“. Back side: „Stopp-Taster Feuerlöschanlage“. Markings or labels which do not comply with the standard will void the VdS and EN 12094-3 approvals.

Attention

For the use of these detectors in conformity with standards with Clunid control panels in accordance with EN 12094 the maximum number of detectors per loop is reduced to 20 units.

Included in delivery

1 Paper inlay „Out of order“

Not included in delivery

Mounting hardware
Battery cable 917329
Monobloc battery 9 V

Connecting / mounting

Connecting cable 2-wire
Recommended cable, standard 747180
J-Y(ST)Y-2x2x0,8 mm
Recommended cable for circuit integrity 907940
JE-H(ST)H E30 2x2x0,8 mm
Conductor cross-section max. 2.5 mm² (AWG 13)
Electrostatic shielding not required

Optional accessories

Weatherproof enclosure blue 4004910
Protection kit HME to IP54 4004915
Door key HME (PU=10 pcs.) 4004913
Glass sheet HME (PU=10 pcs.) 4004914

Note

The product has an integrated short circuit isolator. To set the address the manual call point has to be powered. The power supply can either be realized by connecting the device to the loop or by using a battery cable, part no. 917329, and a common 9 V monobloc battery.

Approvals / marking



G 218058



0786-CPR-21602



Manual call points

DMX indoor application, addressable

DMX95-I manual call point, variable

Part no.: 915750



Technical specifications

Function	Type B, latching or non-latching contact
Technology / protocol	Loop AP / XP95
Integrated short circuit isolator	yes
No. of detectors per loop for mixed automatic and manual	max. 126 units
Operating voltage	17 V - 28 V DC
Operating current	240 µA
Alarm current	3.7 mA
Alarm indication	1 red LED
IP rating (EN 60529) with weatherproof enclosure	IP 43 IP 54
Enclosure material	Diecast aluminum
Color	RAL 3001, red RAL 1021, yellow RAL 5015, blue RAL 6002, green
Trigger mechanism material	PC
Operating temperature	-20 °C to +60 °C (-4 °F to +140 °F)
Relative humidity	5 to 95% no condensation
Specification according to	similar to EN 54-11, EN 12094-3 or EN 54-17
Weight	approx. 400 g (0.9 lbs)
Dimensions	125 x 125 x 32.5 mm (WxHxD) 4.9 x 4.9 x 1.3 inch (WxHxD)

Note

The product has an integrated short circuit isolator. To set the address the manual call point has to be powered. The power supply can either be realized by connecting the device to the loop or by using a battery cable (part no. 917329) and a common 9 V monobloc battery.

Analogue addressable manual call point for indoor areas, similar to EN 54-11 or EN 12094-3 or EN 54-17.

Free selection of the detector configuration possible (Latching or non-latching contact, silicone free, special labeling).

The order is placed along with an additional note on the detector, with order number and the desired modifications. Production is then performed manually. A contract review will be performed in order to comply with regulations. An additional weatherproof enclosure with seal set is separately available. Applicable for operation in fire alarm panels with Loop AP protocol. Addressing via push button; the address can also be modified after installation. Operating instructions and address information are included with the detector.

Included in delivery

Mounting hardware
2 Cable glands M20 x 1.5
1 Paper inlay "Out of order"

Not included in delivery

1 Door key design "D" 173881
Battery cable 917329
Monobloc battery 9 V

Connection / mounting

Connection cable 2-wire
Recommended cable, standard 747180
J-Y(ST)Y-2x2x0.8 mm
Recommended cable for circuit integrity 907940
JE-H(ST)H E30 2x2x0.8 mm
Conductor cross-section max. 1.5 mm² (AWG 15)
Electrostatic shielding not required

Approvals / marking





Manual call points

DMX indoor application, addressable

Manual call point DMX SA 908-I red



Technical specifications

Function	Type A, latching contact
Technology/protocol	Loop AP / XP95 / Discovery (CoreProtocol ¹⁾) (via DIP-schwitch)
Recommended protocol FMZ 5000/DCP-1	Discovery
Integrated short circuit isolator	yes
No. of detectors per loop for mixed automatic and manual	max. 126 units
Operating voltage	17 V - 35 V DC
Quiescent current	100 µA
Alarm current (incl. LED)	4 mA
Alarm indication	1 LED, red
IP rating (EN 60529)	IP 44
Enclosure material	Polycarbonate
Color	red
Operating temperature	-40 °C to + 70 °C (-40 °F to +158 °F)
Relative humidity (IEC 721-3-3)	max. 95% no condensation
Specification according to	EN 54-11 EN 54-17
Weight	approx. 180 g (0.40 lbs)
Dimensions	90 x 90 x 63 mm (WxHxD) 3.5 x 3.5 x 2.5 inch (WxHxD)

Part no.: 923164

Analog addressable manual call point with integrated dual-isolator for indoor areas, in accordance with EN 54-11 and EN54-17. Applicable for operation in fire alarm panels with Loop AP protocol (Discovery & XP95). Addressing via DIP switches. The address can also be modified after installation. Markings or labels which do not comply with the standard will void the EN 54-11 approval. Operating instructions and address information are included with the detector.

Included in delivery

1 key to reset / open the MCP,

Not included in delivery

Mounting hardware

Connection / mounting

Connection cable	2-wire
Recommended cable, standard J-Y(ST)Y-2x2x0.8 mm	747180
Recommended cable for circuit integrity JE-H(ST)H E30 2x2x0.8 mm	907940
Conductor cross-section	max. 2.5 mm ² (AWG 13)
Electrostatic shielding	not required

Note

Observe DIP switch position! Select and configure the communication protocol via the DIP switches.

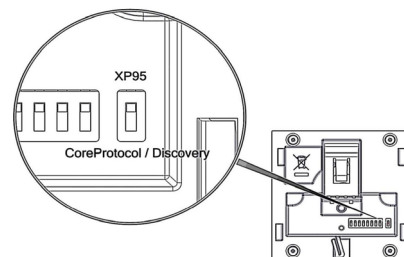

Approvals / marking



G 218007



2531-CPR-CSP11028
0832-CPR-F2054



Manual call points

DMX indoor application, addressable

DMX SA 904-I, yellow



Part no.: 923165

Color yellow, Apollo branding, has no certification according to EN 54-11 and EN 54-17.

Otherwise like part no. 923164.

Approvals / marking



DMX SA 905-I, blue



Part no.: 923166

Color blue, Apollo branding, has no certification according to EN 54-11 and EN 54-17.

Otherwise like part no. 923164.

Approvals / marking





Manual call points

DMX indoor application, addressable

DMX95-I manual call point CNBOP, red



Technical specifications

Function	Type B, latching contact
Technology / protocol	Loop AP / XP95
Integrated short circuit isolator	yes
No. of detectors per loop for mixed automatic and manual	max. 126 units
Operating voltage	17 V - 28 V DC
Operating current	240 µA
Alarm current	3.7 mA
Alarm indication	1 red LED
IP rating (EN 60529) with weatherproof enclosure	IP 43 IP 54
Enclosure material	Diecast aluminum
Color	RAL 3001, red
Trigger mechanism material	PC & PP
Operating temperature	-20 °C to +60 °C (-4 °F to +140 °F)
Relative humidity (IEC 721-3-3)	5 to 95% no condensation
Specification according to	EN 54-11
Weight	approx. 400 g (0.9 lbs)
Dimensions	125 x 125 x 32.5 mm (WxHxD) 4.9 x 4.9 x 1.3 inch (WxHxD)

Part no.: 923689

Analog addressable manual call point for indoor areas, in accordance with EN 54-11 or EN 54-17 and the national specification of CNBOP concerning Poland (inscription "Pożar"). An additional weatherproof enclosure with seal set is separately available. Applicable for operation in fire alarm panels with Loop AP protocol. Addressing via push button; the address can also be modified after installation. The white inside sign can be replaced with other labels (see DMX indoor application, accessories). Markings or labels which do not comply with the standard will void the VdS, EN 54-11 and CNBOP approvals. Operating instructions and address information are included with the detector.

Included in delivery

Mounting hardware
2 Cable glands M20 x 1.5
1 Paper inlay "Out of order"

Not included in delivery

1 Door key design "D" 173881
Battery cable 917329
Monobloc battery 9 V

Connection / mounting

Connection cable 2-wire
Recommended cable, standard 747180
J-Y(ST)Y-2x2x0.8 mm
Recommended cable for circuit integrity 907940
JE-H(ST)H E30 2x2x0.8 mm
Conductor cross-section max. 1.5 mm² (AWG 15)
Electrostatic shielding not required

Note

The product has an integrated short circuit isolator. To set the address the manual call point has to be powered. The power supply can either be realized by connecting the device to the loop or by using a battery cable (part no. 917329) and a common 9 V monobloc battery.

Approvals / marking



G 214084



0786-CPR-21396



3261/2018



Manual call points

Indoor application, conventional

HME/3000/17/H1/04 Manual call point, red



Part no.: 4004724

Conventional manual call point for indoor areas according to EN 54-11 and. An additional weatherproof enclosure with seal set is separately available. Applicable for operation on conventional lines.

Technical specifications

Function	Type B, latching contact
Technology	Conventional
Operating voltage	10 - 30 V DC
Alarm current	17 mA (at 10 V)
Alarm display	1 LED, red
IP rating with Protection kit	IP43 IP54
Enclosure material	Diecast aluminum
Color	red, similar RAL 3000
Operating temperature	-20 °C to +60 °C (-4 °F to +140 °F)
Relative humidity	5 to 95% no condensation
Specification acc. to	EN 54-11
Weight	420 g (0.93 lbs)
Dimensions	126 x 126 x 35 mm (WxHxD) 5.0 x 5.0 x 1.4 inch (WxHxD)
Cable entries: on top / bottom back side	2 x M20x1.5 2 x 24x10 mm (0.4 inch)

Not included in delivery

Mounting hardware

Connecting / mounting

Connecting cable	2-wire
Recommended cable, standard	747180
J-Y(ST)Y-2x2x0,8 mm	
Recommended cable for circuit integrity	907940
JE-H(ST)H E30 2x2x0,8 mm	
Conductor cross-section	max. 2.5 mm ² (AWG 13)
Electrostatic shielding	not required

Optional accessories

Weatherproof enclosure red	4004909
Protection kit HME to IP54	4004915
Door key HME (PU=10 pcs.)	4004913
Glass sheet HME (PU=10 pcs.)	4004914

Approvals / marking



G 218045



0786-CPR-21594



Manual call points

Indoor application, conventional

HME/1021/17/17/04 Manual release, yellow

Part no.: 4004725



Conventional manual call point for indoor areas according to EN 12094-3. An additional weatherproof housing is available separately for use in areas subject to weather conditions. Applicable for operation on conventional lines. Labeling in accordance with EN 12094-3. Markings or labels which do not comply with the standard will void the VdS and EN 12094-3 approvals.

Technical specifications

Function	Type B, latching contact
Technology	Conventional
Operating voltage	10 - 30 V DC
Alarm current	17 mA (at 10 V)
Alarm display	1 LED, red
IP rating with Protection kit	IP43 IP54
Enclosure material	Diecast aluminum
Color	yellow, similar RAL 1021
Operating temperature	-20 °C to +60 °C (-4 °F to +140 °F)
Relative humidity	5 to 95% no condensation
Specification acc. to	EN 12094-3
Weight	420 g (0.93 lbs)
Dimensions	126 x 126 x 35 mm (WxHxD) 5.0 x 5.0 x 1.4 inch (WxHxD)
Cable entries: on top / bottom back side	2 x M20x1.5 2 x 24x10 mm (0.4 inch)

Included in delivery

1 Paper inlay „Out of order“
Sign sheet multilingual (EN, IT, FR, ES, PT, PL)

Not included in delivery

Mounting hardware

Connecting / mounting

Connecting cable	2-wire
Recommended cable, standard J-Y(ST)Y-2x2x0,8 mm	747180
Recommended cable for circuit integrity JE-H(ST)H E30 2x2x0,8 mm	907940
Conductor cross-section	max. 2.5 mm ² (AWG 13)
Electrostatic shielding	not required

Optional accessories

Weatherproof enclosure yellow	4004911
Protection kit HME to IP54	4004915
Door key HME (PU=10 pcs.)	4004913
Glass sheet HME (PU=10 pcs.)	4004914

Approvals / marking



G 218046



0786-CPR-21595



Manual call points

Indoor application, conventional

HME/5015/17/18/04 Emergency button, blue

Part no.: 4004726

Conventional manual call point for indoor areas according to EN 12094-3. An additional weatherproof housing is available separately for use in areas subject to weather conditions. Applicable for operation on conventional lines. Front labeling: „STOPP-TASTER Gaslöschanlage“. Back side: „STOPP-TASTER Feuerlöschanlage“. Markings or labels which do not comply with the standard will void the VdS and EN 12094-3 approvals.

Technical specifications

Function	Type B, non-latching contact
Technology	Conventional
Operating voltage	10 - 30 V DC
Alarm current	17 mA (at 10 V)
Alarm display	1 LED, red
IP rating with Protection kit	IP43 IP54
Enclosure material	Diecast aluminum
Color	blue, similar RAL 5015
Operating temperature	-20 °C to +60 °C (-4 °F to +140 °F)
Relative humidity	5 to 95% no condensation
Specification acc. to	EN 12094-3
Weight	420 g (0.93 lbs)
Dimensions	126 x 126 x 35 mm (WxHxD) 5.0 x 5.0 x 1.4 inch (WxHxD)
Cable entries: on top / bottom back side	2 x M20x1.5 2 x 24x10 mm (0.4 inch)

Not included in delivery

Mounting hardware

Connecting / mounting

Connecting cable	2-wire
Recommended cable, standard	747180
J-Y(ST)Y-2x2x0,8 mm	
Recommended cable for circuit integrity	907940
JE-H(ST)H E30 2x2x0,8 mm	
Conductor cross-section	max. 2.5 mm ² (AWG 13)
Electrostatic shielding	not required

Optional accessories

Weatherproof enclosure blue	4004910
Protection kit HME to IP54	4004915
Door key HME (PU=10 pcs.)	4004913
Glass sheet HME (PU=10 pcs.)	4004914

Approvals / markings



G 218047



0786-CPR-21596



Manual call points

Indoor application, conventional

HME/6002/17/19/04 2nd release, green



Part no.: 4004727

Conventional manual call point for indoor areas. An additional weatherproof housing is available separately for use in areas subject to weather conditions. Applicable for operation on conventional lines. Front labeling: „NACHFLUTEN Gaslöschanlage“. Back side: „NACHFLUTEN “. Markings or labels which do not comply with the standard will void the VdS approval.

Technical specifications

Function	Type B, non-latching contact
Technology	Conventional
Operating voltage	10 - 30 V DC
Alarm current	17 mA (at 10 V)
Alarm display	1 LED, red
IP rating with Protection kit	IP 43 IP 54
Enclosure material	Diecast aluminum
Color	green, similar RAL 6002
Operating temperature	-20 °C to +60 °C (-4 °F to +140 °F)
Relative humidity	5 to 95% no condensation
Specification acc. to	VdS 2496
Weight	420 g (0.93 lbs)
Dimensions	126 x 126 x 35 mm (WxHxD) 5.0 x 5.0 x 1.4 inch (WxHxD)
Cable entries: on top / bottom back side	2 x M20x1.5 2 x 24x10 mm (0.4 inch)

Not included in delivery

Mounting hardware

Connecting / mounting

Connecting cable	2-wire
Recommended cable, standard	747180
J-Y(ST)Y-2x2x0,8 mm	
Recommended cable for circuit integrity	907940
JE-H(ST)H E30 2x2x0,8 mm	
Conductor cross-section	max. 2.5 mm ² (AWG 13)
Electrostatic shielding	not required

Optional accessories

Weatherproof enclosure green	4004912
Protection kit HME to IP54	4004915
Door key HME (PU=10 pcs.)	4004913
Glass sheet HME (PU=10 pcs.)	4004914

Approvals / marking



G 218047





Manual call points

DMX indoor application, conventional

DMX3000 manual call point, variable

Part no.: 903246



Technical specifications

Function	Type B, latching or non-latching contact
Technology	Conventional
Rated voltage	9 V
Operating voltage	7.6 V - 13.2 V DC
Quiescent current	5 mA (at 9 V)
Alarm current	20 mA (at 9 V)
IP rating (EN 60529) with weatherproof enclosure	IP 42 IP 54
Enclosure material	Diecast aluminum
Color	RAL 3001, red RAL 1021, yellow RAL 5015, blue RAL 6002, green
Trigger mechanism material	PC
Operating temperature	-30 °C to +70 °C (-22 °F to +158 °F)
Relative humidity	0 to 95% no condensation
Specification according to	similar to EN 54-11 and EN 12094-3
Weight	approx. 500 g (1.1 lbs)
Dimensions	125 x 125 x 32.5 mm (WxHxD) 4.9 x 4.9 x 1.3 inch (WxHxD)

Conventional manual call point for indoor areas, similar to EN 54-11 or EN 12094-3.

Free selection of the detector configuration possible (Latching or non-latching contact, silicone free, special labeling). The order are placed with an additional note on the detector with part no. and the desired modifications. Production is then performed manually. A contract review will be performed in order to comply with regulations. An additional weatherproof enclosure with seal set is separately available. Applicable for operation on conventional lines. Operating instructions is included with the detector.

Included in delivery

- Mounting hardware
- 2 Cable glands M20 x 1.5
- 1 Paper inlay "Out of order"

Not included in delivery

- 1 Door key design "D" 173881

Connection / mounting

- Connection cable 2-wire
- Recommended cable, standard 747180
- J-Y(ST)Y-2x2x0.8 mm
- Recommended cable for circuit integrity 907940
- JE-H(ST)H E30 2x2x0.8 mm
- Conductor cross-section max. 2.5 mm² (AWG 13)
- Electrostatic shielding not required

Approvals / marking





Manual call points

DMX indoor application, conventional

DMX2000 LED manual call point, red

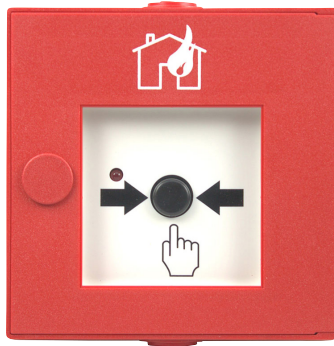

Technical specifications

Function	Type B, latching contact
Technology	Conventional
Rated voltage	9 V
Operating voltage	7.6 V - 13.2 V DC
Quiescent current	5 mA (at 9 V)
Alarm current	20 mA (at 9 V)
IP rating (EN 60529)	IP 42
Enclosure material	PC / ABS
Color	RAL 3000, red
Trigger mechanism material	PC
Operating temperature	-10 °C to +50 °C (14 °F to 122 °F)
Relative humidity	0 to 95% no condensation
Specification according to	EN 54-11
LED	lights up red when button is pressed
Weight	approx. 230 g (0.5 lbs)
Dimensions	135 x 135 x 35 mm (BxHxT) 5.3 x 5.3 x 1.4 inch (WxHxD)

Part no.: 920843

Conventional manual call point with red alarm indication (LED) for indoor areas, in accordance with EN 54-11. Applicable for operation on conventional lines. The printed symbol (burning house) and the white inside panel are designed in accordance with EN 54-11. Operating instructions and wiring notes are included with the detector.

Included in delivery

2 Blanking plugs M20 with membrane for cable feedthrough
1 Paper inlay "Out of order"
1 End of line-resistor 1,8 K (built-in)

Not included in delivery

Door key design "D" 173881
Mounting hardware

Connecting / mounting

Connecting cable 2-wire
Recommended cable, standard 747180
J-Y(ST)Y-2x2x0.8 mm
Recommended cable for circuit integrity 907940
JE-H(ST)H E30 2x2x0.8 mm
Conductor cross-section max. 2.5 mm² (AWG 13)
Electrostatic shielding not required

Approvals / marking





Manual call points

DMX indoor application, conventional



DMX2000 LED manual release, yellow

Part no.: 920844

Technical specifications

Function	Type B, latching contact
Color	RAL 1003, yellow
Specification according to	EN 12094-3

Otherwise like Part no. 920843

Included in delivery

English sign „MANUAL RELEASE Gas extinguishing system“ is included with the detector.

Approvals / marking





Manual call points

DMX indoor application, conventional

Pull station P32-1T



Product features

- Single pole, single throw (H/O) with a potential free contact for alarm
- For indoor use

Technical specifications

Function	Snap action switch
Contact Voltage	max. 30 V DC/1A
Enclosure material	Diecast enclosure
Colour	red
Specification according to	UL standard 38, 1999 Edition
LED	nonexistent
Weight	440 g (1.0 lbs)
Dimensions	80 x 119 x 22 mm (WxHxD) 3.2 x 4.7 x 0.9 inch (WxHxD)
Contact	1 NO contact1

Approvals / marking



Part no.: 918434

Pull station for indoor use.
The pull station is a „single action“ device. By pulling the white operating handle straight down the handle will lock into place and the contact is triggered.

Included in delivery

Pull station P32-1T
Mounting hardware
Key

Not included in delivery

Back Box
End of line-resistor (EOL)
Alarm resistor

Connecting / mounting

Connection cable 2-wire

Note

Applicable for operation at a conventional group of the fire detection and suppression control panel FMZ 5000 or Clunid. Distribution only to non-EU countries.

Connection diagram

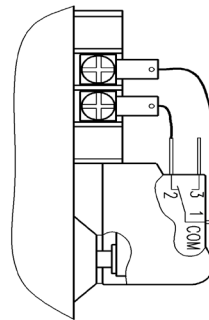



Manual call points

DMX indoor application, conventional

Abort switch CP-4410AS



Part no.: 918435

Abort switch for indoor use.
Single pole normally open contact (NO).

Included in delivery

Abort switch CP-4410AS
Mounting hardware

Not included in delivery

Back Box
End of line-resistor (EOL)
Alarm resistor

Technical specifications

Function	Non-latching contact
Contact Voltage	max. 24 V DC
Enclosure material	Stainless steel
Colour	Stainless steel finish
LED	non-existent
Weight	125 g (0.3 lbs)
Dimensions	114 x 114 x 51 mm (WxHxD) 4.5 x 4.5 x 2.0 inch (WxHxD)
Contact	1 NO contact

Connecting / mounting

Connection cable

2-wire

Note

Applicable for operation at a conventional group of fire alarm and suppression control panel FMZ 5000 or Clunid.
Distribution only to non-EU countries.

Connection diagram

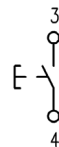

Approvals / marking





Manual call points

DMX indoor application, Ex

DMX3000 Ex manual call point, red



Technical specifications

Function	Type B, latching contact
Technology	Conventional
Rated voltage	9 V
Operating voltage	7.6 V - 13.2 V DC
Quiescent current	5 mA (at 9 V)
Alarm current	20 mA (at 9 V)
Effective inner capacity	$C_i = 12 \text{ nF}$
Effective inner inductance	$L_i = \text{negligible}$
IP rating (EN 60529) with weatherproof enclosure	IP 42 IP 54
Enclosure material	Diecast aluminum
Color	RAL 3001, red
Trigger mechanism material	PC
Operating temperature in temperature class T6	-25 °C to +40 °C (-13 °F to +104 °F)
Operating temperature in temperature class T4	-25 °C to +70 °C (-13 °F to +158 °F)
Relative humidity	0 to 95% no condensation
Specification according to	EN 54-11
Ex zone	Zone 1 (gas) and 22 (dust)
Weight	approx. 500 g (1.1 lbs)
Dimensions	125 x 125 x 32.5 mm (WxHxD) 4.9 x 4.9 x 1.3 inch (WxHxD)

Part no.: 903767

Conventional manual call point for indoor areas in Ex zone 1 or 22 in accordance with EN 54-11. An additional weatherproof enclosure with seal set is available. Applicable for operation on conventional lines. The printed symbol (house on fire) and the white inside panel are designed in accordance with EN 54-11. The white inside sign can be replaced with other labels (see DMX indoor application, accessories). Markings or labels which do not comply with the standard will void the VdS and EN 54-11 approvals. The Ex manual call point may only be used together with a safety barrier and a blue fire alarm cable. Operating instructions is included with the detector.

Included in delivery

Mounting hardware
2 Cable glands M20 x 1.5
1 Paper inlay "Out of order"

Not included in delivery

Safety barrier SBEx-9 933093
1 Door key design "D" 173881

Connection / mounting

Connection cable 2-wire
Conductor cross-section max. 2.5 mm² (AWG 13)
Electrostatic shielding not required

Note

The call point's metal casing is part of the local potential equalization.

Approvals / marking

Ex conformity in acc. with 2014/34/EU:

II 2G Ex ib IIC T6...T4 Gb

II 3D Ex ib IIIB T120°C Dc

Ex conformity Russia in acc. with TP TC 012/2011:

1Ex ia IIC T6/T4 Gb



G 297003



0786-CPD-20347





Manual call points

DMX indoor application, Ex



DMX3000 Ex manual release, yellow

Part no.: 903770

Technical specifications

Function	Type B, latching contact
Color	RAL 1021, yellow
Specification according to	EN 12094-3

Approvals / marking

Ex conformity in acc. with 2014/34/EU

⊕ II 2G Ex ib IIC T6...T4 Gb
 ⊕ II 3D Ex ib IIIB T120°C Dc

Markings or labels which do not comply with the standard will void the VdS and EN 12094-3 approvals.



Note

This MCP uses German labeling. For other languages please use part no. 904152

Otherwise like part no.: 903767

DMX3000 Ex emergency button, blue

Part no.: 903769

Technical specifications

Function	Type B, non-latching contact
Color	RAL 5015, blue
Specification according to	EN 12094-3

Approvals / marking

Ex conformity in acc. with 2014/34/EU

⊕ II 2G Ex ib IIC T6...T4 Gb
 ⊕ II 3D Ex ib IIIB T120°C Dc

Markings or labels which do not comply with the standard will void the VdS and EN 12094-3 approvals.



Note

This MCP uses German labeling. For other languages please use part no. 904152

Otherwise like part no.: 903767

DMX3000 Ex 2nd release, green

Part no.: 903768

Technical specifications

Function	Type B, non-latching contact
Color	RAL 6002, green
Specification according to	similar to EN 12094-3

Approvals / marking

Ex conformity in acc. with 2014/34/EU

⊕ II 2G Ex ib IIC T6...T4 Gb
 ⊕ II 3D Ex ib IIIB T120°C Dc

Markings or labels which do not comply with the standard will void the VdS approval.

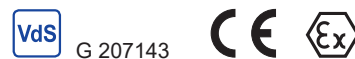

Note

This MCP uses German labeling. For other languages please use part no. 904152

Otherwise like part no.: 903767



Manual call points

DMX indoor application, Ex

DMX3000 SF Ex Robot Protection Manual Release, yellow

Technical specifications

Function	Type B, non-latching contact
Color	RAL 1021, yellow
Specification according to	similar to EN 12094-3 SF - silicone-free

Part no.: 921676

Approvals / marking

Ex conformity in acc. with 2014/34/EU:

⊕ II 2G Ex ib IIC T6...T4 Gb
⊕ II 3D Ex ib IIIB T120°C Dc



Otherwise like part no.: 903767



Manual call points

DMX indoor application, Ex

DMX3000 Ex manual call point, variable

Part no.: 904152



Technical specifications

Function	Type B, latching or non-latching contact
Technology	Conventional
Rated voltage	9 V
Operating voltage	7.6 V - 13.2 V DC
Quiescent current	5 mA (at 9 V)
Alarm current	20 mA (at 9 V)
Effective inner capacity	$C_i = 12 \text{ nF}$
Effective inner inductance	$L_i = \text{negligible}$
IP rating (EN 60529) with weatherproof enclosure	IP 42 IP 54
Enclosure material	Diecast aluminum
Color	RAL 3001, red RAL 1021, yellow RAL 5015, blue RAL 6002, green
Trigger mechanism material	PC
Operating temperature in temperature class T6	-25 °C to +40 °C (-13 °F to +104 °F)
Operating temperature in temperature class T4	-25 °C to +70 °C (-13 °F to +158 °F)
Relative humidity	0 to 95% no condensation
Specification according to	similar to EN 54-11 and EN 12094-3
Ex zone	Zone 1 (gas) and 22 (dust)
Weight	approx. 500 g (1.1 lbs)
Dimensions	125 x 125 x 32.5 mm (WxHxD) 4.9 x 4.9 x 1.3 inch (WxHxD)

Approvals / marking

Ex conformity in acc. with 2014/34/EU

II 2G Ex ib IIC T6...T4 Gb

II 3D Ex ib IIIB T120°C Dc

Ex conformity Russia in acc. with TP TC 012/2011:

1Ex ia IIC T6/T4 Gb



Conventional manual call point for indoor areas in Ex zone 1 or 22, similar to EN 54-11 or EN 12094-3.

Free selection of detector configuration possible (Latching or non-latching contact, silicone free, special labeling). The order is placed along with an additional note on the detector, with order number and the desired modifications. Production is then performed manually.

A contract review will be performed in order to comply with regulations. An additional weatherproof enclosure with seal set is available. Applicable for operation on conventional lines. The Ex manual call point may only be used together with a safety barrier and a blue fire alarm cable. Operating instructions is included with the detector.

Included in delivery

Mounting hardware
2 Cable glands M20 x 1.5
1 Paper inlay "Out of order"

Not included in delivery

Safety barrier SBEx-9 933093
1 Door key design "D" 173881

Connection / mounting

Connection cable 2-wire
Conductor cross-section max. 2.5 mm² (AWG 13)
Electrostatic shielding not required

Note

The call point's metal casing is part of the local potential equalization.



Manual call points

DMX indoor application, accessories

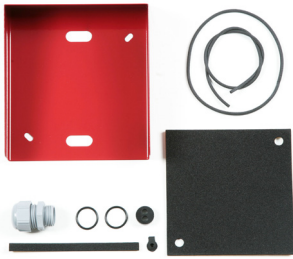

Weatherproof enclosure, red

Part no.: 903792

Technical specifications

With the weatherproof enclosure, the protection rating rises from IP42 to IP54 for the manual call points DMX3000, DMX3000 Ex, DMX95-I and DMX95.

Color	RAL 3001, red
Weight	0.28 kg (0.1 lbs)

Included in delivery

Weatherproof enclosure with seal set and gland M 20 x 1.5

Weatherproof enclosure, yellow

Part no.: 903779

Technical specifications

With the weatherproof enclosure, the protection rating rises from IP42 to IP54 for the manual call points DMX3000, DMX3000 Ex, DMX95-I and DMX95.

Color	RAL 1021, yellow
Weight	0.28 kg (0.1 lbs)

Included in delivery

Weatherproof enclosure with seal set and gland M 20 x 1.5

Weatherproof enclosure, blue

Part no.: 903780

Technical specifications

With the weatherproof enclosure, the protection rating rises from IP42 to IP54 for the manual call points DMX3000, DMX3000 Ex, DMX95-I and DMX95.

Color	RAL 5015, blue
Weight	0.28 kg (0.1 lbs)

Included in delivery

Weatherproof enclosure with seal set and gland M 20 x 1.5

Weatherproof enclosure, green

Part no.: 903791

Technical specifications

With the weatherproof enclosure, the protection rating rises from IP42 to IP54 for the manual call points DMX3000, DMX3000 Ex, DMX95-I and DMX95.

Color	RAL 6002, green
Weight	0.28 kg (0.1 lbs)

Included in delivery

Weatherproof enclosure with seal set and gland M 20 x 1.5



Manual call points

Indoor application, accessories

Weatherproof enclosure HME



Part no.: 4004909

red

Part no.: 4004910

blue

Part no.: 4004911

yellow

Part no.: 4004912

green

Weatherproof enclosure for Manual call points of HME series provides protection from environmental influences and mechanical protection.

Technical specifications

Enclosure	Stainless steel
Weight	250 g (0.55 inch)
Dimensions	130 x 145 x 55 mm (WxHxD) 5.1 x 5.7 x 2.2 inch (WxHxD)

Door key HME

Part no.: 4004913

Key for opening manual call points of HME series.

Included in delivery

PU = 10 pcs.

Glass sheet HME

Part no.: 4004914

Glass sheet for manual call points of HME series.

Technical specifications

Dimensions	80 x 80 x 0,9 mm (WxHxD) 3.2 x 3.2 x 0.04 inch (WxHxD)
------------	---

Included in delivery

PU = 10 pcs.

Protection kit HME to IP54



Part no.: 4004915

With the Protection kit for manual call points of HME series, the protection rating rises from IP43 to IP54.

Included in delivery

Sealing components
Cable gland M20 x 1.5
Installation material



Manual call points

DMX indoor application, accessories

Detector element DMX symbol **Part no.: 904449**

Detector element DMX symbol LED **Part no.: 904450**

DMX3000 card **Part no.: 907764**

DMX3000 card, LED **Part no.: 907765**

DMX3000 card, 2GRU **Part no.: 907766**

DMX3000 card, LED ext. **Part no.: 907728**

Special labeling for outside and inside sign

Part no.: 903371

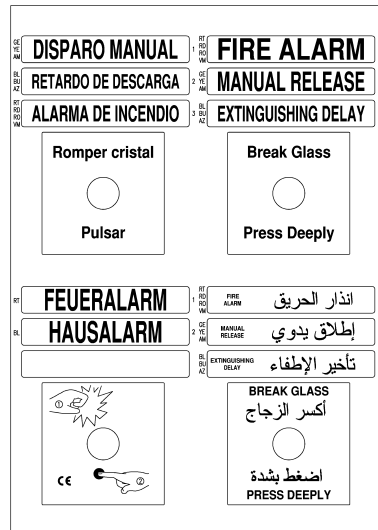

French labeling

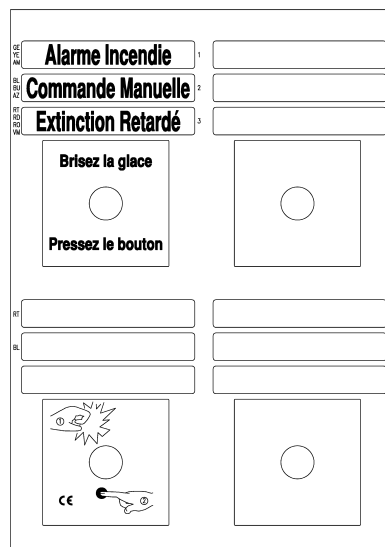



Manual call points

DMX outdoor application

Overview outdoor application

Application Accessories Replacement	Application							Accessories		Replacement						
	IP rating	Short circuit isolator	Ex Zone	Approvals/ Norms (further approval on catalogue page)	Alarm-LED	Latching contact (R) Non-Latching contact (T)	Conventional (C) Addressable (A)	Silicone-free	Special labeling for white inside panel (907192)	Individual labeling (outside)	Board DMX3100 SUX95, switch (907890)	Board DMX3100 SUX95, button (907912)	Board DMX3100, switch (907883)	Board DMX3100, button (907884)	Board DMX3100, 2GRU, switch (907887)	Board DMX3100, ZDP, switch (907886)
906939 DMX3100 Manual Call Point, red	IP 66	---	---	VdS EN 54-11	---	R	G	---	X ¹	---	---	X	---	---	---	---
918153 DMX3100, red	IP 66	---	---	---	---	R	G	---	X ¹	---	---	X	---	---	---	---
908622 DMX3195-I Manual Call Point, red	IP 66	X	---	VdS EN 54-11 EN 54-17	X	R	A	---	X ¹	---	---	---	---	---	---	---
910815 DMX3195-I, red	IP 66	X	---	---	X	R	A	---	X ¹	BA	---	---	---	---	---	---
912580 KAX DIS 951r WP Manual Call Point, red	IP 67	X	---	EN 54-11	X	R	A	---	---	---	---	---	---	---	---	---
908711 dc31 Ex Manual Call Point, red	IP 66	---	1 21	VdS EN 54-11 ATEX	---	R	G	---	X ¹	---	---	---	---	---	---	---
901321 KAX95 Ex Manual Call Point, red	IP 67	---	0 20	EN 54-11 ATEX	X	R	A	---	---	---	---	---	---	---	---	---
906940 DMX3100 Manual Release, yellow	IP 66	---	---	VdS EN 12094-3	---	R	G	---	X ¹	---	---	X	---	---	---	---
918154 DMX3100, yellow	IP 66	---	---	---	---	R	G	---	X ¹	---	---	X	---	---	---	---
907024 DMX3100 2GRU Manual Release, yellow	IP 66	---	---	VdS EN 12094-3	---	R	G	---	X ¹	---	---	---	---	X	---	---
908623 DMX3195-I Manual Release, yellow	IP 66	X	---	VdS EN 12094-3 EN 54-17	X	R	A	---	X ¹	LU	---	---	---	---	---	---
910553 DMX3195-I, yellow	IP 66	X	---	---	X	R	A	---	X ¹	BA	---	---	---	---	---	---
908712 dc31 Ex Manual Release, yellow	IP 66	---	1 21	VdS EN 12094-3 ATEX	---	R	G	---	X ¹	---	---	---	---	---	---	---
912581 KAX95 Ex Manual Release, yellow	IP 67	---	0 20	ATEX	X	R	A	---	---	---	---	---	---	---	---	---

310-010_002 / A102 / 2019-Jan-01 / en
The contents of this publication are subject to modifications without notice. All rights reserved.

Trusted above all.















Manual call points

DMX outdoor application

Overview outdoor application

Application Accessories Replacement	Application								Accessories		Replacement					
	IP rating	Short circuit isolator	Ex Zone	Approvals/ Norms (further approval on catalogue page)	Alarm-LED	Latching contact (R) Non-Latching contact (T)	Conventional (G) Addressable (A)	Silicone-free	Special labeling for white inside panel (907192)	Individual labeling (outside)	Board DMX3100 SUX95, switch (907890)	Board DMX3100 SUX95, button (907912)	Board DMX3100, switch (907883)	Board DMX3100, button (907884)	Board DMX3100, 2GRU, switch (907887)	Board DMX3100, ZDP, switch (907886)
907021 DMX3100 Emergency Button, blue 	IP 66	---	---	VdS EN 12094-3	---	T	G	---	X ¹	---	---	---	X	---	---	---
918155 DMX3100, blue 	IP 66	---	---	---	---	T	G	---	X ¹	---	---	---	X	---	---	---
910554 DMX3195-I, blue 	IP 66	X	---	---	X	T	A	---	X ¹	BA	---	---	---	---	---	---
908713 dc31 Ex Emergency Button, blue 	IP 66	---	1 21	VdS EN 12094-3 ATEX	---	T	G	---	X ¹	---	---	---	---	---	---	---
907022 DMX3100 2nd Release, green 	IP 66	---	---	VdS EN 12094-3	---	T	G	---	X ¹	---	---	---	X	---	---	---
918156 DMX3100, green 	IP 66	---	---	---	---	T	G	---	X ¹	---	---	---	X	---	---	---
910824 DMX3195-I, green 	IP 66	X	---	---	X	T	A	---	X ¹	BA	---	---	---	---	---	---
908714 dc31 Ex 2nd Release, green 	IP 66	---	1 21	VdS EN 12094-3 ATEX	---	T	G	---	X ¹	---	---	---	---	---	---	---
909032 DMX3100 variable 	IP 66	---	---	X2	---	X ²	G	AA	X ¹	X ¹	---	---	X ²	X ²	---	---
910725 DMX3195-I variable 	IP 66	X ²	---	X2	X	X ²	A	AA	X ¹	X ¹	---	---	---	---	---	---
Older DMX versions 	---	---	---	---	---	---	---	---	---	---	X ²	X ²	X ²	X ²	X ²	X ²

X¹ = Manual Call Point is perhaps not approval compliant

X² = Depending on the variable type of detector

AA = On request

LU = Included in delivery (see labeling table at the product page)

BA = Information about the labeling required



Manual call points

DMX outdoor application, addressable

DMX3195-I manual call point, red



Technical specifications

Function	Type B, latching contact
Color alarm LED	red
Technology / protocol	Loop AP / XP95
Integrated short circuit isolator	yes
Operating voltage	17 V - 28 V DC
Operating current	200 µA
Starting current (max.)	1 mA
IP rating (EN 60529)	IP 66
Enclosure material	PC
Color	RAL 3001, red
Trigger mechanism material	POM
Operating temperature	-20 °C to +60 °C (-4 °F to +140 °F)
Relative humidity	0 to 95% no condensation
Specification according to	EN 54-11
Weight	526 g (1.2 lbs)
Dimensions	135 x 161 x 61 mm (WxHxD) 5.3 x 6.3 x 2.4 inch (WxHxD))

Part no.: 908622

Analog addressable manual call point for outdoor areas, in accordance with EN 54-11. Applicable for operation in fire alarm panels with Loop AP protocol. Addressing via DIP switches; the address can also be modified after installation. The detector has a built-in isolator.

If the labeling does not comply with VdS or EN 54-11 standards, part no. 910815 or 910725 must be used.

The white internal plate can be replaced by other labeling (see DMX External application accessories).

If the labeling does not comply with applicable standards, the VdS and EN 54-11 approvals will void.

Included in delivery

Mounting hardware

1 Door key

2 Cable glands M20 x 1.5

1 Blanking plug

Connection / mounting

Connection cable

2-wire

Recommended cable, standard

747180

J-Y(ST)Y-2x2x0.8 mm

Recommended cable for circuit integrity

907940

JE-H(ST)H E30 2x2x0.8 mm

Conductor cross-section

max. 2.5 mm² (AWG 13)

Electrostatic shielding

not required

Note

Strong magnetic fields should be avoided in the vicinity of the detectors.

Approvals / marking



G 211004



0786-CPD-21146



Manual call points

DMX outdoor application, addressable



DMX3195-I manual release, yellow

Technical specifications

Function	Type B, latching contact
Color	similar RAL 1021, yellow
Specification according to	EN 12094-3

Excerpt from label texts

HANDAUSLÖSUNG - Gaslöschanlage	ΧΕΙΡΟΚΙΝΗΤΟΣ ΔΙΑΚΟΠΤΗΣ - Συσκευή κατασβεστής με αέριο
MANUAL RELEASE - Gas extinguishing system	CO2 ЗАПУСТИТЬ
DISPOSITIVO MANUAL DE DISPARO - Sistema de extinción por gas	РУЧНОЙ ПУСК
COMMANDE MANUELLE - Système d'extinction à gaz	ΡΥΧΝΟ ΙΣΠΥΣΚΑΝΕ - Ινсталация за гасене с газообразно вещество
RILASCIO MANUALE - Impianto di estinzione a gas	
HANDBEDIENING - Blusgas installatie	
RANKINIS PALEIDIMAS - Gesinimo dujomis sistema	
STARTS - IESLĒGŠANA AR ROKU Dzēšanas sistēma ar gāzi	
KÄSILAUKAISU - Kaasusammutuslaitteistot	
MANUELL AKTIVERING - Gassläcksystem	

Part no.: 908623

The manual call point in the yellow enclosure according to EN 12094-3 can be used for the electrical triggering of gas extinguishing systems. If the labeling does not comply with VdS or EN 12094-3, part no. 910553 or 910725 may be used. If the labeling does not comply with applicable standards, the VdS and EN 12094-3 approvals will void.

Included in delivery

- Mounting hardware
- 2 Cable glands M20 x 1.5
- 1 Door key
- 1 Blanking plug
- 1 Labeling kit (multilingual) with 14 labels see excerpt from label texts

Note

The labeling kit (multilingual) complies with EN 12094-3 for national and international applications.

Approvals / marking



G 211011



0786-CPD-21147



Manual call points

DMX outdoor application, addressable

DMX3195-I, red



Technical specifications

Function	Type B, latching contact
Color alarm LED	red
Technology / protocol	Loop AP / XP95
Integrated short circuit isolator	yes
Operating voltage	17 V - 28 V DC
Operating current	200 µA
Starting current (max.)	1 mA
IP rating (EN 60529)	IP 66
Enclosure material	PC
Color	similar to RAL 3001, red
Trigger mechanism material	POM plastic
Operating temperature	-20 °C to +60 °C (-4 °F to +140 °F)
Relative humidity	0 to 95% no condensation
Weight	526 g (1.2 lbs)
Dimensions	135 x 161 x 61 mm (WxHxD) 5.3 x 6.3 x 2.4 inch (WxHxD)

Part no.: 910815

Analog addressable manual call point for outdoor areas similar to EN 54-11. Applicable for operation in fire alarm panels with Loop AP protocol. Addressing via DIP switches. The address can also be modified after installation. The detector has a built-in isolator. For use of the manual call point in other applications, such as „Fire alarm“, the inscription label is affixed on the enclosure by the factory. The white internal plate can be replaced by other labeling (see DMX External application accessories). **In case of order the arbitrary/variable label text it is to be indicated under „Information for production“.**

Included in delivery

Mounting hardware
1 Door key
2 Cable glands M20 x 1.5
1 Blanking plug

Connection / mounting

Connection cable 2-wire
Recommended cable, standard 747180
J-Y(ST)Y-2x2x0.8 mm
Recommended cable for circuit integrity 907940
JE-H(ST)H E30 2x2x0.8 mm
Conductor cross-section max. 2.5 mm² (AWG 13)
Electrostatic shielding not required

Note

Strong magnetic fields are to be avoided in the vicinity of the detectors.

Excerpt from label texts

Drucktext	Sprache	Deutsche Übersetzung
FEUERALARME	deutsch	Feueralarm
FEUERWEHR	deutsch	Feuerwehr
FIRE ALARM	englisch	Feueralarm
ALARMA DE INCENDIO	spanisch	Feueralarm
ALARME INCENDIE	französisch	(Brand-) Feueralarm
ALARME FEU	französisch	Feueralarm
ALLARME ANTINCENDIO	italienisch	Feueralarm
HANDMELDER	holländisch	Handmelder
POŻAR	polnisch	Feueralarm
POŽIARNY POPLACH	slowakisch	Feueralarm
إنذار الحريق	arabisch	Feueralarm
FIRE ALARM إنذار الحريق	engl./arab.	Feueralarm
POŽIARNY POPLACH FIRE ALARM	slowak./engl.	Feueralarm



Manual call points

DMX outdoor application, addressable



DMX3195-I, yellow

Part no.: 910553

Technical specifications

Function	Type B, latching contact
Color	similar to RAL 1021, yellow

In case of order the arbitrary/variable label text it is to be indicated under „Information for production“ (see excerpt from label texts).

Otherwise like part no.: 910815

Excerpt from label texts

Drucktext	Sprache	Deutsche /engl. Übersetzung
HANDAUSLÖSUNG	deutsch	Handauslösung
HANDAUSLÖSUNG - Löschanlage	deutsch	Handauslösung - Löschanlage
LÖSCHANLAGE	deutsch	Löschanlage
MANUAL RELEASE	englisch	Handauslösung
CO2 RELEASE	englisch	CO2-Auslösung
CO2 MANUAL RELEASE	englisch	CO2 Handauslösung
WATER RELEASE	englisch	Wasserauslösung
GAS RELEASE	englisch	Gasauslösung
DELUGE MANUAL RELEASE	englisch	Sprühflut Handauslösung
DISPARO MANUAL	spanisch	Handauslösung
COMMANDE MANUELLE	französisch	Handauslösung
DECLENCHÉMENT MANUEL	französisch	Handauslösung
DECLENCHÉMENT CO2	französisch	CO2 Auslösung
RILASCIO MANUALE	italienisch	Handauslösung
BLUSSING	holländisch	Löschung
HAND ACTIVERING	holländisch	Manuelle Löschung
MANUELE BEDIENING	holländisch	Manuelle Bedienung
BEDIENING BLUSINSTALLATIE	holländisch	Bedienung Löschen
SPROEIVLOED	holländisch	Löschmittel Zufuhr
DECLANȘARE MANUALĂ	rumänisch	Handauslösung
RUČNÉ SPUSTENIE	slowakisch	Handauslösung
CO2 RUČNÉ SPUSTENIE	slowakisch	CO2 Handauslösung
RUČNÉ SPUSTENIE DELUŽNE	slowakisch	Sprühflut Handauslösung
إطلاق يدوي	arabisch	Handauslösung
إطلاق المياه	arabisch	Wasserauslösung
إطلاق الغاز	arabisch	Gasauslösung
إطلاق الرغوة	arabisch	Schaumauslösung
مراقب إطلاق الرغوة	arabisch	Foam Monitor Release
حقن الرغوة	arabisch	Foam Injection
حاجز الرغوة	arabisch	Foam Dyke
MANUAL RELEASE	engl./arab.	Handauslösung
إطلاق يدوي		
CO2 RUČNÉ SPUSTENIE	slowak./engl.	CO2-Handauslösung
CO2 MANUAL RELEASE		
RUČNÉ SPUSTENIE DELUŽNE	slowak./engl.	Sprühflut Handauslösung
DELUGE MANUAL RELEASE		

Drucktext	Sprache	Deutsche /engl. Übersetzung
WATER RELEASE	engl./arab.	Wasserauslösung
إطلاق المياه		
GAS RELEASE	engl./arab.	Gasauslösung
إطلاق الغاز		
FOAM RELEASE	engl./arab.	Schaumauslösung
إطلاق الرغوة		
FOAM MONITOR RELEASE	engl./arab.	Foam Monitor Release
مراقب إطلاق الرغوة		
FOAM INJECTION	engl./arab.	Foam Injection
حقن الرغوة		
FOAM DYKE	engl./arab.	Foam Dyke
حاجز الرغوة		
MANUAL RELEASE	engl./russ.	Handauslösung
РУЧНОЙ ПУСК		
CO2 RUČNÉ SPUSTENIE	slowak./engl.	CO2-Handauslösung
CO2 MANUAL RELEASE		
RUČNÉ SPUSTENIE DELUŽNE	slowak./engl.	Sprühflut Handauslösung
DELUGE MANUAL RELEASE		

Approvals / marking





Manual call points

DMX outdoor application, addressable



DMX3195-I, green

Technical specifications

Function	Type B, non-latching contact
Color	similar to RAL 6002, green

Approvals / marking



Part no.: 910824

In case of order the arbitrary/variable label text it is to be indicated under „Information for production“ (see excerpt from label texts).
Otherwise like part no.: 910815

Excerpt from label texts

Drucktext	Sprache	Deutsche Übersetzung
NACHLÖSCHEN	deutsch	Nachlöschen
NACHFLUTEN - Gaslöschanlage	deutsch	NACHFLUTEN - Gaslöschanlage
2-te AUSLÖSUNG	deutsch	2-te Auslösung
2-te LÖSCHAUSLÖSUNG	deutsch	2-te Löschauslösung
2nd RELEASE	englisch	2-te Auslösung
2nd EXT. RELEASE	englisch	2-te Löschauslösung
STINGERE SUPLIMENTARĂ	rumänisch	Nachlöschen
CO2 DOHASENIE	slowakisch	CO2 Nachlöschen
DOHASENIE	slowakisch	Nachlöschen
DOHASENIE SECOND DISCHARGE	slowak./engl.	Nachlöschen

DMX3195-I, blue

Technical specifications

Function	Type B, non-latching contact
Color	similar to RAL 5015, blue

Part no.: 910554

In case of order the arbitrary/variable label text it is to be indicated under „Information for production“ (see excerpt from label texts).
Otherwise like part no.: 910815

Excerpt from label texts

Drucktext	Sprache	Deutsche / engl. Übersetzung
LÖSCHVERZUG	deutsch	Löschverzögerung
HAUSALARM	deutsch	Hausalarm
STOPP-TASTER Gaslöschanlage	deutsch	STOPP-TASTER - Gaslöschanlage
HANDBRANDMELDER	deutsch	Handbrandmelder
EMERGENCY STOP Gas extinguishing system	englisch	STOPP-TASTER - Gaslöschanlage
EXTINGUISHING DELAY	englisch	Löschverzögerung
PARO DE EMERGENCIA - Sistema de extinción por gas	spanisch	STOPP-TASTER - Gaslöschanlage
RETARDO DE DESCARGA	spanisch	Löschverzögerung
ARRET D'URGENCE - Système d'extinction à gaz	französisch	STOPP-TASTER - Gaslöschanlage
RETARDEMENT D'EXTINCTION GAZ	französisch	Löschverzögerung
ARRESTO DI EMERGENZA - Impianto di estinzione a gas	italienisch	STOPP-TASTER - Gaslöschanlage
ARRESTO CO2	italienisch	CO2-Stop
NOODSTOP - Blusgas installatie	holländisch	STOPP-TASTER - Gaslöschanlage
UITSTEL BLUSSING	holländisch	Löschung aus

Approvals / marking



Drucktext	Sprache	Deutsche / engl. Übersetzung
AVARINIS STABDYMAS Gesindeimo dujomis sistema	litauisch	EMERGENCY STOP Gas extinguishing system
STOP - AVĀRIJAS IZSLĒGŠANA Dzēšanas sistēma ar gāzi	lettisch	STOPP-TASTER - Gaslöschanlage
HÄTÄPYSÄYTYYS - Kaasusammutuslaitteistot	finnisch	STOPP-TASTER - Gaslöschanlage
NÖDSTOPP - Gasläcksystem	schwedisch	STOPP-TASTER - Gaslöschanlage
ΔΙΑΚΟΠΤΗΣ ΕΚΤΑΚΤΗΣ ΑΝΑΓΚΗΣ - Συστημα κατασβεσης με αεριο	griechisch	STOPP-TASTER - Gaslöschanlage
CO2 СТОП	russisch	CO2-Stop
تأخير الإطفاء	arabisch	Löschverzögerung
EXTINGUISHING DELAY تأخير الإطفاء	engl./arab.	Löschverzögerung
АВАРИЙНО СПИРАНЕ Инсталация за газене с газообразно вещество	bulgarisch	STOPP-TASTER - Gaslöschanlage

Trusted above all.

Viking GmbH | Industriestr. 10/12 | D-23840 Bad Oldesloe | www.viking-emea.com





Manual call points

DMX outdoor application, addressable

DMX3195-I, variable

Part no.: 910725



Technical specifications

Function	Type B, latching or non-latching contact
Color alarm LED	red
Technology / protocol	Loop AP / XP95
Integrated short circuit isolator	yes
Rated voltage	9 V
Operating voltage	17 V - 28 V DC
Operating current	200 mA
Initial current max.	1 mA
IP rating (EN 60529)	IP 66
Enclosure material	PC
Color	RAL 3001, red RAL 1021, yellow RAL 5015, blue RAL 6002, green
Trigger mechanism material	POM plastic
Operating temperature	-20 °C to +60 °C (-4 °F to +140 °F)
Relative humidity	0 to 95% no condensation
Specification according to	similar to EN 54-11 and EN 12094-3
Weight	approx. 525 g (1.16 lbs)
Dimensions	135 x 161 x 61 mm (WxHxD) 5.3 x 6.3 x 2.4 inch (WxHxD)

Analog addressable manual call point for outdoor areas similar to EN 54-11 or EN 12094-3. **Free selection of the detector configuration possible (Latching or non-latching contact, silicone free, special labeling).**

Applicable for operation in fire panels with Loop AP protocol. Addressing via DIP switches. The address can also be modified after installation. The order is placed along with an additional note on the detector, with order number and the desired modifications. Production is then performed manually. A contract review will be performed in order to comply with regulations. The description and connection instructions are attached to the detector.

Included in delivery

Mounting hardware
1 Door key
2 Cable glands M20 x 1.5
1 Blanking plug

Connection / mounting

Connection cable	2-wire
Recommended cable, standard	747180
J-Y(ST)Y-2x2x0.8 mm	
Recommended cable for circuit integrity	907940
JE-H(ST)H E30 2x2x0.8 mm	
Conductor cross-section	max. 2.5 mm ² (AWG 13)
Electrostatic shielding	not required

Note

Strong magnetic fields are to be avoided in the vicinity of the detectors.

Approvals / marking





Manual call points

DMX outdoor application, addressable

KAX DIS 951 WP manual call point, red

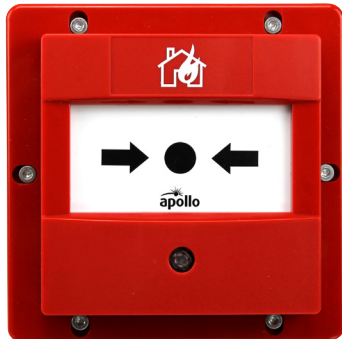

Part no.: 912580

Analog addressable manual call point outdoor areas with integrated isolator, in accordance with EN 54-11. Applicable for operation in fire alarm panels with Loop AP protocol. Addressing via DIP switches, the address can also be modified after installation. Markings or labels which do not comply with the standard will void the EN 54-11 approval. Operating instructions and address information are included with the detector.

Technical specifications

Function	Type A, latching contact
Technology / protocol	Loop AP / Discovery
Integrated short circuit isolator	yes
No. of detectors per loop for mixed automatic and manual	max. 126
Operating voltage	17 V - 28 V DC
Operating current	100 µA
Alarm current	4 mA
Alarm indication	1 LED, red
IP rating (EN 60529)	IP 67
Enclosure material	PC / ABS
Color	red
Operating temperature	-40 °C to + 70 °C (-40 °F to +158 °F)
Relative humidity	0 to 95% no condensation
Specification according to	EN 54-11 and EN 54-17
Weight	approx. 210 g (0.46 lbs)
Dimensions	112 x 112 x 71 mm (WxHxD) 4.4 x 4.4 x 2.8 inch (WxHxD)

Included in delivery

1 Key to reset/open the MCP
Operating instructions
Address information

Not included in delivery

Mounting hardware

Note

This detector does not have a glass pane, but a resettable trigger mechanism. For resetting after activation, use the supplied reset key.

Connection / mounting

Connection cable	2-wire
Recommended cable, standard	747180
J-Y(ST)Y-2x2x0.8 mm	
Recommended cable for circuit integrity	907940
JE-H(ST)H E30 2x2x0.8 mm	
Conductor cross-section	max. 2.5 mm ² (AWG 13)
Electrostatic shielding	not required

Approvals / marking

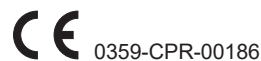



Manual call points

DMX outdoor application, conventional

DMX3100 manual call point, red



Technical specifications

Function	Type B, latching contact
Technology	Conventional
Rated voltage	9 V
Operating voltage	7.6 V - 13.2 V DC
Quiescent current	5 mA (at 9 V)
Alarm current	20 mA (at 9 V)
IP rating (EN 60529)	IP 66
Enclosure material	PC
Color	RAL 3001, red
Trigger mechanism material	POM plastic
Operating temperature	- 35 °C to +60 °C (-31 °F to +140 °F)
Relative humidity	0 to 95% no condensation
Specification according to	EN 54-11
Weight	475 g (1.1 lbs)
Dimensions	135 x 161 x 61 mm (WxHxD) 5.3 x 6.3 x 2.4 inch (WxHxD)

Part no.: 906939

Conventional manual call point for outdoor areas in accordance with EN 54-11. Applicable for operation on conventional lines. The white inside sign can be replaced with other labels (see DMX outdoor application, accessories). Markings or labels which do not comply with the standard will void the VdS and EN 54-11 approvals.

Included in delivery

Mounting hardware
1 Door key
2 Cable glands M20 x 1.5
1 Blanking plug

Connection / mounting

Connection cable	2-wire
Recommended cable, standard	747180
J-Y(ST)Y-2x2x0.8 mm	
Recommended cable for circuit integrity	907940
JE-H(ST)H E30 2x2x0.8 mm	
Conductor cross-section	max. 2.5 mm ² (AWG 13)
Electrostatic shielding	not required

Note

Strong magnetic fields should be avoided in the vicinity of the detectors.

Approvals / marking



G 209029



0786-CPD-20688



Manual call points

DMX outdoor application, conventional

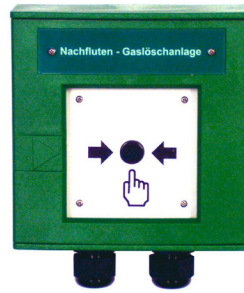

DMX3100 manual release, yellow

Part no.: 906940

Technical specifications

Function	Type B, latching contact
Color	RAL 1021, yellow
Specification according to	EN 12094-3

Approvals / marking



G 209030



0786-CPD-20689

Note

This MCP uses German labeling.
For other languages please use the part no. 909032

Otherwise like part no. 906939

Markings or labels which do not comply with the standard will void the VdS and EN 12094-3 approvals.

DMX3100 emergency button, blue

Part no.: 907021

Technical specifications

Function	Type B, non-latching contact
Color	RAL 5015, blue
Specification according to	EN 12094-3

Approvals / marking



G 209031



0786-CPD-20690

Note

This MCP uses German labeling.
For other languages please use the part no. 909032

Otherwise like part no. 906939

Markings or labels which do not comply with the standard will void the VdS and EN 12094-3 approvals.

DMX3100 2nd release, green

Part no.: 907022

Technical specifications

Function	Type B, non-latching contact
Color	RAL 6002, green
Specification according to	similar to EN 12094-3

The outside sign is as specified by VdS 2496 Issue 12.96.

Approvals / marking



G 209031

Note

This MCP uses German labeling.
For other languages please use the part no. 909032

Otherwise like part no. 906939

Markings or labels which do not comply with the standard will void the VdS approval.



Manual call points

DMX outdoor application, conventional

DMX3100 2GRU manual release, yellow



Technical specifications

Function	Type B, latching contact
Technology	Conventional
Rated voltage	9 V
Operating voltage	7.6 V - 13.2 V DC
Quiescent current	5 mA (at 9 V)
Alarm current	20 mA (at 9 V)
IP rating (EN 60529)	IP 66
Enclosure material	PC
Color	RAL 1021, yellow
Trigger mechanism material	POM plastic
Operating temperature	-35 °C to +60 °C (-31 °F to +140 °F)
Relative humidity	0 to 95% no condensation
Specification according to	EN 12094-3
2GRU	2 microswitches for 2 zones
Weight	475 g (1.1 lbs)
Dimensions	135 x 161 x 61 mm (WxHxD) 5.3 x 6.3 x 2.4 inch (WxHxD)

Part no.: 907024

Conventional manual call point for outdoor areas in accordance with EN 12094-3. Applicable for operation on conventional lines. The outside sign and the white inside sign can be replaced with other labels (see DMX outdoor application, accessories). Markings or labels which do not comply with the standard will void the VdS and EN 12094-3 approvals. The DMX3100 2GRU is designed for 2-line/zone coincidence. Two alarm lines are activated if the trigger button is pressed.

Included in delivery

Mounting hardware
1 Door key
2 Cable glands M20 x 1.5
1 Blanking plug

Connection / mounting

Connection cable	2-wire
Recommended cable, standard	747180
J-Y(ST)Y-2x2x0.8 mm	
Recommended cable for circuit integrity	907940
JE-H(ST)H E30 2x2x0.8 mm	
Conductor cross-section	max. 2.5 mm ² (AWG 13)
Electrostatic shielding	not required

Note

Strong magnetic fields should be avoided in the vicinity of the detectors. This MCP uses German labeling. For other languages please use the part no. 909032.

Approvals / marking



G 209030



0786-CPD-20689



Manual call points

DMX outdoor application, conventional

DMX3100 manual call point, variable

Part no.: 909032



Technical specifications

Function	Type B, latching or non-latching contact
Technology	Conventional
Rated voltage	9 V
Operating voltage	7.6 V - 13.2 V DC
Quiescent current	5 mA (at 9 V)
Alarm current	20 mA (at 9 V)
IP rating (EN 60529)	IP 66
Enclosure material	PC
Color	RAL 3001, red RAL 1021, yellow RAL 5015, blue RAL 6002, green
Trigger mechanism material	POM plastic
Operating temperature	-35 °C to +60 °C (-31 °F to +140 °F)
Relative humidity	0 to 95% no condensation
Specification according to	similar to EN 54-11 and EN 12094-3
Weight	approx. 475 g (1.1 lbs)
Dimensions	135 x 161 x 61 mm (WxHxD) 5.3 x 6.3 x 2.4 inch (WxHxD)

Conventional manual call point for outdoor areas similar to EN 54-11 and EN 12094-3. **Free selection of the detector configuration possible (Latching or non-latching contact, silicone free, special labeling).** The order is placed along with an additional note on the detector, with order number and the desired modifications. Production is then performed manually. A contract review will be performed in order to comply with regulations. Operating instructions and connection notes are included with the detector.

Included in delivery

Mounting hardware
1 Door key
2 Cable glands M20 x 1.5
1 Blanking plug

Connection / mounting

Connection cable	2-wire
Recommended cable, standard	747180
J-Y(ST)Y-2x2x0.8 mm	
Recommended cable for circuit integrity	907940
JE-H(ST)H E30 2x2x0.8 mm	
Conductor cross-section	max. 2.5 mm ² (AWG 13)
Electrostatic shielding	not required

Note

Strong magnetic fields should be avoided in the vicinity of the detectors.

Approvals / marking





Manual call points

DMX outdoor application, conventional

DMX3100, red



Technical specifications

Function	Type B, latching contact
Technology	Conventional
Rated voltage	9 V
Operating voltage	7.6 V - 13.2 V DC
Quiescent current	5 mA (at 9 V)
Alarm current	20 mA (at 9 V)
IP rating (EN 60529)	IP 66
Enclosure material	PC
Color	RAL 3001, red
Trigger mechanism material	POM plastic
Operating temperature	- 35 °C to +60 °C (-31 °F to +140 °F)
Relative humidity	0 to 95% no condensation
Weight	475 g (1.1 lbs)
Dimensions	135 x 161 x 61 mm (WxHxD) 5.3 x 6.3 x 2.4 inch (WxHxD)

Approvals / marking



Part no.: 918153

Conventional manual call point for outdoor areas similar to EN 54-11. Applicable for operation on conventional lines. The white inside sign can be replaced with other labels (see DMX outdoor application, accessories).

In case of order the arbitrary/variable label text it is to be indicated under „Information for production“.

Included in delivery

Mounting hardware
1 Door key
2 Cable glands M20 x 1.5
1 Blanking plug

Connection / mounting

Connection cable 2-wire
Recommended cable, standard 747180
J-Y(ST)Y-2x2x0.8 mm
Recommended cable for circuit integrity 907940
JE-H(ST)H E30 2x2x0.8 mm
Conductor cross-section max. 2.5 mm² (AWG 13)
Electrostatic shielding not required

Note

Strong magnetic fields should be avoided in the vicinity of the detectors.

Excerpt from label texts

Drucktext	Sprache	Deutsche Übersetzung
FEUERALARME	deutsch	Feueralarm
FEUERWEHR	deutsch	Feuerwehr
FIRE ALARM	englisch	Feueralarm
ALARMA DE INCENDIO	spanisch	Feueralarm
ALARME INCENDIE	französisch	(Brand-) Feueralarm
ALARME FEU	französisch	Feueralarm
ALLARME ANTINCENDIO	italienisch	Feueralarm
HANDMELDER	holländisch	Handmelder
POŻAR	polnisch	Feueralarm
POŽIARNY POPLACH	slowakisch	Feueralarm
إنذار الحريق	arabisch	Feueralarm
FIRE ALARM إنذار الحريق	engl./arab.	Feueralarm
POŽIARNY POPLACH FIRE ALARM	slowak./engl.	Feueralarm



Manual call points

DMX outdoor application, conventional



DMX3100 manual release, yellow

Part no.: 918154

Technical specifications

Function	Type B, latching contact
Color	similar to RAL 1021, yellow

In case of order the arbitrary/variable label text it is to be indicated under „Information for production“ (see excerpt from label texts).

Otherwise like part no.: 918153

Excerpt from label texts

Drucktext	Sprache	Deutsche /engl. Übersetzung
HANDAUSLÖSUNG	deutsch	Handauslösung
HANDAUSLÖSUNG - Löschanlage	deutsch	Handauslösung - Löschanlage
LÖSCHANLAGE	deutsch	Löschanlage
MANUAL RELEASE	englisch	Handauslösung
CO2 RELEASE	englisch	CO2-Auslösung
CO2 MANUAL RELEASE	englisch	CO2 Handauslösung
WATER RELEASE	englisch	Wasserauslösung
GAS RELEASE	englisch	Gasauslösung
DELUGE MANUAL RELEASE	englisch	Sprühflut Handauslösung
DISPARO MANUAL	spanisch	Handauslösung
COMMANDE MANUELLE	französisch	Handauslösung
DECLENCHÉMENT MANUEL	französisch	Handauslösung
DECLENCHÉMENT CO2	französisch	CO2 Auslösung
RILASCIO MANUALE	italienisch	Handauslösung
BLUSSING	holländisch	Löschung
HAND ACTIVERING	holländisch	Manuelle Löschung
MANUELE BEDIENING	holländisch	Manuelle Bedienung
BEDIENING BLUSINSTALLATIE	holländisch	Bedienung Löschen
SPROEIVLOED	holländisch	Löschmittel Zufuhr
DECLANŞARE MANUALĂ	rumänisch	Handauslösung
RUČNÉ SPUSTENIE	slowakisch	Handauslösung
CO2 RUČNÉ SPUSTENIE	slowakisch	CO2 Handauslösung
RUČNÉ SPUSTENIE DELUŽNE	slowakisch	Sprühflut Handauslösung
إطلاق يدوي	arabisch	Handauslösung
إطلاق المياه	arabisch	Wasserauslösung
إطلاق الغاز	arabisch	Gasauslösung
إطلاق الرغوة	arabisch	Schaumauslösung
مراقب إطلاق الرغوة	arabisch	Foam Monitor Release
حقن الرغوة	arabisch	Foam Injection
حاجز الرغوة	arabisch	Foam Dyke
MANUAL RELEASE	engl./arab.	Handauslösung
إطلاق يدوي		
CO2 RUČNÉ SPUSTENIE	slowak./engl.	CO2-Handauslösung
CO2 MANUAL RELEASE		
RUČNÉ SPUSTENIE DELUŽNE	slowak./engl.	Sprühflut Handauslösung
DELUGE MANUAL RELEASE		

Drucktext	Sprache	Deutsche /engl. Übersetzung
WATER RELEASE	engl./arab.	Wasserauslösung
إطلاق المياه		
GAS RELEASE	engl./arab.	Gasauslösung
إطلاق الغاز		
FOAM RELEASE	engl./arab.	Schaumauslösung
إطلاق الرغوة		
FOAM MONITOR RELEASE	engl./arab.	Foam Monitor Release
مراقب إطلاق الرغوة		
FOAM INJECTION	engl./arab.	Foam Injection
حقن الرغوة		
FOAM DYKE	engl./arab.	Foam Dyke
حاجز الرغوة		
MANUAL RELEASE	engl./russ.	Handauslösung
РУЧНОЙ ПУСК		
CO2 RUČNÉ SPUSTENIE	slowak./engl.	CO2-Handauslösung
CO2 MANUAL RELEASE		
RUČNÉ SPUSTENIE DELUŽNE	slowak./engl.	Sprühflut Handauslösung
DELUGE MANUAL RELEASE		

Approvals / marking





Manual call points

DMX outdoor application, conventional



DMX3100 2nd release, green

Technical specifications

Function	Type B, non-latching contact
Color	similar to RAL 6002, green

Approvals / marking



Part no.: 918156

In case of order the arbitrary/variable label text it is to be indicated under „Information for production“ (see excerpt from label texts).
Otherwise like part no.: 918153

Excerpt from label texts

Drucktext	Sprache	Deutsche Übersetzung
NACHLÖSCHEN	deutsch	Nachlöschen
NACHFLUTEN - Gaslöschanlage	deutsch	NACHFLUTEN - Gaslöschanlage
2-te AUSLÖSUNG	deutsch	2-te Auslösung
2-te LÖSCHHAUSLÖSUNG	deutsch	2-te Löschauslösung
2nd RELEASE	englisch	2-te Auslösung
2nd EXT. RELEASE	englisch	2-te Löschauslösung
STINGERE SUPLIMENTARĂ	rumänisch	Nachlöschen
CO2 DOHASENIE	slowakisch	CO2 Nachlöschen
DOHASENIE	slowakisch	Nachlöschen
DOHASENIE SECOND DISCHARGE	slowak./engl.	Nachlöschen

DMX3100 emergency button, blue

Technical specifications

Function	Type B, non-latching contact
Color	similar to RAL 5015, blue

Part no.: 918155

In case of order the arbitrary/variable label text it is to be indicated under „Information for production“ (see excerpt from label texts).
Otherwise like part no.: 918153

Excerpt from label texts

Drucktext	Sprache	Deutsche / engl. Übersetzung
LÖSCHVERZUG	deutsch	Löschverzögerung
HAUSALARM	deutsch	Hausalarm
STOPP-TASTER Gaslöschanlage	deutsch	STOPP-TASTER - Gaslöschanlage
HANDBRANDMELDER	deutsch	Handbrandmelder
EMERGENCY STOP Gas extinguishing system	englisch	STOPP-TASTER - Gaslöschanlage
EXTINGUISHING DELAY	englisch	Löschverzögerung
PARO DE EMERGENCIA - Sistema de extinción por gas	spanisch	STOPP-TASTER - Gaslöschanlage
RETARDO DE DESCARGA	spanisch	Löschverzögerung
ARRET D'URGENCE - Système d'extinction à gaz	französisch	STOPP-TASTER - Gaslöschanlage
RETARDEMENT D'EXTINCTION GAZ	französisch	Löschverzögerung
ARRESTO DI EMERGENZA - Impianto di estinzione a gas	italienisch	STOPP-TASTER - Gaslöschanlage
ARRESTO CO2	italienisch	CO2-Stopp
NOODSTOP - Blusgas installatie	holländisch	STOPP-TASTER - Gaslöschanlage
UITSTEL BLUSSING	holländisch	Lösung aus

Approvals / marking





Manual call points

DMX outdoor application, addressable, Ex

KAX95 Ex manual call point, red



Technical specifications

Function	Type A, latching contact
Technology / protocol	Loop AP / XP95
Integrated short circuit isolator	no
Operating voltage	14 V - 22 V DC
Operating current	300 µA
Alarm display	1 LED, red
IP rating (EN 60529)	IP 67
Enclosure material	Polycarbonate /ABS
Color	red
Operating temperature, T4	-20 °C to +60 °C (-4 °F to +140 °F)
Operating temperature, T5	-20 °C to +40 °C (-4 °F to +104 °F)
Relative humidity (IEC 721-3-3)	0 to 95% no condensation
Weight	approx. 240 g (0.53 lbs)
Dimensions	97.5 x 93 x 71 mm (WxHxD) 3.8 x 3.7 x 2.8 inch (WxHxD)

Approvals / marking

Ex conformity in acc. with 2014/34/EU

II 1G Ex ia IIC T5 Ga (-20°C ≤ Ta ≤ +45°C)

II 1G Ex ia IIC T4 Ga (-20°C ≤ Ta ≤ +60°C)

II 1D Ex ia IIIC T135°C Da (-20°C ≤ Ta ≤ +60°C)

Examination certificate:

BAS 02 ATEX 1290



2531-CPR-CSP11014



Part no.: 901321

Analogue addressable manual call point for outdoor use in Ex zone 0 and 20. Provided for use on fire alarm control units with Loop AP protocol. Addressing via DIP switch, the address can also be modified after installation. Detector with intrinsically safe electronics for operation in areas with a risk of explosion. Connection only via an Ex Loop AP 24 V Ex security barrier. Markings or labels which do not comply with the standard will void the EN 54-11 approval.

Included in delivery

1 Key to reset / open the MCP

Connection / mounting

Connection cable 2-wire
Conductor cross-section max. 2.5 mm² (AWG 13)
Electrostatic shielding not required

Note

Analogue addressable detectors for explosive areas are to be used in the Loop AP branch. For this purpose the protocol interface is to be used.

Connection diagram

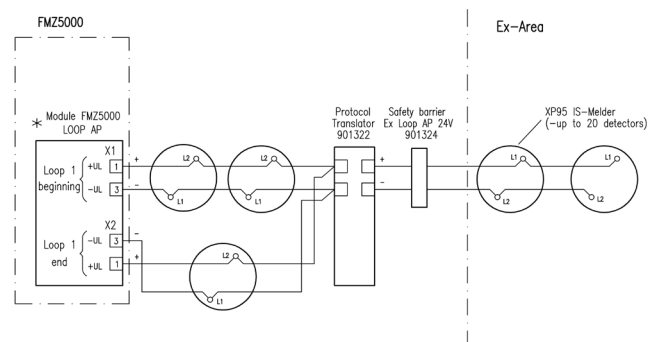

* It can either be the module FMZ5000 LOOP AP (order-no. 902748) or the module FMZ5000 LOOP AP red. (order-no. 904484) can be used.



Manual call points

DMX outdoor application, addressable, Ex

KAX95 Ex manual call point, yellow



Technical specifications

Function	Type A, latching contact
Technology / protocol	Loop AP / XP95
Integrated short circuit isolator	no
Operating voltage	14 V - 22 V DC
Operating current	300 µA
Alarm display	1 LED, red
IP rating (EN 60529)	IP 67
Enclosure material	Polycarbonate /ABS
Color	yellow
Operating temperature, T4	-20 °C to +60 °C (-4 °F to +140 °F)
Operating temperature, T5	-20 °C to +40 °C (-4 °F to +104 °F)
Relative humidity (IEC 721-3-3)	0 to 95% no condensation
Weight	approx. 240 g (0.53 lbs)
Dimensions	97.5 x 93 x 71 mm (WxHxD) 3.8 x 3.7 x 2.8 inch (WxHxD)

Approvals / marking

Ex conformity in acc. with 2014/34EU:

Ex II 1G Ex ia IIC T5 Ga (-20°C ≤ Ta ≤ +45°C)

Ex II 1G Ex ia IIC T4 Ga (-20°C ≤ Ta ≤ +60°C)

Ex II 1D Ex ia IIIC T135°C Da (-20°C ≤ Ta ≤ +60°C)

Examination certificate:

BAS 02 ATEX 1290



Part no.: 912581

Analogue addressable manual call point for outdoor use in Ex zone 0 and 20. Provided for use on fire alarm control units with Loop AP protocol. Addressing via DIP switch, the address can also be modified after installation. Detector with intrinsically safe electronics for operation in areas with a risk of explosion. Connection only via an Ex Loop AP 24 V Ex security barrier.

Included in delivery

1 Key to reset / open the MCP

Connection / mounting

Connection cable 2-wire
Conductor cross-section max. 2.5 mm² (AWG 13)
Electrostatic shielding not required

Note

Analogue addressable detectors for explosive areas are to be used in the Loop AP branch. For this purpose the protocol interface is to be used.

Connection diagram

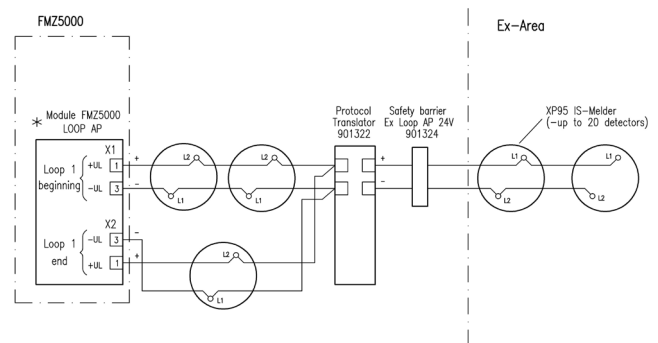

* It can either the module FMZ5000 LOOP AP (order-no. 902748) or the module FMZ5000 LOOP AP red. (order-no. 904484) can be used.



Manual call points

DMX outdoor application, conventional, Ex

dC 31 manual call point, red



Technical specifications

Function	Type B, latching contact
Technology	Conventional
Rated voltage	9 V
Operating voltage	7.6 V - 9.7 V DC
Quiescent current	5 mA (at 9 V)
Alarm current	20 mA (at 9 V)
IP rating (EN 60529)	IP 66
Enclosure material	PC
Color	RAL 3001, red
Trigger mechanism material	POM plastic
Operating temperature	-25 °C to +60 °C (-4 °F to +140 °F)
Storage temperature	-35 °C to +60 °C (-31 °F to +140 °F)
Relative humidity	0 to 95% no condensation
Specification according to	EN 54-11
Ex zones	1 (Gas) and 21 (Dust)
Weight	475 g (1.1 lbs)
Dimensions	135 x 161 x 61 mm (WxHxD) 5.3 x 6.3 x 2.4 inch (WxHxD)

Part no.: 908711

Conventional manual call point for outdoor areas in Ex zone 1 and 21 in accordance with EN 54-11. Designed for operation on conventional lines of the fire detection and suppression control panels FMZ 4100, FMZ 5000 and Clunid. The white inside sign can be replaced with other labels (see DMX outdoor application, accessories). Markings or labels which do not comply with the standard will void the VdS and EN 54-11 approvals.

Included in delivery

Mounting hardware
1 Door key
2 Cable glands M20 x 1.5
1 Blanking plug

Connection / mounting

Connection cable	2-wire
Recommended cable, standard	747180
J-Y(ST)Y-2x2x0.8 mm	
Recommended cable for circuit integrity	907940
JE-H(ST)H E30 2x2x0.8 mm	
Conductor cross-section	max. 2.5 mm ² (AWG 13)
Electrostatic shielding	not required

Note

An Ex barrier and the blue fire alarm cable are not required. Strong magnetic fields should be avoided in the vicinity of the detectors.

Approvals / marking

Ex conformity in acc. with 2014/34/EU

Ex II 2G Ex emb IIC T6 Gb
Ex II 2D Ex tb IIIC T80°C Db

Examination certificate:

BVS 09 ATEX E016 X



G 206113



0786-CPD-20309





Manual call points

DMX outdoor application, conventional, Ex



dC31 manual release, yellow

Technical specifications

Function	Type B, latching contact
Color	RAL 1021, yellow
Specification according to	EN 12094-3

Otherwise like part no. 908711

Markings or labels which do not comply with the standard will void the VdS and EN 12094-3 approvals.

dC31 emergency button, blue

Technical specifications

Function	Type B, non-latching contact
Color	RAL 5015, blue
Specification according to	EN 12094-3

Otherwise like part no. 908711

Markings or labels which do not comply with the standard will void the VdS and EN 12094-3 approvals.

dC31 2nd release, green

Technical specifications

Function	Type B, non-latching contact
Color	RAL 6002, green
Specification according to	similar to EN 12094-3

Otherwise like part no. 908711

Markings or labels which do not comply with the standard will void the VdS approval.

Part no.: 908712

Approvals / marking

Ex conformity in acc. with 94/9/EC

Ex II 2G Ex emb IIC T6 Gb
Ex II 2D Ex tb IIIC T80°C Db
BVS 09 ATEX E016 X

Examination certificate:



G 207079



0786-CPD-20310



Note

Please select the label text of the MCP when ordering

Part no.: 908713

Approvals / marking

Ex conformity in acc. with 94/9/EC

Ex II 2G Ex emb IIC T6 Gb
Ex II 2D Ex tb IIIC T80°C Db
BVS 09 ATEX E016 X

Examination certificate:



G 207099



0786-CPD-20311



Note

Please select the label text of the MCP when ordering

Part no.: 908714

The outside sign is as specified by VdS 2496 Issue 12.96.

Approvals / marking

Ex conformity in acc. with 94/9/EC

Ex II 2G Ex emb IIC T6 Gb
Ex II 2D Ex tb IIIC T80°C Db
BVS 09 ATEX E016 X

Examination certificate:



G 207099



Note

Please select the label text of the MCP when ordering.



Manual call points

DMX outdoor application, accessories

Mounting plate DMX3100
cpl. switch 2R

Part no.: 907883

Mounting plate DMX3100 2GRU
cpl. switch 2R

Part no.: 907887

Sign DMX3100 special lettering

Part no.: 907192

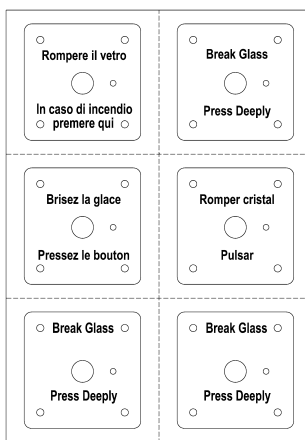



Manual call points

DMX accessories, general

"D" shape door key

Part no.: 173881 (PU 10 pcs.)

Reset key DMX-SA

Part no.: 934554 (PU 10 pcs.)

Reset key KAX

Part no.: 934555 (PU 10 pcs.)

Glass sheet DMX3000

Part no.: 903563 (PU 10 pcs.)

Glass sheet DMX3100

Part no.: 934559 (PU 10 pcs.)

Glass sheet KAX Discovery

Part no.: 912567 (PU 10 pcs.)



Standard detectors

Chapter 06

The contents of this publication are subject to modifications without notice. All rights reserved.

Trusted above all.

Viking GmbH | Industriestr. 10/12 | D-23840 Bad Oldesloe | www.viking-emea.com





Standard detectors

General information



Loop detectors and modules

The detector series offers ionisation smoke detectors, optical smoke detectors, heat detectors and multisensor detectors, communicating with the FMZ 5000 with a Loop AP module. The series is supplemented by manual call points, modules, isolators and other loop nodes.

Every product responds to queries and control commands from the fire alarm panels. It communicates with the fire alarm panel about the status, type and position as well as external commands and other information contributing to the alarm status. The signals are also checked for errors. For some detectors five different operating modes are available which can be selected via the fire alarm panel. Each operating mode has a specific response behaviour which corresponds to the fire criteria to be expected.

Conventional detectors

Conventional detectors with a wide range of supply voltages.

The interactive loop detectors define a new standard in reliable fire detection. Highly developed software algorithms and strongly expanded functionalities set new standards. Fire characteristics are selected in such a way that a fire will be safely detected.

The various options for the individual adjustment of the detector sensitivity and several setup modes dependent on the time of day guarantee the optimum detector adjustment to the area being monitored.

With these performance characteristics all safety concepts can be implemented and ensure maximum customer benefit:

- five detector sensitivity stages/algorithms for each application (for the standard loop detectors)
- detector sensitivity that can be switched according to environmental conditions depending on the time of day (for the standard loop detectors)
- automatic drift compensation of the measuring system for constant sensitivity over the whole period of application
- automatic contamination detection and early maintenance indication for the efficient deployment of maintenance personnel
- automatic function monitoring including sensor technology for greatest availability
- safe operation due to emergency running characteristics during a potential processor failure
- non-volatile memory, e.g. date of commissioning, last service, reference number, value of the drift compensation

A variety of detector installation bases and numerous modules for adding contacts and issuing signals complete this system. Visual and acoustic signal transmitters can also be switched directly on the loop to issue alarms.



Standard detectors

Optical smoke detectors, addressable

Optical smoke detector OMX95



Product features

- Constant function monitoring of the sensors, software and hardware including the microcontroller
- Non-volatile memory for detector data
- Day/night switching via fire alarm panel with different sensitivities

Technical specifications

Detection method	Infrared photo diode
Technology / protocol	Loop AP / Discovery
Integrated isolator	no
Operating voltage	17 V - 28 V DC
Quiescent current	0.44 mA
Alarm current	3.4 mA
Alarm indication	2 red LEDs
Operating temperature	-40 °C to +70 °C (-40 °F to 158 °F)
IP rating (EN 60529)	IP 44
Enclosure material	white polycarbonate
Relative humidity	0 to 95% no condensation
Specification according to	EN 54-7
Weight	105 g (0.2 lbs)
Dimensions	100 x 42 mm (dia. x H) 3.9 x 1.7 inch (dia.xH)

Part no.: 907541

Analog addressable optical smoke detector. Designed for use in areas where only low false alarm sources can be expected. Applicable for operation in fire alarm panel FMZ 5000/DCP-1 with Loop AP protocol. 5 sensitivity modes, adjustable via software control. Addressing via separate address card. The address can also be changed after installation.

Not included in delivery

Detector base see accessories
Address card ACX SA 8 925988

Connection / mounting

Connection cable 2-wire
Recommended cable, standard 747180
J-Y(ST)Y-2x2x0.8 mm
Conductor cross-section max. 2.5 mm² (AWG 13)
Electrostatic shielding not required

Sensitivity modes

	smoke	t _{min} alarm
1	1.4 % / m (39.4 inch)	5 s
2	1.4 % / m (39.4 inch)	30 s
3	2.1 % / m (39.4 inch)	5 s
4	2.1 % / m (39.4 inch)	30 s
5	2.8 % / m (39.4 inch)	5 s

Note

The response sensitivity must be adjusted to the environmental conditions. The settings can be changed at any time.

Approvals / marking



G 208033



2531-CPR-CSP10944



Optical smoke detector OMX95 SIL

Part no.: 927182

Otherwise like part no. 907541

Approvals / marking



2531-CPR-CSP10942

ESC (SIL2)



Standard detectors

Optical smoke detectors, addressable

Optical smoke detector OMX SA-I



Product features

- Extremely dark smoke chamber with surface-mounted IR-transmitter and prism
- Photo-diode and amplifier integrated
- Integrated Isolator
- Drift compensation
- Tri-color LED status indicator
- Continuous function monitoring of the sensors, soft- and hardware including the microcontrollers
- Day/night switching via fire alarm panel with different sensitivities

Technical descriptions

Detection method	Optical scattering principle
Technology/protocol	Loop AP / Discovery * CoreProtocol ® **
Measuring frequency	1 per s
Integrated isolator	yes
Operating voltage	17 V - 35 V DC
Quiescent current	0.35 mA
Starting current	0.58 mA
Alarm current	3.5 mA
LED status:	
Alarm	red
Fault	yellow, flashing
Short circuit	yellow
Status request by FACP	green **
Operating temperature	-40 °C to +70 °C (-40 °F to +158 °F)
IP rating (EN 60529)	IP 44
Material enclosure	Polycarbonate white
Relative humidity	0 to 95% no condensation
Specification	EN 54-7, EN 54-17
Weight	83 g (0.18 lbs)
Dimensions	100 x 36 mm (DxH) 3.94 x 1.42 inch (DxH) (Height with detector base 48 mm (1.89 inch))

* Protocol with FMZ 5000 / DCP-1

**Not with FMZ 5000 / DCP-1

Part no.: 925970

Analog addressable optical smoke detector. Designed for use in swelling fires or fires with strong smoke development. New sensor technology reduces false alarms and increases reliability in detecting real fires. Designed for operation on fire alarm control panels with Loop AP protocol. Five sensitivity levels adjustable via software control. Isolator is integrated in electronics. Addressing via separate address card. The address can also be changed after installation.

Not included in delivery

Detector base BAX SA 200	925973
Address card ACX SA 8	925988

Sensitivity modes

	smoke	t _{min} alarm
1	1.4 % / m	5 s
2	1.4 % / m	30 s
3	2.1 % / m	5 s
4	2.1 % / m	30 s
5	2.4 % / m	5 s

Note

The response sensitivity must be adjusted to the environmental conditions.

Approvals / marking



G 218043



2531-CPR-CSP10986



Standard detectors

Optical smoke detectors, addressable

Optical smoke detector OMX SA-I UL



Product features

- Extremely dark smoke chamber with surface-mounted IR-transmitter and prism
- Photo-diode and amplifier integrated
- Integrated Isolator
- Drift compensation
- Tri-color LED status indicator
- Continuous function monitoring of the sensors, soft- and hardware including the microcontrollers
- Day/night switching via fire alarm panel with different sensitivities

Technical descriptions

Detection method	Optical scattering principle
Technology/protocol	Discovery * CoreProtocol ® **
Measuring frequency	1 per s
Integrated isolator	yes
Operating voltage	17 V - 28 V DC
Quiescent current	0.5 mA
Staring current	1.0 mA
Alarm current	4.0 mA
LED status:	
Alarm	red
Fault	yellow, flashing
Short circuit	yellow
Status request by FACP	green **
Operating temperature	0 °C to +55 °C 32 °F to 131 °F
IP rating (EN 60529)	IP 44
Material enclosure	Polycarbonate white
Relative humidity	0 to 95% no condensation
Specification	UL268 7th Edition, CSFM, ULC 5529, FM3230
Weight	83 g (0.18 lbs)
Dimensions	100 x 36 mm (DxH) 3.94 x 1.42 inch (DxH) (Height with detector base 48 mm (1.89 inch))

* Protocol with FMZ 5000 / DCP-1

**Not with FMZ 5000 / DCP-1

Part no.: 4005621

Analog addressable optical smoke detector. Designed for use in swelling fires or fires with strong smoke development. New sensor technology reduces false alarms and increases reliability in detecting real fires. Designed for operation on fire alarm control panels with Loop AP. Isolator is integrated in electronics. Addressing via separate address card. The address can also be changed after installation.

Not included in delivery

Detector base BAX SA 210 UL
Address card ACX SA 8

4004706
925988

Note

Sensitivity: 1.2 - 2.1 %/ft

Approvals / marking





Standard detectors

Ionisation smoke detectors, addressable

Ionization smoke detector IMX95



Product features

- Constant function monitoring of the sensors, software and hardware including the microcontroller
- Non-volatile memory for detector data
- Day/night switching via fire alarm panel with different sensitivities

Technical specifications

Detection method	Ionization chamber
Technology / protocol	Loop AP / Discovery
Integrated isolator	no
Radioactive isotope	Americium 241
Radioactivity	33.3 kBq
Air velocity	max. 2 m (78.7 inch)/s continuously max. 10 m (394 inch)/s temporarily
Atmospheric pressure	equivalent to 600 m (0.37 miles) above MSL max.
Operating voltage	17 V - 28 V DC
Quiescent current	0.38 mA
Alarm current	3.4 mA
Alarm indication	2 red LEDs
Operating temperature	-30 °C to +70 °C (-22°F to +158 °F)
IP rating (EN 60529)	IP 44
Enclosure material	white polycarbonate
Relative humidity	max. 95% no condensation
Specification according to	EN 54-7
Weight	105 g (0.2 lbs)
Dimensions	100 x 42 mm (dia. x H) 3.9 x 1.7 inch (dia. x H)

Part no.: 907544

Analog addressable ionisation smoke detector. Designed for use in areas where occasional low dust can be expected. Applicable for operation in fire alarm panel with Loop AP protocol. 5 sensitivity modes, adjustable via software control. Addressing via separate address card. The address can also be changed after installation.

Not included in delivery

Detector base see accessories
Address card ACX SA 8 925988

Connection / mounting

Connection cable 2-wire
Recommended cable, standard 747180
J-Y(ST)Y-2x2x0.8 mm
Conductor cross-section max. 2.5 mm² (AWG 13)
Electrostatic shielding not required

Sensitivity modes

	Smoke value	t _{min} alarm
1	y = 0.45	5 s
2	y = 0.45	30 s
3	y = 0.70	5 s
4	y = 0.70	30 s
5	y = 1.00	5 s

Note

The response sensitivity must be adjusted to the environmental conditions. The settings can be changed at any time. The detector contains radioactive materials. The operating instructions and current laws and relating to radiation protection must be observed.

Approvals / marking



G 208036



2531-CPR-CSP10941



Standard detectors

Multisensor detectors, addressable

Multisensor detector OWMX SA-I



Product features

- Two thermistors
- Two heat sensors
- Photo-diode and amplifier integrated
- Integrated isolator
- Drift compensation
- Tri-color LED status indicator
- Constant function monitoring of the sensors, software and hardware including the microcontroller
- Day/night switching via fire detection panel with different sensitivities

Technical specifications

Detection methods	Optical scattered light principle, Thermistors
Technology / protocol	Loop AP / Discovery* CoreProtocol® **
Integrated isolator	yes
Operating voltage	17 V - 35 V DC
Quiescent current	0.35 mA
Starting current	0.56 mA
Alarm current	3.5 mA
Alarm indication	2 red LEDs
LED-Status:	
Alarm	red
Fault	yellow, flashing
Short circuit current	yellow
Status request by fire alarm panel	green **
Operating temperature	-40 °C to +70 °C (- 40 °F to +158 °F)
IP rating (EN 60529)	IP 54
Enclosure material	Polycarbonate white
Relative humidity	0 to 95% no condensation
Specification acc. to	EN 54-5, EN 54-7, EN 54-17
Weight	83 g (0.18 lbs)
Dimensions	100 x 50 mm (DxH) 3.9 x 1.5 inch (DxH) Height with detector base 40.5 mm (1.59 inch)

* Protocol with FMZ 5000 / DCP-1

**Not with FMZ 5000 / DCP-1

Part no.: 925972

Analog addressable optical-thermal multi-sensor detector with two lateral thermistors, applicable as universal heat or smoke detector. New sensor technology reduces false alarms and increases reliability in detecting real fires. Intended for operation with fire alarm control panels with Loop AP protocol. Five sensitivity modes, adjustable via software control. Addressing via separate address card. The address can also be changed after installation.

Not included in delivery

Detector base BAX SA 200	925973
Address card ACX SA 8	925988

Sensitivity modes

	Smoke	t _{min} Alarm	Heat sensor threshold value
1	1,1 % / m	20 s	increase >15°C
2	2,1 % / m	30 s	-
3	2,8 % / m	20 s	increase >21°C
4	4,2 % / m	20 s	increase >15°C
5	-	20 s	A1R

Note

The response sensitivity must be adjusted to the ambient conditions.

Approvals / marking



G 218041



2531-CPR-CSP10990



Standard detectors

Multisensor detectors, addressable

Multisensor detector OWMX SA-I UL



Product features

- Two thermistors
- Two heat sensors
- Photo-diode and amplifier integrated
- Integrated isolator
- Drift compensation
- Tri-color LED status indicator
- Constant function monitoring of the sensors, software and hardware including the microcontroller
- Day/night switching via fire alarm panel with different sensitivities

Technical specifications

Detection methods	Optical scattered light principle, Thermistors
Technology / protocol	Loop AP / Discovery* CoreProtocol® **
Measuring frequency	1 per s
Integrated isolator	yes
Operating voltage	17 V - 28 V DC
Monitoring current	0.5 mA
Starting current	1 mA
Alarm current	4 mA
LED-Status:	
Alarm	red
Fault	yellow, flashing
Short circuit current	yellow
Status request by fire alarm panel	green **
Operating temperature	0 °C to + 55 °C (-32 °F to + 131 °F)
IP rating (EN 60529)	IP 44
Enclosure material	Polycarbonate white
Relative humidity	0 to 95% no condensation
Specification acc. to	UL 268 7th Edition, UL 521, ULC S529, ULC S530, FM 3210
Weight	83 g (0.18 lbs)
Dimensions	100 x 38.5 mm (DxH) 3.9 x 1.52 inch (DxH) Height with detector base 50.5 mm (1.99 inch)

* Protocol with FMZ 5000 / DCP-1

**Not with FMZ 5000 / DCP-1

Part no.: 4005622

Analog addressable optical-thermal multi-sensor detector with two lateral thermistors, applicable as universal heat or smoke detector. New sensor technology reduces false alarms and increases reliability in detecting real fires. Designed for operation with fire alarm control panels with Loop AP protocol. Three operating modes, adjustable via software control. Addressing via separate address card. The address can also be changed after installation.

Not included in delivery

Detector base BAX SA 210 UL
Address card ACX SA 8

4004706
925988

Operating modes

Mode	Reaction
1, 3, 4	Multi criteria
2	only optical
5	only thermal

Note

Response sensitivity: 1.2 - 2.1 %/ft

Approvals / marking





Standard detectors

Multisensor detectors, addressable

Multisensor detector OWMX95 SIL



Part no.: 927184

Analog addressable multi-sensor detector consisting of the combination of an optical smoke detector and a heat detector. Designed for use in areas where regularly occurring sources of deception are to be expected. 5 sensitivity levels adjustable by software control. Addressing via separate addressing card. Address can be changed even after installation.

Note

Operation exclusively on SIL-certified fire alarm control panel with Loop AP protocol.

Not included in delivery

Detector base

see accessories

Address card ACX SA 8

925988

Approvals / marking

Spezification acc. to EN 54-5, EN 54-7

 2531-CPR-CSP10946 ESC (SIL2)



Standard detectors

Heat detectors, addressable

Heat detector WMX95



Product features

- Constant function monitoring of the sensors, software and hardware including the microcontroller
- Non-volatile memory for detector data
- Day/night switching via fire alarm panel with different sensitivities

Technical specifications

Detection method	NTC temperature sensor
Technology / protocol	Loop AP / Discovery
Integrated isolator	no
Response categories	A1R, A2, A2S
Temperature ranges	CR, CS
Operating voltage	17 V - 28 V DC
Quiescent current	0.35 mA
Alarm current	3.4 mA
Alarm indication	2 red LEDs
Response temperature	+54 °C to +100 °C (+129.2 °F to +212 °F)
Operating temperature	-40 °C to +80 °C (-40 °F to +176 °F)
IP rating (EN 60529)	IP 54
Enclosure material	Polycarbonate, white
Relative humidity	0 to 95% no condensation
Specification according to	EN 54-5
Weight	105 g (0.2 lbs)
Dimensions	100 x 42 mm (dia. x H) 3.9 x 1.7 inch (dia. x H)

Part no.: 907542

Analogue addressable rate-of-rise and maximum heat detector for use in areas where interference variables like smoke can be expected (e.g. office/storage areas, industrial plants or test stands). Applicable for operation in fire alarm panels FMZ 5000 with Loop AP protocol. 3 response classes in accordance with EN 54-5 and 2 temperature ranges adjustable via software control. Addressing via separate address card. The address can also be changed after installation.

Not included in delivery

Detector base see accessories
Address card ACX SA 8 925988

Connection / mounting

Connection cable 2-wire
Recommended cable, standard 747180
J-Y(ST)Y-2x2x0.8 mm
Conductor cross-section max. 2.5 mm² (AWG 13)
Electrostatic shielding not required

Sensitivity modes

	Category	Temperature
1	A1R	54 °C (129 °F) to 65 °C (149 °F)
2	A2	54 °C (129 °F) to 70 °C (158 °F)
3	A2S	54 °C (129 °F) to 70 °C (158 °F)
4	CR	84 °C (129 °F) to 100 °C (212 °F)
5	CS	84 °C (129 °F) to 100 °C (212 °F)

Note

The response sensitivity must be adjusted to the environmental conditions. The settings can be changed at any time.

Approvals / marking



G 208035



2531-CPR-CPS10937



Heat detector WMX95 SIL

Part no.: 927183

Otherwise like part no. 907542

Approvals / Marking



2531-CPR-CSP10936

ESC (SIL2)



Standard detectors

Multisensor detectors, addressable

Multisensor detector OWMX95



Product features

- Constant function monitoring of the sensors, software and hardware including the microcontroller
- Non-volatile memory for detector data
- Day/night switching via fire alarm panel with different sensitivities

Technical specifications

Smoke detection method	Infrared photo diode
Heat detection method	NTC temperature sensor
Technology / protocol	Loop AP / Discovery
Integrated isolator	no
Operating voltage	17 V - 28 V DC
Quiescent current	0.47 mA
Alarm current	3.5 mA
Alarm indication	2 red LEDs
Operating temperature	-30 °C to +70 °C (-22 °F to +158 °F)
IP rating (EN 60529)	IP 44
Enclosure material	white polycarbonate
Relative humidity	0 to 95% no condensation
Specification according to	EN 54 -5, 54-7
Weight	105 g (0.2 lbs)
Dimensions	100 x 50 mm (dia. x H) 3.9 x 2 inch (dia.xH)

Part no.: 907543

Analog addressable multisensor detector consisting of a combination of an optical smoke detector and a heat detector. Designed for use in areas where regular false alarm sources can be expected. Intended for operation in fire alarm panels with Loop AP protocol. 5 sensitivity modes, adjustable via software control. Addressing via separate address card. The address can also be changed after installation.

Not included in delivery

Detector base see accessories
Address card ACX SA 8 925988

Connection / mounting

Connection cable 2-wire
Recommended cable, standard 747180
J-Y(ST)Y-2x2x0.8 mm
Conductor cross-section max. 2.5 mm² (AWG 13)
Electrostatic shielding not required

Sensitivity modes

	Smoke	Heat	Trigger type	t _{min} Alarm
1	1.1 % / m (39 inch)	high	Multisensor	20 s
2	2.1 % / m (39 inch)	no response	Optical	30 s
3	2.8 % / m (39 inch)	low	Multisensor	20 s
4	4.2 % / m (39 inch)	high	Multisensor	20 s
5	no response	Category A1	A1 heat detector	30 s

Note

The response sensitivity must be adjusted to the ambient conditions. The settings can be changed at any time. When using the detector in mode 5 the number of max. permitted monitoring areas for heat detectors must not be exceeded.

Approvals / marking



G 208034



2531-CPR-CSP10948



Multisensor detector OWMX95 SIL

Part no: 927184

Otherwise like part no. 907543

Approvals / marking



2531-CPR-CSP10946

ESC (SIL2)

Trusted above all.

Viking GmbH | Industriestr. 10/12 | D-23840 Bad Oldesloe | www.viking-emea.com





Standard detectors

Heat detectors, addressable

Heat detector WMX SA-1



Product features

- Two lateral thermistores
- Integrated isolator
- Tri-color LED status indicator
- Constant function monitoring of the sensors, software and hardware including the microcontroller
- Day/night switching via fire alarm panel with different sensitivities

Technical specifications

Detection method	Temperature-dependent resistance
Technology/protocol	Loop AP / Discovery * CoreProtocol® **
Measurement frequency	1 per s
Integrated isolator	yes
Operating voltage	17 V - 35 V DC
Quiescent current	0.35 mA
Starting current	0.56 mA
Alarm current	3.5 mA
LED status:	
Alarm	red
Fault	yellow flashing
Short circuit	yellow
Status request by FACP	green **
Operating temperature	-40 °C to +70 °C (-40 °F to +158 °F)
IP rating (EN 60529)	IP 54
Material enclosure	Polycarbonate white
Relative humidity	0 to 95% no condensation
Specification	EN 54-5, EN 54-17
Weight	83 g (0.18 lbs)
Dimensions	100 x 38.5 mm (DxH) (3.94 x 1.52 inch (DxH) (Height with detector base 40.5 mm (1.59 inch))

* Protocol with FMZ 5000 / DCP-1

**Not with FMZ 5000 / DCP-1

Part no.: 925971

Analog addressable heat detector with two lateral thermistors. Designed for use as differential or maximum detector. Use as differential detector e.g. in rooms with constant low ambient temperature. Use as maximum detector in rooms, where temperature variations are to be expected. Designed for operation on fire alarm control panels with Loop AP protocol. Three sensitivity levels and two temperature ranges adjustable via software control. Addressing via separate address card. The address can also be changed after installation.

Not included in delivery

Detector base BAX SA 200	925973
Address card ACX SA 8	925988

Note

The response sensitivity must be adjusted to the environmental conditions.

Sensitivity modes

Mode	Response category	Application temp. °C		Stat. response temp. °C		
		typ.	max.	min.	typ.	max.
1	A1R	25	50	54	57	65
2	A2R	25	50	54	60	70
3	A2S	25	50	54	60	70
4	CR	55	80	84	90	100
5	CS	55	80	84	90	100

Approvals / markings



G 218042



2531-CPR-CSP10982



Standard detectors

Heat detectors, addressable

Heat detector WMX SA UL



Product features

- Constant function monitoring of the sensors, software and hardware including the microcontroller
- Day/night switching via fire alarm panel with different sensitivities possible

Technical specifications

Detection method	Thermistor
Technology/protocol	Loop AP / Discovery * CoreProtocol® **
Integrated isolator	no
Operating voltage	17 V - 28 V DC
Monitoring current	0.5 mA
Starting current	1 mA
Alarm current	3.5 mA
Alarm indication	2 LED red
Response temperature	57 °C to 100 °C (135 °F to 212 °F)
Operating temperature	0 °C to +66 °C (32 °F to +151 °F)
Material enclosure	Polycarbonate white
Relative humidity	0 to 95% no condensation
Specification	UL 521
Weight	104 g (0.23 lbs)
Dimensions	100 x 42 mm (DxH) (3.94 x 1.65 inch (DxH) (Height with detector base 54 mm (2.12 inch))

* Protocol with FMZ 5000 / DCP-1

**Not with FMZ 5000 / DCP-1

Part no.: 4005623

Analog addressable heat detector. Designed for use as differential or maximum detector. Monitors temperature by means of a single thermistor that provides a voltage output proportional to the outside air temperature. Addressing via separate address card. The address can also be changed after installation.

Not included in delivery

Detector base BAX SA 210 4004706
Address card ACX SA 8 925988

Mode	UL heat classification @ 55 counts alarm
1	57 °C (135 °F) fixed temperature and rate of rise
2	66 °C (150 °F) fixed temperature and rate of rise
3	66 °C (150 °F) fixed temperature
4	93 °C (200 °F) fixed temperature and rate of rise
5	93 °C (200 °F) fixed temperature

Note

The five response modes correspond to the five classes as defined in UL 268. All modes include a fixed temperature response defined in the standard by the static temperature. A count value of 55 corresponds to the alarm sensitivity level of EN 54.

Approvals / markings





Standard detectors

Heat detectors, addressable

Heat detector WMX95 SIL

Part no.: 927183



Analog addressable heat differential maximum detector for use in areas where disturbance variables such as smoke are to be expected (e.g. office or storage areas, industrial plants, test stands). The housing of the heat detector allows the temperature-sensitive sensor to flow easily around it due to its low air resistance. Three response classes and 2 temperature ranges adjustable by software control. Addressing via separate addressing card. The address can be changed even after installation.

Note

Operation exclusively on SIL-certified fire alarm control panel with Loop AP protocol.

Not included in delivery

Detector base

see accessories

Address card ACX SA 8

925988

Approvals / marking

Spezifikation acc. to EN 54-5



2531-CPR-CSP10936

ESC (SIL2)



Standard detectors

Detector accessories, addressable

Detector base BAX SA 200



Product features

- Compatible with MX95 and MX SA-I detectors
- Insulated sliding contact ensures power supply during temporary detector removal
- Easy installation

Technical specifications

Integrated isolator	no
	max. 2.5 mm ²
Material	Polycarbonate
Color	white
Weight	63 g (0.14 lbs)
Dimensions	100 x 20 mm (DxH) 3.94 x 0.79 inch (DxH)

Part no.: 925973

Detector base for MX95 and MX SA-I detectors. Address Card is included. Simple mounting of the detector base and easy insertion of the detectors by clockwise rotation with subsequent locking.

Included in delivery

Adapter base BAX SA 200 incl. Address Card.

Not included in delivery

Mounting material

Connection / mounting

Connection cable	2-wire
Recommended cable standard	747180
J-Y(ST)Y-2x2x0,8 mm	
Conductor cross-section	max. 2.5 mm ²
Electrostatic shielding	not required

Approvals / marking



Detector base BAX SA 210 UL



Part no.: 4004706

Detector base for all MX SA UL and MX SA-I UL detectors incl. Address card.

Otherwise like part no. 925973

Approvals / markings



Address Card ACX SA 8



Part no.: 925988

Universal Address card for Detector base BAX SA 200, BAX 210, BAX 210 UL, BAX 284 I and BAX 215 Ex for use with use with Loop detectors of Apollo series XP95, Discovery and Soteria, blank. PU 100 pcs.



Standard detectors

Detector accessories, addressable

Detector base BAX 210



Technical specifications

Material	PC
Integrated isolator	no
Color	white
Ambient temperature	-20 °C to +70 °C (-4 °F to +158 °F)
Weight	55 g (0.1 lbs)
Dimensions	100 x 8 mm (dia. x H) 3.9 x 0.3 inch (dia. x H)

Part no.: 901289

Base for all Loop AP detectors including address card with large-size contact screws for all connections. Easy assembly and simple insertion of the detectors by clockwise rotation and lock. A terminal for a detector remote indicator is available.

Included in delivery

1 detector base in standard design including address card 1 to 126

Not included in delivery

Mounting hardware

Approvals / marking



Detector base BAX 284 I



Technical specifications

Material	PC
Integrated isolator	yes
Fault indication	yellow LED
Color	white
Ambient temperature	-20 °C to +60 °C (-4 °F to +140 °F)
Weight	100 g (0.2 lbs)
Dimensions	100 x 24 mm (dia. x H) 3.9 x 0.9 inch (dia. x H)

Part no.: 910790

Base for all Loop AP detectors including address card with dual isolator and large-size contact screws for all connections. For the separation of individual line sections in the event of short circuits in loop operation. Easy assembly and simple insertion of the detectors by clockwise rotation and lock. A terminal for a detector remote indicator is available.

Included in delivery

1 detector base in standard design including address card 1 to 126

Not included in delivery

Mounting hardware

Approvals / marking



G 210033



2531-CPR-CSP11176



Standard detectors

Detector accessories, addressable

Isolator base BAX 211



Technical specifications

Material	PC
Colour	white
Ambient temperature	-20 °C to +60 °C (-4 °F to +140 °F)
Weight	55 g (0.1 lbs)
Dimensions	100 x 23 mm (dia. x H) 3.9 x 0.9 inch (dia. x H)

Part no.: 901294

Base for the ISX 720 I isolator with large-size contact screws for all connections. Easy assembly and simple insertion of the isolator by clockwise rotation and lock.

Included in delivery

1 Isolator base in standard design

Not included in delivery

Mounting hardware
Isolator ISX 720

901293

Approvals / marking



Isolator ISX 720 I



Technical specifications

Material	PC
Fault indication	yellow LED
IP rating (EN 60529)	IP 43
Colour	white
Ambient temperature	-20 °C to +60 °C (-4 °F to +140 °F)
Weight	75 g (0.2 lbs)
Dimensions	100 x 25 mm (dia. x H) 3.9 x 1 inch (dia. x H)

Part no.: 901293

Loop AP isolator for the separation of individual line sections in the event of short circuits in loop operation. Easy assembly and simple insertion of the isolator in the matching base by means of clockwise rotation and lock.

Included in delivery

1 Isolator for use in isolator base BAX 211

Approvals / marking



G 200083



2531-CPR-CSP11142



Standard detectors

Detector accessories, addressable

Isolator ISX 284 R

Part no.: 914137

Loop AP isolator for the separation of individual line sections in the event of short circuits in loop operation. Easy assembly for mounting on a mounting rail.

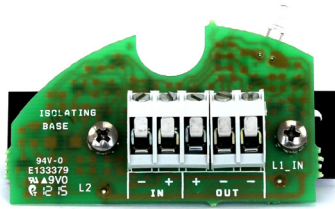

Included in delivery

1 isolator for mounting on a mounting rail

Approvals / marking



Technical specifications

Fault indication	yellow LED
Ambient temperature	- 20 °C to + 60 °C (-4 °F to +140 °F)
Weight	20 g
Dimensions	63 x 38.8 x 43 mm (BxHxT)



Standard detectors

Detector accessories, addressable

Isolator XP95 IP 65, complete



Part no.: 905702

Isolator for the separation of individual line sections during short circuit in loop AP in robust design. Easy assembly and simple insertion of the isolator with base in the additional enclosure for industrial applications.

Included in delivery

1 Housing Abox 100	905711
1 Mounting plate, complete	908422
1 Isolator ISX 720	901293
1 Isolator base BAX 211	901294

Not included in delivery

Mounting hardware

Technical specifications

Material	PC
IP rating (EN 60529)	IP 65
Color lower enclosure section	grey
Color upper enclosure section	red
Ambient temperature	-20 °C to +60 °C (-4 °F to +140 °F)
Weight	340 g (0.8 lbs)
Dimensions	140 x 140 x 70 mm (WxHxD) 5.5 x 5.5 x 2.8 inch (WxHxD)



Standard detectors

Optical smoke detectors, addressable, Ex

Optical smoke detector OMX95 Ex



Product features

- Constant function monitoring of the sensors, software and hardware including the microcontroller
- Detector for use in zone 0

Technical specifications

Detection method	Infrared photo diode
Technology / protocol	Loop AP / XP95
Integrated isolator	no
Operating voltage	14 V - 22 V DC
Quiescent current	0.34 mA
Alarm current	1 mA
Operating temperature, T4	-20 °C to +60 °C (-4 °F to +140 °F)
Operating temperature, T5	-20 °C to +45 °C (-4 °F to +113 °F)
Enclosure material	white polycarbonate
Relative humidity	0 to 95% no condensation
Specification to	EN 54-7:2018
Weight	105 g (0.2 lbs)
Dimensions	100 x 42 mm (DxH) 3.9 x 1.7 inch (DxH)

Part no.: 901318

Analog addressable optical smoke detector for Ex zone 0 designed for use in areas where only low false alarm sources can be expected. Provided for operation on fire alarm control panels with Loop AP protocol. Addressing via separate address card. The address can also be changed after installation. Detector with intrinsically safe electronics for operation in hazardous areas. Connection only via a safety barrier Ex Loop AP 24 V and a protocol interface Loop AP.

Not included in delivery

Detector base	see accessories
Address card ACX SA 8	925988
Safety barrier Ex Loop AP 24 V	901324
Protocol interface Loop AP	901322

Connection / mounting

Connection cable	2-wire
Recommended cable	747180
J-Y(ST)Y-2x2x0.8 mm	
Conductor cross-section	max. 2.5 mm ² (AWG 13)
Electrostatic shielding	not required

Note

Analog addressable detector for hazardous areas are to be connected to a spur of the Loop AP. The protocol interface and the safety barrier Ex Loop AP have to be used.

Approvals / marking

Ex conformity in acc. with 2014/34/EU

- ⊕ II 1G Ex ia IIC T5 Ga (-20°C ≤ Ta ≤ +45°C)
- ⊕ II 1G Ex ia IIC T4 Ga (-20°C ≤ Ta ≤ +60°C)

EC type approval certificate:

BAS 02 ATEX 1289



2531-CPR-CSP10929





Standard detectors

Heat detectors, addressable, Ex

Heat detector WMX95 Ex



Product features

- Constant function monitoring of the sensors, software and hardware including the microcontroller
- Detector for use in Zone 0

Technical specifications

Detection method	NTC-temperature sensor
Technology / protocol	Loop AP / XP95
Integrated isolator	no
Operating voltage	14 V - 22 V DC
Quiescent current	0.3 mA
Alarm current	1.3 mA
Response category	A2S
Alarm indication	1 LED red
Activating temperature	approx. +60 °C (+140 °F)
Operating temperature, T4	-20 °C to +60 °C (-4 °F to +140 °F)
Operating temperature, T5	-20 °C to +40 °C (-4 °F to +104 °F)
Enclosure material	Polycarbonate, white
Relative humidity	max. 95% no condensation
Specification according to	EN 54-5
Weight	105 g (0.2 lbs)
Dimensions	100 x 42 mm (DxH) 3.9 x 1.7 inch (DxH)

Part no.: 901319

Analog addressable maximum and rate-of-rise heat detector for Ex zone 0 for use in areas in which interference such as smoke are likely to be encountered (e.g. office- and storage areas, industrial plant or test facilities). Provided for use on fire alarm control panels with Loop AP protocol. Addressing via separate address card. The address can also be changed after installation. Detector with intrinsically safe electronics for operation in hazardous areas. Connection only via an Ex Loop AP 24 V safety barrier and a protocol interface Loop AP.

Not included in delivery

Detector base	see accessories
Address card ACX SA 8	925988
Safety barrier Ex standard	901324
Loop AP protocol interface	901322

Connection / mounting

Connection cable	2-wire
Recommended cable, standard	747180
J-Y(ST)Y-2x2x0.8 mm	
Conductor cross-section	max. 2.5 mm ² (AWG 13)
Electrostatic shielding	not required

Note

Analog addressable detectors for hazardous areas are to be connected to a spur of the Loop AP. The protocol interface and Ex Loop AP safety barrier have to be used.

Approvals / marking

Ex conformity in acc. with 2014/34/EU

⊕ II 1G Ex ia IIC T5 Ga (-20°C ≤ Ta ≤ +45°C)
⊕ II 1G Ex ia IIC T4 Ga (-20°C ≤ Ta ≤ +60°C)

EC type approval certificate: BAS 02 ATEX 1289



G 216018



2531-CPR-CSP10920





Standard detectors

Ionisation smoke detectors, addressable, Ex

Ionization smoke detector IMX95 Ex



Product features

- Constant function monitoring of the sensors, software and hardware including the microcontroller
- Detector for use in zone 0

Technical specifications

Detection method	ionization chamber
Technology / protocol	Loop AP / XP95
Integrated isolator	no
Radioactive isotope	Americium 241
Radioactivity	33.3 kBq
Air velocity	max. 2 m (78.7 inch)/s continuously max. 10 m (394 inch)/s temporarily
Atmospheric pressure	corresponding to max. 600 m (0.37 miles) a.s.l.
Operating voltage	14 V - 22 V DC
Quiescent current	0.3 mA
Alarm indication	1 LED red
Operating temperature, T4	-20 °C to +60 °C (-4 °F to +140 °F)
Operating temperature, T5	-20 °C to +40 °C (-4 °F to +104 °F)
Enclosure material	white polycarbonate
Relative humidity	max. 95% no condensation
Specification according to	EN 54 Part 7
Weight	105 g (0.2 lbs)
Dimensions	100 x 42 mm (DxH) 3.9 x 1.7 inch (DxH)

Part no.: 901317

Analog addressable ionization smoke detector for Ex zone 0 designed for use in areas where occasionally low dust can be expected. Provided for use on fire alarm control panels with Loop AP protocol. Addressing via separate address card. The address can also be changed after installation. Detector with intrinsically safe electronics for operation in hazardous areas. Connection only via an Ex Loop AP 24 V safety barrier and a protocol interface Loop AP.

Not included in delivery

Detector base	see accessories
Address card ACX SA 8	925988
Safety barrier Ex standard	901324
Loop AP protocol interface	901322

Connection / mounting

Connection cable	2-wire
Recommended cable, standard	747180
J-Y(ST)Y-2x2x0.8 mm	
Conductor cross-section	max. 2.5 mm ² (AWG 13)
Electrostatic shielding	not required

Note

Analog addressable detectors for hazardous areas are to be connected to a spur of the Loop AP. The protocol interface and the safety barrier Ex Loop AP have to be used. The detector contains radioactive materials. The operating instructions, current laws and regulations on radiation protection must be observed.

Approvals / marking

Ex conformity in acc. with 2014/34/EU

II 1G Ex ia IIC T5 Ga (-20°C ≤ Ta ≤ +45°C)

II 1G Ex ia IIC T4 Ga (-20°C ≤ Ta ≤ +60°C)

EC type approval certificate: BAS 02 ATEX 1289



G 216019



2531-CPR-CSP10923





Standard detectors

Detector accessories, addressable, Ex

Detector base BAX 215 Ex



Technical specifications

Material	PC
Integrated isolator	no
Color	white
Operating temperature, T4	-20 °C to +60 °C (-4 °F to +140 °F)
Operating temperature, T5	-20 °C to + 45 °C (-4 °F to +113 °F)
Weight	55 g (0.1 lbs)
Dimensions	100 x 8 mm (DxH) 3.9 x 0.3 inch (DxH)

Part no.: 901320

Base for all analogue addressable Ex-detectors including address card with large size contact screws for all connections. Simple mounting and easy insertion of detectors by clockwise rotation and lock. Base for use in areas with a risk of explosion. Connection only via an Ex Loop AP 24 V Ex safety barrier and protocol interface Loop AP.

Included in delivery

1 Detector base in the standard version
incl. address card from 1 to 126

Not included in delivery

Mounting materials

Approvals / marking

Ex conformity in acc. with 2014/34/EU

⊕ II 1G Ex ia IIC T5 Ga (-20°C ≤ Ta ≤ +45°C)
⊕ II 1G Ex ia IIC T4 Ga (-20°C ≤ Ta ≤ +60°C)

EC type approval certificate:

BAS 02 ATEX 1289





Standard detectors

Optical smoke detectors, conventional

Optical smoke detector OMX 1001C



Product features

- Constant function monitoring of sensors, software and hardware including the microcontroller
- Normal operation indication by green flashing light
- Automatic drift compensation
- Robust smoke detector

Technical specifications

Detection method	Infrared photo diode
Alarm threshold (light obscuration)	approx. 0.16 dB/m (39 inch)
Technology	conventional
Operating voltage	7.6 V - 13.2 V DC
Quiescent current	approx. 0.13 mA
Alarm current	approx. 18 mA
Alarm indication	1 LED red, permanent light
Normal operation indication	1 LED green, flashing light
Electrostatic shielding	recommended
Operating temperature	-20 °C to +60 °C (-4 °F to +140 °F)
IP rating (EN 60529)	IP 43, with membrane plug and sealing of the mounting holes
Enclosure material	white polycarbonate
Relative humidity	0 to 95% no condensation
Specification according to	EN 54-7
Weight	220 g (0.5 lbs)
Dimensions	113 x 68 mm (DxH) 4.5 x 2.7 inch (DxH)

Part no.: 800831

Conventional optical smoke detector. Designed for use in areas with smoke in case of fire. Robust smoke detector with drift compensation for use in industrial environments.

Not included in delivery

Detector base	see accessories
End of line-resistor 1.8 K / 0.5 W	675235
Dust cover	894760

Spare parts

Insert OMX (Can)	801023
Basket IMX (Dust-proof grid)	253250

Connection / mounting

Connection cable standard detector	2-wire
Remote indication	2-wire
Recommended cable	JY (St) Y 2x2x0.8 mm
Conductor cross-section	max. 2.5 mm ² (AWG 13)

Approvals / marking



G 200005



0786-CPR-20131





Standard detectors

Ionization smoke detectors, conventional

Ionization smoke detector IMX 1001E



Product features

- Drift compensation by dual ionization
- Robust smoke detector

Technical specifications

Detection method	Double ionization chamber
Technology	conventional
Operating voltage	7.6 V - 13.2 V DC
Quiescent current	approx. 0.08 mA
Alarm current	approx. 20 mA
Alarm indication	1 LED red
Sensitivity	$\gamma = 0.8$
Air flow	max. 5 m/s
Radioactivity Am241	2.8 kBq
Electrostatic shielding	recommended
Operating temperature	-20 °C to +60 °C (-4 °F to +140 °F)
IP rating (EN 60529)	IP 43, with membrane plug and sealing of the mounting holes
Enclosure material	Polycarbonate white
Relative humidity	max. 95% no condensation
Specification according to	EN 54-7
Weight	230 g (0.5 lbs)
Dimensions	113 x 68 mm (DxH) 4.5 x 2.7 inch (DxH)

Part no.: 754450

Conventional ionization smoke detector. Designed for use in areas with smoke in case of fire. Robust smoke detector with a dual ionization chamber for use in industrial environments.

Not included in delivery

Detector base	see accessories
End of line-resistor 1.8 K / 0.5 W	675235
Dust cover	894760

Connection / mounting

Connection cable standard detector	2-wire
Remote indication	2-wire
Recommended cable	JY (St) Y 2x2x0.8 mm
Conductor cross-section	max. 2.5 mm ² (AWG 13)

Note

The detector contains radioactive materials. The operating instructions and current laws and regulations on radiation protection must be observed.

Approvals / marking



G 28107



0786-CPR-20211



Ionization smoke detector IMX1001E S

Technical specifications

Sensitivity	$\gamma = 0,6$
-------------	----------------

Part no.: 758900

Conventional ionization smoke detector with increased sensitivity level.

Approvals / marking





Standard detectors

Heat detectors, conventional

Heat detector WMX 1000D60



Product features

- Adaptation to ambient temperature by 2 temperature sensors
- Combined rate-of-rise and static measurement
- Robust heat detector

Technical specifications

Detection method	NTC-temperature sensor
Response category	A1
Technology	conventional
Operating voltage	7.6 V - 13.2 V DC
Quiescent current	approx. 0.07 mA
Alarm current	approx. 15 mA
Alarm indication	1 LED red
Static threshold value	+54 °C to +62 °C (+129.2 °F to +143.9 °F)
Electrostatic shielding	not required
Operating temperature	-20 °C to +50 °C (-4 °F to +122 °F)
IP rating (EN 60529)	IP 23, with membrane plug and sealing of the mounting holes
Enclosure material	Polycarbonate, white
Relative humidity	max. 95% no condensation
Specification according to	EN 54-5
Weight	140 g (0.3 lbs)
Dimensions	113 x 68 mm (DxH) 4.5 x 2.7 inch (DxH)

Part no.: 747866

Conventional combined rate-of-rise and static heat detector. Designed for areas with rapid rise of temperature caused by flames. Robust heat detector with 2 temperature sensors for use in industrial environments.

Not included in delivery

Detector base	see accessories
End of line-resistor 1.8 K / 0.5 W	675235
Dust cover	894760

Connection / mounting

Connection cable standard detector	2-wire
Remote indication	2-wire
Recommended cable	JY (St) Y 2x2x0.8 mm
Conductor cross-section	max. 2.5 mm ² (AWG 13)

Approvals / marking



G 27611



0786-CPR-20208



Heat detector WMX1000D90

Technical specifications

Response category	C,
Static threshold value	+84 °C to +100 °C (+183.2 °F to +212 °F)
Operating temperature	-20 °C to +80 °C (-4 °F to +176 °F)
Weight	140 g (0.3 lbs)

Part no.: 747878

Approvals / marking



G 29109



0786-CPR-20209



Otherwise like part no. 747866



Standard detectors

Detector accessories, conventional

Detector base metric, 3-pin



Part no.: 903502

Standard detector base

Not included in delivery

Membrane plug M16x1.5 (side cable entry)	902313
Membrane plug M20 PE (rear cable entry)	902541
End cap white (side cable entry)	795007
End of line-resistor 1.8 K /0.5 W	675235
Mounting materials	

Spare parts

Contact blade	761756
Terminal	212400
Cylinder head screw M4x6 DIN84	237829
Serrated lock washer A4,3 DIN6798	606073

Technical specifications

Enclosure material	Polycarbonate
Relative humidity	max. 100 %
Color	white
Operating temperature	-40 °C to +100 °C (-40 °F to +212 °F)
Weight	100 g (0.2 lbs)
Dimensions	113 mm (D) 4.5 inch (D)

Detector base metric, 5-pin



Part no.: 903503

Detector base with connection remote indicator.

Not included in delivery

Membrane plug M16x1.5 (side cable entry)	902313
Membrane plug M20 PE (rear cable entry)	902541
End cap white (side cable entry)	795007
End of line-resistor 1.8 K /0.5 W	675235
Mounting materials	

Spare parts

Contact blade	761756
Terminal	212400
Cylinder head screw M4x6 DIN84	237829
Serrated lock washer A4.3 DIN6798	606073

Technical specifications

Enclosure material	Polycarbonate
Relative humidity	max. 100 %
Color	white
Operating temperature	-40 °C to +100 °C (-40 °F to +212 °F)
Weight	100 g (0.2 lbs)
Dimensions	113 mm (D) 4.5 inch (D)



Standard detectors

Optical smoke detectors, conventional

Optical smoke detector OMX ECO1003



Product features

- Constant function monitoring of the sensors, software and hardware including the microcontroller
- Evaluation of the signals with algorithms, which make the detector less sensitive to sources of deception
- Automatic drift compensation
- Remote test unit for simplified commissioning

Technical specifications

Detection method	Infrared photo diode
Technology	conventional
Operating voltage	8 V - 30 V DC
Recommended line voltage	12 V DC
Quiescent current	6.7 mA at 12 V
Alarm current ¹⁾	14.7 mA at 12 V
Alarm indication ¹⁾	1 LED red, steady light
Operating temperature	-30 °C to +70 °C (-22 °F to 158 °F)
IP rating (EN 60529)	IP 40
Enclosure material	ABS white
Relative humidity	0 to 95% no condensation
Weight	75 g (0.2 lbs)
Dimensions	102 x 42 mm (DxH) 4.0 x 2.0 inch (DxH)

Part no.: 921684

Conventional optical smoke detector for application in areas where formation of smoke is to be anticipated in case of fire. Smoke detector with special design that uses algorithms for evaluation, thus achieving high reliability in early fire detection.

Not included in delivery

Detector base BAX ECO 470 Ohm	921689
End of line-resistor 1.8 K / 0.5 W	675235

Connecting / mounting

Connection cable standard detector	2-wire
Remote indication	2-wire
Recommended cable	JY (St) Y 2x2x0.8 mm
Conductor cross-section	max. 2 mm ² (AWG 14)

Approvals / marking



G 201060



0832-CPD-0064

Wiring diagram of a conventional line with detectors of the series ECO1000

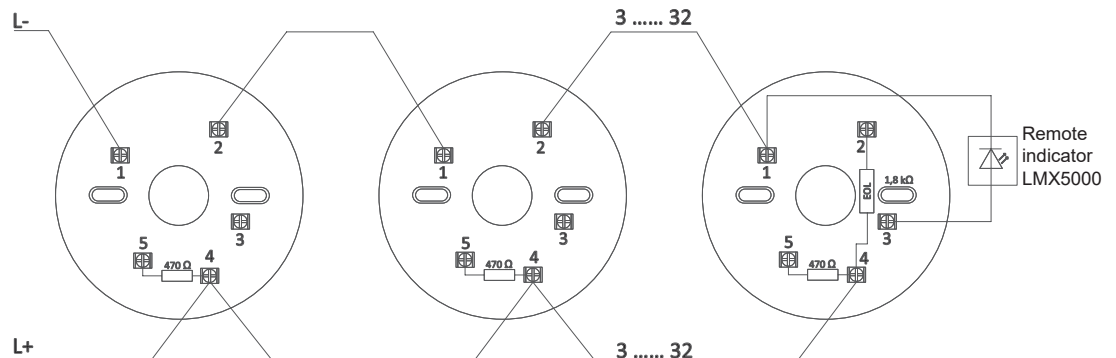

¹⁾ In combination with Detector base BAX ECO 470 Ohm and End of line-resistor 1.8 K / 0.5 W. Current consumption dependent on terminal resistor and line voltage.



Standard detectors

Multisensor detectors, conventional

Multisensor detector OWMX ECO1002



Product features

- Constant function monitoring of the sensors, software and hardware including the microcontroller
- Evaluation of the signals with algorithms, which make the detector less sensitive to sources of deception
- Automatic drift compensation
- Remote test unit for simplified commissioning

Technical specifications

Detection method smoke	Infrared photo diode
Detection method heat	NTC temperature sensor
Technology	conventional
Operating voltage	8 V - 30 V DC
Recommended line voltage	12 V DC
Quiescent current	6.7 mA at 12 V
Alarm current ¹⁾	14.7 mA at 12 V
Alarm indication	1 LED red
Operating temperature	-30 °C to +70 °C (-22 °F to 158 °F)
IP rating (EN 60529)	IP 20
Enclosure material	ABS white
Relative humidity	5 to 95% no condensation
Weight	78 g (0.2 lbs)
Dimensions	102 x 50 mm (DxH) 4.0 x 2.0 inch (DxH)

Wiring diagram

of a conventional line with detectors of the series ECO1000

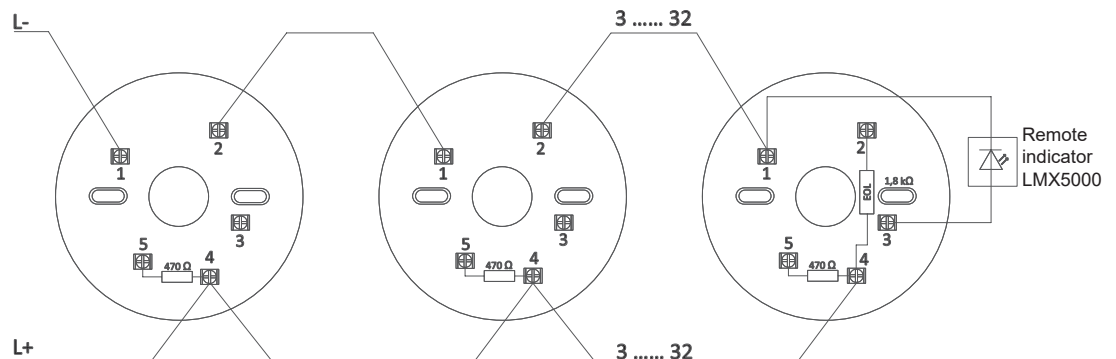

Part no.: 921685

Multisensor detector consisting of a combination of an optical smoke detector and a heat detector. Designed for the application in areas where periodically occurring sources of deception are to be anticipated. The multisensor detector is a thermally supported smoke detector. Its sensitivity is considerably increased in case of flaming fires.

Not included in delivery

Detector base BAX ECO 470 Ohm	921689
End of line-resistor 1.8 K / 0.5 W	675235

Connecting / mounting

Connection cable standard detector	2-wire
Remote indication	2-wire
Recommended cable	JY (St) Y 2x2x0.8 mm
Conductor cross-section	max. 2 mm ² (AWG 14)

Approvals / marking



G 201067



0832-CPD-0065

¹⁾ In combination with Detector base BAX ECO 470 Ohm and End of line-resistor 1.8 K / 0.5 W. Current consumption dependent on terminal resistor and line voltage.



Standard detectors

Optical smoke detectors, conventional

Optical smoke detector OMX2151



Product features

- Modern and low-profile design
- 2 LEDs provide 360° visibility in both standby and alarm modes
- Adaptation to the environmental conditions through automatic drift compensation
- Stable performance in high air velocities

Technical specifications

Detection method	Infrared photo diode
Technology	conventional
Operating voltage	8.5 V - 35 V DC
Quiescent current	0.12 mA
Alarm current	10 - 62 mA
Alarm indication	2 LEDs red, steady light
Operating temperature	0 °C to +49 °C (+32 °F to +120.2 °F)
Enclosure material	PC/ ABS Blend
Relative humidity	10 to 93% no condensation
Weight	88 g (0.2 lbs)
Dimensions (installed in detector base)	157 x 42 mm (DxH) 6.2 x 1.7 inch (DxH)

Part no.: 918417

Conventional optical smoke detector for application in areas where formation of smoke is to be anticipated in case of fire.

Not included in delivery

Detector base BAX B110RLP 918421

Connecting / mounting

Connection cable standard detector 2-wire
(Connection via detector base)

Note

Distribution only to non-EU countries.

Approvals / marking





Standard detectors

Multisensor detectors, conventional

Multisensor detector OWMX2151T

Part no.: 918419

Conventional multisensor detector consisting of a combination of optical smoke detector and heat detector.



Product features

- 2 LEDs provide 360° visibility in both standby and alarm modes
- Adaptation to the environmental conditions through automatic drift compensation
- Stable performance in high air velocities

Not included in delivery

Detector base BAX B110RLP 918421

Connecting / mounting

Connection cable standard detector 2-wire
(Connection by detector base)

Note

Distribution only to non-EU countries.

Technical specifications

Smoke detection method	Infrared photo diode
Heat detection method	NTC temperature sensor
Technology	conventional
Operating voltage	8.5 V - 35 V DC
Quiescent current	0.12 mA
Alarm current	10 - 62 mA
Alarm indication	2 LEDs red, steady light
Operating temperature (according to UL Standard)	0 °C to +38 °C (+32 °F to +100.4 °F)
Enclosure material	PC/ABS Blend
Relative humidity	max. 93% no condensation
Weight	88 g (0.2 lbs)
Dimensions (installed in detector base)	157 x 42 mm (DxH) 6.2 x 1.7 inch (DxH)

Approvals / marking





Standard detectors

Heat detectors, conventional

Heat detector WMX5151



Product features

- Modern and low-profile design
- 2 LEDs provide 360° visibility in both standby and alarm modes
- Easily accessible test marker for the application of a functional magnet in order to alarm for service purposes

Technical specifications

Detection method	NTC temperature sensor
Technology	conventional
Operating voltage	8.5 V - 35 V DC
Quiescent current	0.08 mA
Alarm current	10 - 62 mA
Alarm indication	2 LEDs red, steady light
Static threshold value	+57.2 °C +135 °F
Operating temperature (according to UL Standard)	0°C to +38 °C (+32 °F to +100.4 °F)
Enclosure material	PC/ABS Blend
Relative humidity	10 to 93% no condensation
Weight	80 g (0.2 lbs)
Dimensions (installed in detector base)	157 x 42 mm (DxH) 6.2 x 1.7 inch (DxH)

Part no.: 918418

Conventional heat differential maximum detector. Designed for application in areas where rapid development of heat through flames is to be anticipated.

Not included in delivery

Detector base BAX B110RLP 918421

Connecting / mounting

Connection cable standard detector 2-wire
(Connection via detector base)

Note

Distribution only to non-EU countries.

Approvals / marking





Standard detectors

Heat detectors, conventional

Heat detector WMX ECO1004T Class BS

Part no.: 921687



Conventional static heat detector. Designed for application in areas where high rates of temperature rise may be sustained for long periods, such as boiler rooms and kitchens.

Product features

- Static measurement of increase in temperature
- Constant function monitoring of the sensors, software and hardware including the microcontroller
- Evaluation of the signals with algorithms, which make the detector less sensitive to sources of deception
- Remote test unit for simplified commissioning

Not included in delivery

Detector base BAX ECO 470 Ohm 921689
End of line-resistor 1.8 K / 0.5 W 675235

Technical specifications

Detection method	NTC temperature sensor
Technology	conventional
Operating voltage	8 V - 30 V DC
Recommended line voltage	mod S 12 V DC
Quiescent current ¹⁾	6.7 mA at 12 V
Alarm current ¹⁾	14.7 mA at 12 V
Alarm indication	1 LED red
Temperature class, rate of rise measurement	Class B, acc. EN 54-5: 2000 / A1:2002
Static response temperature	69 °C to 85 °C (156.2 °F to 185 °F)
Operating temperature	-30 °C to +70 °C (-22 °F to +158 °F)
IP rating (EN 60529)	IP 20
Enclosure material	ABS white
Relative humidity (IEC 721-3-3)	max. 98% no condensation
Weight	70 g (0.2 lb)
Dimensions	102 x 50 mm (DxH) 4.0 x 2.0 inch (DxH)

Connection / mounting

Connection cable standard detector 2-wire
Remote indication 2-wire
Recommended cable JBY (St) Y 2x2x0.8 mm
Conductor cross-section max. 2 mm² (AWG 14)

Approvals / marking



G 204042



0832-CPD-0068

Wiring diagram of a conventional line with detectors of the series ECO1000

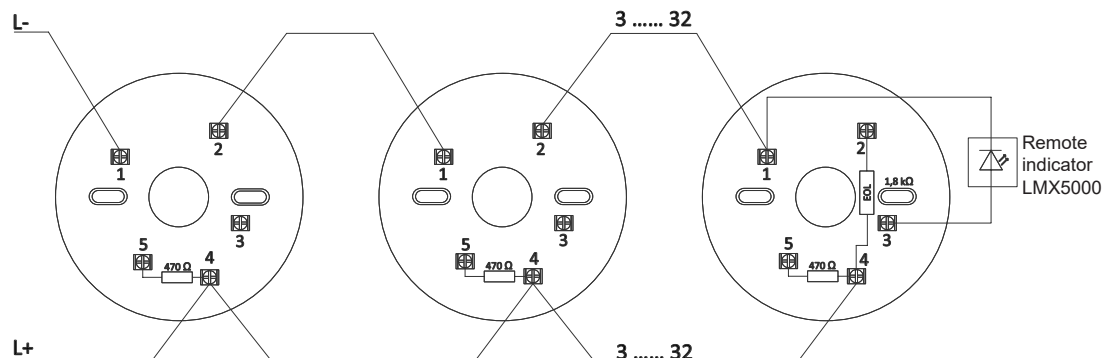

¹⁾ In combination with Detector base BAX ECO 470 Ohm and End of line-resistor 1.8 K / 0.5 W. Current consumption dependent on terminal resistance and line voltage.



Standard detectors

Heat detectors, conventional

Heat detector WMX ECO1005T Class A2S



Product features

- Static measurement of increase in temperature
- Constant function monitoring of the sensors, software and hardware including the microcontroller
- Evaluation of the signals with algorithms, which make the detector less sensitive to sources of deception
- Remote test unit for simplified commissioning

Technical specifications

Detection method	NTC temperature sensor
Technology	conventional
Operating voltage	8 V - 30 V DC
Recommended line voltage	12 V DC
Quiescent current	6.7 mA at 12 V
Alarm current ¹⁾	14.7 mA at 12 V
Alarm indication	1 LED red
Temperature class, rate of rise measurement	Class A2, acc. EN 54-5: 2000 / A1:2002
Static response temperature	54 °C to 70 °C (129.2 °F to 158 °F)
Operating temperature	-30 °C to +70 °C (-22 °F to +158 °F)
IP rating (EN 60529)	IP 20
Enclosure material	ABS white
Relative humidity	max. 98% no condensation
Weight	70 g (0.2 lbs)
Dimensions	102 x 50 mm (D x H) 4.0 x 2.0 inch (D x H)

Part no.: 921686

Conventional static heat detector. Designed for application in areas where high rates of temperature rise may be sustained for long periods, such as boiler rooms or kitchens.

Not included in delivery

Detector base BAX ECO 470 Ohm	921689
End of line-resistor 1.8 K / 0.5 W	675235

Connection / mounting

Connection cable standard detector	2-wire
Remote indication	2-wire
Recommended cable	JBY (St) Y 2x2x0.8 mm
Conductor cross-section	max. 2 mm ² (AWG 14)

Approvals / marking



G 201073



0832-CPD-0067

Wiring diagram of a conventional line with detectors of the series ECO1000

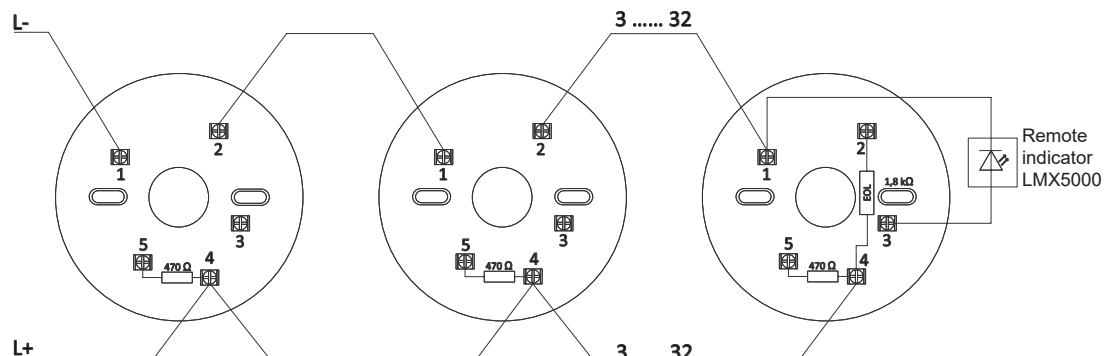

¹⁾ In combination with Detector base BAX ECO 470 Ohm and End of line-resistor 1.8 K / 0.5 W. Current consumption dependent on terminal resistor and line voltage.



Standard detectors

Heat detectors, conventional

Heat detector WMX ECO1005 Class A1R



Part no.: 921688

Conventional combined rate-of-rise and static heat detector. Designed for areas with rapid rise of temperature caused by flames.

Product features

- Combined rate-of-rise and static measurement
- Constant function monitoring of the sensors, software and hardware including the microcontroller
- Evaluation of the signals with algorithms, which make the detector less sensitive to sources of deception
- Remote test unit for simplified commissioning

Technical specifications

Detection method	NTC temperature sensor
Technology	conventional
Operating voltage	8 V - 30 V DC
Recommended line voltage	12 V DC
Quiescent current	6.7 mA at 12 V
Alarm current ¹⁾	14.7 mA at 12 V
Alarm indication	1 LED red
Temperature class, rate of rise measurement	Class A1, acc. EN 54-5: 2000 / A1:2002
Static response temperature	54 °C to 65 °C (129.2 °F to 149 °F)
Operating temperature	-30 °C to +70 °C (-22 °F to +158 °F)
IP rating (EN 60529)	IP 20
Enclosure material	ABS white
Relative humidity	max. 98% no condensation
Weight	70 g (0.2 lb)
Dimensions	102 x 50 mm (DxH) 4.0 x 2.0 inch (DxH)

Not included in delivery

Detector base BAX ECO 470 Ohm	921689
End of line-resistor 1.8 K / 0.5 W	675235

Connection / mounting

Connection cable standard detector	2-wire
Remote indication	2-wire
Recommended cable	JBY (St) Y 2x2x0.8 mm
Conductor cross-section	max. 2 mm ² (AWG 14)

Approvals / marking



G 201016



0832-CPD-0066

Wiring diagram of a conventional line with detectors of the series ECO1000

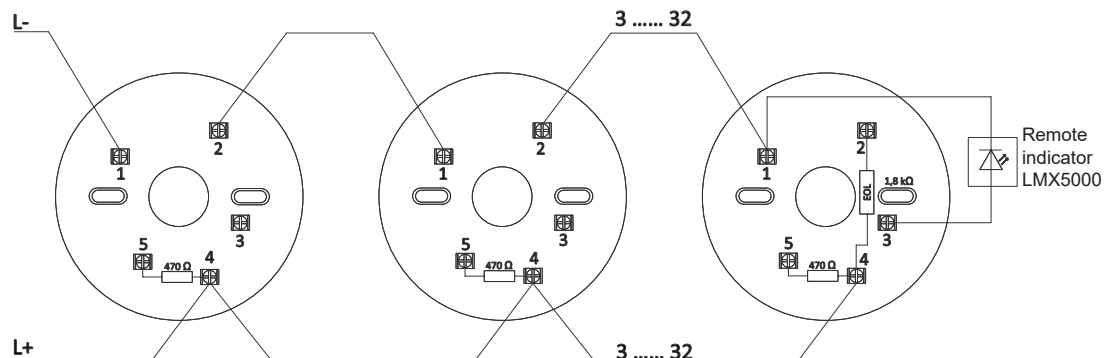

¹⁾ In combination with Detector base BAX ECO 470 Ohm and End of line-resistor 1.8 K / 0.5 W



Standard detectors

Detector accessories, conventional

Detector base BAX B110RLP



Part no.: 918421

Detector base can be used for OMX2151 WMX5151 and OWMX2151T. A resistor of 470 Ohm is integrated.

Not included in delivery

Mounting hardware
Back box
End of line-resistor (EOL)

Note

Distribution only to non-EU countries.

Technical specifications

Material	PC/ABS Blend
Relative humidity	10 to 93%
Colour	white
Operating temperature	0 °C to +49 °C (+32 °F to +120.2 °F)
Weight	130 g (0.3 lbs)
Dimensions	157 mm (D) 6.2 inch (D)

Parallel indicator RA100Z



Part no.: 918422

Additional alarm indication for detectors with non-visible alarm LED e.g. in false floors.

Not included in delivery

Mounting hardware
Back box/Single-Gang J-Box

Note

For use with conventional system the provided jumper must be installed according to the instructions.

Technical specifications

Operating voltage	3,1 - 32 V DC
Alarm indication	1 LED, red
Alarm current	10 mA
Enclosure material	PC/ABS Blend
Ambient temperature	-10 °C to +60 °C (+14 °F to +140 °F)
Weight	62 g (0.1 lbs)
Dimensions	71 x 117 x 33 mm (BxHxT) 2.8 x 4.6 x 1.3 inch (WxHxD)

Approvals / marking





Standard detectors

Detector accessories, conventional

Detector base BAX ECO 470 Ohm

Part no.: 921689

Standard detector base with integrated alarm resistor

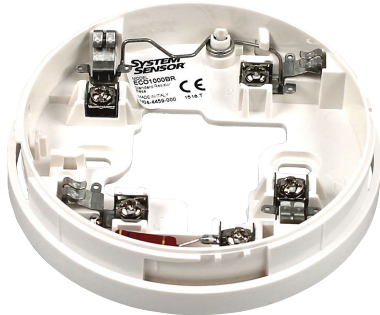

Not included in delivery

Mounting hardware

Technical specifications

Enclosure material	ABS
Relative humidity	max. 95 % no condensation
Color	white
Operating temperature	-30 °C to +70 °C (-22 °F to 158 °F)
Weight	42 g (0.09 lb)
Dimensions	102 mm (D) 4.0 inch (D)

Approvals / marking



Remote test unit ECO1000 RTU

Part no.: 921690

For the ECO1000 product range an alarm can be triggered for test and commissioning purposes without the need of step ladders or long poles. For this, the modulated laser beam of the remote test unit is directed at the detectors LED, whereby the detector latches into alarm.



Product feature

- Simple and fast triggering of test alarms for ECO1000 series detectors

Technical specifications

Alarm trigger	latching, no functional sensor test
Battery	included in delivery
Batteries required	1 x 6 V, type 11A
Weight	23 g (0.05 lb)

Approvals / marking





Standard detectors

Optical smoke detectors, conventional, Ex

Optical smoke detector OMX 1001C Ex



Product features

- Constant function monitoring of sensors, software and hardware including the microcontroller
- Normal operation indication by green flashing light
- Automatic drift compensation
- Robust smoke detector
- Use in Ex zone 1 and 2

Technical specifications

Detection method	Infrared photo diode
Measurement chamber sensitivity	approx. 0.16 dB/m (39.4 inch)
Number of detectors per line	max. 24
Technology	conventional
Operating voltage	7.6 V - 13.2 V DC
Quiescent current	approx. 0.35 mA
Alarm current	approx. 18 mA
Alarm indication	1 LED red, permanent light
Normal operation indication	1 LED green, flashing light
Electrostatic shielding	recommended
Operating temperature, T4	-20 °C to +60 °C (-4 °F to +140 °F)
Operating temperature, T6	-20 °C to +40 °C (-4 °F to +104 °F)
Storage temperature	-40 °C to +85 °C (-40 °F to +185 °F)
IP rating (EN 60529)	IP 43, with membrane plug and sealing of the mounting holes
Enclosure material	white polycarbonate
Relative humidity	max. 95% at 35 °C (+95 °F) no condensation
Specification according to	EN 54-7
Weight	240 g (0.5 lbs)
Dimensions	113 x 68 mm (DxH) 4.5 x 2.7 inch (DxH)

Part no.: 800833

Conventional intrinsically safe optical smoke detector for Ex zone 1. Designed for use in areas with smoke in case of fire. Robust smoke detector with drift compensation for use in industrial environments. Designed for use in hazardous areas connected to a safety barrier Ex Standard 9 V. The barrier has to be placed in non hazardous areas.

Not included in delivery

Detector base	903502 or 903503
	see detectors accessories, conventional
End of line-resistor 1.8 K / 0.5 W	675235
Dust cover	894760
Safety barrier SBEx-9	933093

Connection / mounting

Connection cable standard detector	2-wire
Remote Indication	2-wire
Recommended cable	JEY (St) Y 2x2x0.8 mm, blue
Conductor cross-section	max. 2.5 mm ² (AWG 13)

Note

The detector housing has a high surface resistance. Avoid electrostatic charging.

Approvals / marking

EC type approval certificate: DMT 00 ATEX E 043



G 200005



0786-CPR-20131





Standard detectors

Ionisation smoke detectors, conventional, Ex

Ionization smoke detector IMX 1001E Ex



Part no.: 782410

Conventional ionization smoke detector for Ex zone 1. Designed for use in areas with smoke in case of fire. Robust smoke detector with a dual ionization chamber for use in industrial environments. Designed for use in hazardous areas connected to a safety barrier Ex Standard 9 V. The barrier has to be placed in non hazard areas.

Product features

- Drift compensation by dual ionization
- Robust smoke detector
- Use in Ex zone 1 and 2

Technical specifications

Detection method	Double ionization chambers
Technology	conventional
Operating voltage	7.6 V - 13.2 V DC
Quiescent current	approx. 0.08 mA
Alarm current	approx. 20 mA
Alarm indication	1 LED red
Sensitivity	$\gamma = 0.8$
Air flow	max. 5 m/s
Radioactivity Am241	2.8 kBq
Electrostatic shielding	recommended
Operating temperature T4	-20 °C to +75 °C (-4 °F to +167 °F)
Operating temperature T6	-20 °C to +40 °C (-4 °F to +104 °F)
Storage temperature	-30 °C to +80 °C (-22 °F to +176 °F)
IP rating (EN 60529)	IP 43, with membrane plug and sealing of the mounting holes
Enclosure material	white polycarbonate
Relative humidity	max. 98% at 35°C (+95 °F) Avoid condensation
Specification according to	EN 54-7
Weight	230 g (0.5 lbs)
Dimensions	113 x 68 mm (DxH) 4.5 x 2.7 inch (DxH)

Not included in delivery

Detector base	903502 or 903503
	see detectors accessories, conventional
End of line-resistor 1.8 K / 0.5 W	675235
Dust cover	894760
Safety barrier SBEx-9	933093

Connection / mounting

Connection cable standard detector	2-wire
Remote Indication	2-wire
Recommended cable	JEY (St) Y 2x2x0.8 mm, blue
Conductor cross-section	max. 2.5 mm ² (AWG 13)

Note

The detector housing has a high surface resistance. Avoid electrostatic charging. The detector contains radioactive materials. The operating instructions and current laws and regulations on radiation protection must be observed.

Approvals / marking

EC type approval certificate: BVS 03 ATEX 2110



G 28119



0786-CPR-20211





Standard detectors

Heat detectors, conventional, Ex

Heat detector WMX 1000D60 Ex



Product features

- Adaptation to ambient temperature by 2 temperature sensors
- Combined rate-of-rise and static measurement
- Robust heat detector
- Use in Ex zone 1 and 2

Technical specifications

Detection method	NTC-temperature sensor
Response category	A1
Technology	conventional
Operating voltage	7.6 V - 13.2 V DC
Quiescent current	approx. 0.07 mA
Alarm current	approx. 15 mA
Alarm indication	1 LED red
Static threshold value	+54 °C to +62 °C (+129.2 °F to +143.6 °F)
Electrostatic shielding	recommended
Operating temperature	-20 °C to +50 °C (-4 °F to +122 °F)
IP rating (EN 60529)	IP 23, with membrane plug and sealing of the mounting holes
Enclosure material	Polycarbonate, white
Relative humidity	max. 95% no condensation
Specification according to	EN 54-5
Weight	140 g (0.3 lbs)
Dimensions	113 x 68 mm (DxH) 4.5 x 2.7 inch (DxH)

Part no.: 782422

Conventional combined rate of rise and static heat detector for Ex zone 1. Designed for areas with rapid raise of temperature by flames. Heat detector with 2 temperature sensors for use in industrial environments. Designed for use in hazardous areas connected to a safety barrier Ex Standard 9 V. The barrier has to be placed in non hazardous areas.

Not included in delivery

Detector base	903502 or 903503
	see detectors accessories, conventional
End of line-resistor 1.8 K / 0.5 W	675235
Dust cover	894760
Safety barrier SBEx-9	933093

Connection / mounting

Connection cable standard detector	2-wire
Remote Indication	2-wire
Recommended cable	JEY (St) Y 2x2x0.8 mm, blue
Conductor cross-section	max. 2.5 mm ² (AWG 13)

Note

The detector housing has a high surface resistance. Avoid electrostatic charging.

Approvals / marking

EC type approval certificate: BVS 03 ATEX E 104



G 27918



0786-CPR-20208





Standard detectors

Heat detectors, conventional, Ex



Heat detector WMX1000D90 Ex

Part no.: 782434

Technical specifications

Response category	C,
Static threshold value	+84 °C to +100 °C (+183.2 °F to +212 °F)
Operating temperature	-20 °C to +80 °C (-4 °F to +176 °F)
Weight	140 g (0.3 lbs)

Approvals / marking

EC type approval certificate: BVS 03 ATEX E 104



G 27918



0786-CPD-20209



Otherwise like part no.: 782422

Heat detector WMX1000D105 Ex

Part no.: 907368

Technical specifications

Response category	D
Static threshold value	+100 °C to +115 °C (+212 °F to +239 °F)
Operating temperature	-20 °C to +80 °C (-4 °F to +176 °F)
Weight	140 g (0.3 lbs)



Otherwise like part no.: 782422

Heat detector WMX1000D80M Ex

Part no.: 903508

Technical specifications

Static threshold value	+77 °C to +83 °C (+170.6 °F to +181.4 °F)
Operating temperature	-20 °C to +70 °C (-4 °F to +158 °F)
Weight	130 g (0.3 lbs)



Otherwise like part no.: 782422



Standard detectors

Detector accessories, conventional, Ex

Junction box Ex



Part no.: 900288

Junction box for hazard areas, can be used in zone 1.

Included in delivery

1 Junction box Ex with 4 cable glands M25 for cable
Ø 10 - 17 mm and 2 closures M25.
6 Clamps, clamping range to 2.5 mm² (AWG13)

Not included in delivery

Mounting hardware

Technical specifications

Material	Polyamide
IP rating (EN 60529)	IP 66
Colour	black
Operating temperature	-20 °C to +40 °C (-4 °F to +104 °F)
Weight	300 g (0.66 lbs)
Dimensions	122 x 180 x 61 mm (WxHxD) 4.8 x 7.1 x 2.4 inch (WxHxD)

Approvals / marking

Ex conformity in acc. with 94/9/EG

x II 2G Ex dem ia II, IIC T6
PTB 00 ATEX 3108

EC type approval certificate:





Standard detectors

Detector accessories

Additional mounting base ABS



Part no.: 905403

For surface mounting of detector bases, with lateral cable entry for M20 cable glands. Use for all white Minimax and Apollo detectors. Stable ABS enclosure in robust design.

Not included in delivery

Cable glands M20x1.5
Blind plug

902901
902922

Technical specifications

Material	ABS, white
Weight	404 g (0.9 lbs)
Dimensions	146 x 38 mm (dia. x H) 5.8 x 1.5 inch (dia. x H)

Cable floor-detector holder BHX 1000, d=20 to 25 mm (0.79 to 0.98 inch)

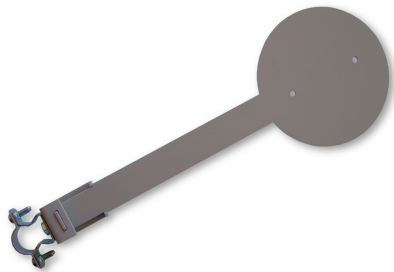

Part no.: 908691

Cable floor-detector holder for underfloor installation. The standard fastener is designed for round pipes with a diameter of 20 - 25 mm (0.78 - 0.98 inch). Other fasteners on request. The plate area is designed for smoke and heat detector bases detector suppliers Minimax, detectomat, Apollo, Esser by Honeywell, Notifier.

Included in delivery

1 Packaging unit (10 x)
Cable floor-detector holder BHX 1000
2 Mounting screws 4.2 x 13 (DIN 7981-St)

Technical specifications

Material	Sheet steel, powder-coated
Color	RAL 7035
Operating temperature	-20 °C to +70 °C (-4 °F to +158 °F)
Weight	290 g (0.6 lbs)
Dimensions	112 x 330 mm (dia. x H) 4.4 x 13 inch (dia. x H)



Standard detectors

Detector accessories

Detector assembly console MMK-90



Part no.: 4001945

Detector assembly console for easy ceiling mounting and variable adjustment of smoke, heat and multisensor detectors in slanting ceilings.

Included in delivery

Mounting material

Technical specifications

Material	Sheet steel, powder-coated
Inclination angle	max. 90 °
Color	pure white RAL 9010
Weight	500 g (1.1 lbs)
Dimensions	150 x 114 x 39 mm (WxHxD) 5.91 x 4.49 x 1.54 inch (WxHxD)

Detector assembly console MMK-200/350



Part no.: 4001286

Foldable detector assembly console for floor and ceiling mounting and variable adjustment of smoke, heat and multisensor detectors. Adjustable length 200 to 350 mm.

Included in delivery

Mounting material

Technical specifications

Material	Sheet steel, powder-coated
Inclination angle	max. 90 °
Color	pure white RAL 9010
Weight	800 g (1.76 lbs)
Dimensions	175 x 200 x 126 mm (WxHxD) 6.89 x 7.87 x 4.96 inch (WxHxD)



Standard detectors

Detector accessories

Remote indicator LMX5000



Part no.: 908499

Additional remote indication for detectors with non visible alarm LED e.g. in false floors. Insertable for Loop AP, MxLoop® and conventional technology.

Not included in delivery

Mounting materials

Note

Use is not permitted in potentially explosive atmospheres.

Approvals / marking



Technical specifications

Nominal voltage Loop AP / conventional	24 V DC 9 V DC
Electrostatic shielding	not required
Enclosure material	ABS, RAL 9010 - white
Relative humidity	98 %, avoid condensation
Ambient temperature	-10 °C to +60 °C (-14 °F to +140 °F)
IP rating	IP 30
Weight	66 g (0.2 lbs)
Dimensions	84 x 84 x 35 mm (WxHxD) 3.3 x 3.3 x 1.4 inch (WxHxD)



Standard detectors

Detector accessories

Junction box ACX 204



Part no.: 901247

Junction box for flush mounted installation by the customer in concrete ceiling slabs, with prefabricated attachment points for the detector base. Break-off tabs for cable entries, M16 and M20 wiring conduit.

Note

Not applicable in combination with:

- detector base metric, 3-pin 903502
- detector base metric, 5-pin 903503
- and the associated detectors series

Approvals / marking



Technical specifications

Material	PC
Dimensions	100 x 8 mm (dia. x H) 3.9 x 0.3 inch (dia. x H)

Backplate ACX 233



Part no.: 901245

Protection plate against dust and water to add to the detector base during assembly. When using addressable detectors the number identification must be removed and inserted at the points provided in the backplate.

Note

Not applicable in combination with:

- detector base metric, 3-pin 903502
- detector base metric, 5-pin 903503
- and the associated detectors series

Approvals / marking





Standard detectors

Modules, addressable, DIN rail mounting

Input module IUX 760 M-I



Part no.: 908531

Miniature interface for use in devices with little space. The mini switch monitor monitors the state of one or more dry normally open contacts and reports the status to a fire alarm panel. Applicable for operation in fire alarm panels with Loop AP protocol. Optional equipped with interrupt for rapid alarm signals like a manual call point. The states "quiescent", "pre-alarm", "alarm" and "fault" can be recognized. Addressing via DIP switches; the address can also be modified after installation.

Technical specifications

Operating voltage	17 V - 28 V DC
Current consumption at 24 V DC:	
Min. (quiescent)	0.2 mA
Max. (alarm input)	3.6 mA
Inputs	1
Outputs	0
Alarm indication	red LED
Bus activity indication	green LED
Short-circuit indication on the loop or fault of the monitors input	yellow LED
Integrated isolator	yes
Operating temperature	-20 °C to +60 °C (-4 °F to +140 °F)
Technology / protocol	Loop AP / XP95
Relative humidity	0 to 95% no condensation
Weight	30 g (0.1 lbs)
Dimensions	39 x 39 x 20 mm (WxHxD) 1.5 x 1.5 x 0.8 inch (WxHxD)

Connection / mounting

Connection cable	2-wire
Recommended cable, standard	747180
JY(ST)Y-2x2x0.8 mm	
Conductor cross-section	max. 1,5 mm ² (AWG 15)
Electrostatic shielding	not required

Contact input:	
Voltage at contact input	9 - 11 V DC
Cable resistance max.	50 Ohm
End-of-line resistor EOL (R3)	20 kOhm
Pre-alarm resistor (R2)	10 kOhm
Alarm resistor (R1)	1 kOhm

Connection diagram

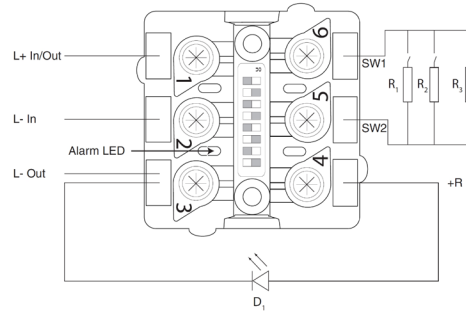

Approvals / marking



G 210034



2531-CPR-CSP11042



Standard detectors

Modules, addressable, DIN rail mounting

Sounder control module SCX 182 R



Inputs : 1 (contact input)
Outputs : 1

Technical specifications

Operating voltage	17 V - 28 V DC
Current consumption:	
Quiescent	1.9 mA
Output active	1.7 mA
Short circuit	4.5 mA
Indication of activated output	red LED
Fault indication	yellow LED
Integrated isolator	no
Operating temperature	-20 °C to +70 °C (-4 °F to +158 °F)
IP rating (EN 60529)	IP 20
Technology / protocol	Loop AP / XP95
Relative humidity	max. 95% no condensation
Specification according to	CEA GEI 1-052 (6/97)
Weight	95 g (0.2 lbs)
Dimensions	110 x 107 x 20 mm (WxHxD) 4.3 x 4.2 x 0.8 inch (WxHxD)

Approvals / marking



2531-CPR-CSP11127

Part no.: 905396

Analogue addressable sounder control module for controlling sounders in continuous or pulse-controlled operation with additional contact input for monitoring the external power supply of the sounders. DIN rail (R) installation versions. Applicable for operation in fire alarm panels with Loop AP protocol. Addressing via DIP switches; the address can also be modified after installation.

Connection / mounting

Connection cable 2-wire
 Recommended cable, standard 747180
 J-Y(ST)Y-2x2x0.8 mm
 Conductor cross-section max. 1.5 mm² (AWG 15)
 Electrostatic shielding not required

External power supply 9 - 50 V DC
 Contact input NC for failure of the external power supply

Relay output:
 Voltage max. 35 V DC
 Current max. 4 A DC

Note

The output of the sounder control module operates with polarity switching. The device is connected with reversed voltage polarity. Triggering the device output activates the polarity switchover which activates the connected sounders.

Connection diagram

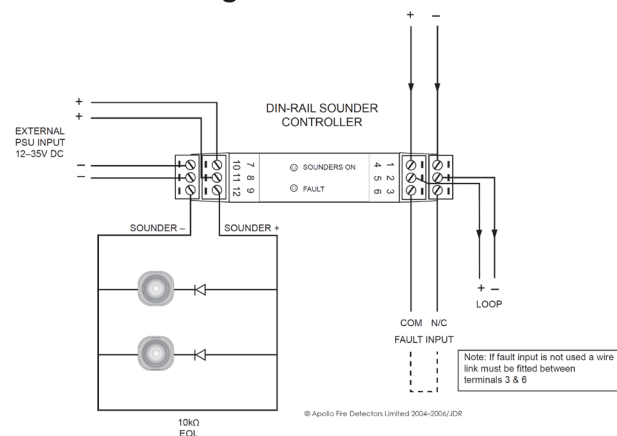



Standard detectors

Modules, addressable, DIN rail mounting

FMZ 5000 loop coupler module



Product features

- For the interface connection of conventional detectors to a loop of the loop module
- The module has four conventional detector zones
- Alarm and pre-alarm of every zone are transmitted. The zones can be deactivated individually via the loop
- For installation into the fire alarm panel

Technical specifications

Operating voltage	19 V - 29 V DC
Quiescent current	approx. 20 mA without line terminations
Current consumption per line	max. 100 mA DC
Line voltage, min	9 V - 19 V DC
Technology / protocol	Loop AP / XP95
Alarm / terminating resistor	470 Ohm / 1.8 kOhm
Number of lines per module	4
Number of detectors per line	32
Max. terminal cross-section	2.5 mm ² (AWG 13)
Integrated isolator	no
Ambient temperature	-5 °C to +40 °C (+23 °F to +104 °F)
Relative humidity (IEC 721-3-3)	max. 95 % no condensation
IP rating (EN 60529)	IP 20
Enclosure	Polyamide PA6.6, green
Detectors per loop	max. 30
Mounting	Mounting rail 35 DIN 46277, top hat profile
Weight	200 g (0.4 lbs)
Dimensions	35 x 99 x 114.5 mm (WxHxD) 1.4 x 3.9 x 4.5 inch (WxHxD)

Approvals / marking



see panels



Part no.: 902954

Functional module for use in all design variants of the fire alarm system FMZ 5000. The loop coupler module is a loop node on a loop of the loop module. It includes 4 conventional detector zones with their own addresses, which are detected and dealt by the fire alarm panel like four detectors of the detector loop. The status of the detector zones and the detectors are reported to the fire alarm panel via the configured address. Detectors can be connected in two-detector dependencies and groups can be connected in group dependencies. For use in hazard areas, detectors in intrinsically safe design can be connected via suitable barriers. The detector lines have a common base address, which is set in increments of 4 for all detector lines. The module has a default configuration that can be modified using the configuration software Mx-LoopCon, Part no. 904001.

Application

Mainly for the interface connection of industrial detectors in conventional detector technology to a Loop AP.

Included in delivery

Module completely assembled and ready for installation in the fire alarm panel.

Optional accessories

Configuration software MXLoopCon 904001

Note

The module must not be plugged in together with other functional modules of the FMZ 5000 series. It has to be individually placed in the fire alarm panel. To supply the conventional lines, the loop coupler module requires an external 24 V DC power supply.

Connection diagram

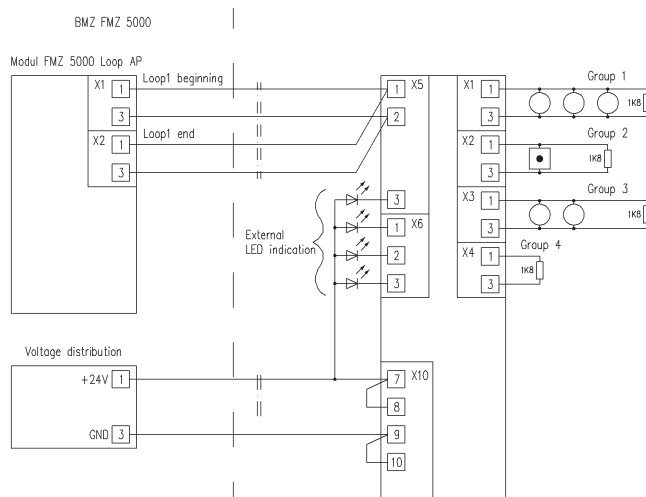



Standard detectors

Modules, addressable, wall mounting

Input/output module IOX 588 W-I



Technical specifications

Operating voltage	17 V - 28 V DC
Current consumption:	
Quiescent	3.0 mA
Maximal	7.5 mA
Inputs	3
Outputs	3
Indication input active	3 red LEDs
Active output indication	3 red LEDs
Fault indication input	3 yellow LEDs
Fault indication isolator	yellow LED
Integrated isolator	yes
Operating temperature	-20 °C to +70 °C (-4 °F to +158 °F)
IP rating (EN 60529)	IP 54
Technology / protocol	Loop AP / XP95
Relative humidity	max. 95% no condensation
Specification according to	CEA GEI 1-052 (6/97)
Weight	621 g (1.4 lbs)
Dimensions	250 x 175 x 75 mm (WxHxD) 9.8 x 6.9 x 3 inch (WxHxD)

Approvals / marking



G 202052



2531-CPR-CSP11161

Part no.: 905557

Analog addressable input/output module for monitoring dry contacts including line monitoring and for controlling outputs via relays. Version for wall-mounted installation (W). The inputs can recognize the states "quiescent", "alarm" and "fault". Applicable for operation in fire alarm panels with Loop AP protocol. Addressing via DIP switches; the address can also be modified after installation. The electronics features an integrated isolator; a fault, short circuit or open line is indicated.

Connection / mounting

Connection cable	2-wire
Recommended cable, standard	747180
JY(ST)Y-2x2x0.8 mm	
Conductor cross-section	max. 1.5 mm ² (AWG 15)
Electrostatic shielding	not required

Contact input:	
Voltage at contact input	9 - 11 V DC
Cable resistance max.	50 Ohm
End-of-line resistor EOL	20 kOhm
Alarm resistor	4.7 kOhm

Relay outputs:	
Voltage	max. 30 V DC
Current	max. 1 A DC

Note

In FMZ 5000 technique, input signals of this module type can only be used as binary signals. These signals can not be assigned to any group or detector numbers.

Connection diagram

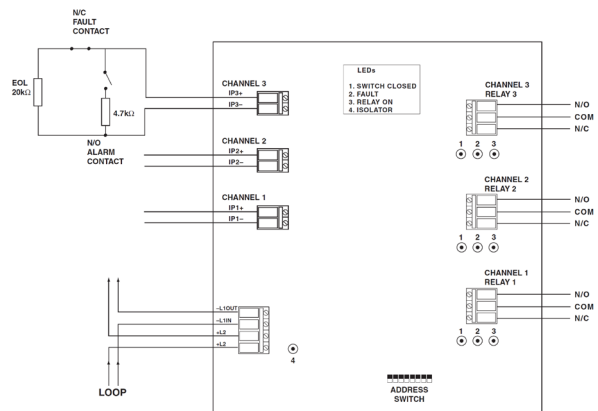

311-810_012 / A101 / 2020-May-15 / en
The contents of this publication are subject to modifications without notice. All rights reserved.





Standard detectors

Modules, addressable, wall mounting

Sounder control module SCX 852 W-I

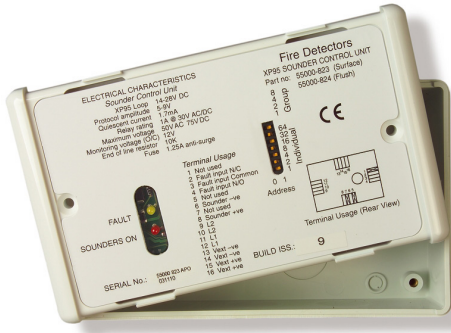

Part no.: 905560

Analog addressable sounder control module for controlling sounders in continuous or pulse-controlled operation with additional contact input for monitoring the external power supply of the sounders. Version for wall-mounted installation (W). Applicable for operation in fire alarm panels with Loop AP protocol. Addressing via DIP switches; the address can also be modified after installation. The electronics features an integrated isolator; a fault, short circuit or open line is indicated.

Technical specifications

Operating voltage	17 V - 28 V DC
Current consumption:	
Quiescent	1.9 mA
Output active	1.7 mA
Short circuit	3.6 mA
Inputs	1 (contact input)
Outputs	1
Active output indication	red LED
Fault indication	2 yellow LEDs
Integrated isolator	yes
Operating temperature	-20 °C to +70 °C (-4 °F to +158 °F)
IP rating (EN 60529)	IP 54
Technology / protocol	Loop AP / XP95
Relative humidity	max. 95% no condensation
Specification according to	CEA GEI 1-052 (6/97)
Weight	240 g (0.5 lbs)
Dimensions	150 x 90 x 48 mm (WxHxD) 5.9 x 3.5 x 1.9 inch (WxHxD)

Approvals / marking



G 201095



2531-CPR-CSP11144

Connection / mounting

Connection cable	2-wire
Recommended cable, standard	747180
JY(ST)Y-2x2x0.8 mm	
Conductor cross-section	max. 1.5 mm ² (AWG 15)
Electrostatic shielding	not required

External power supply	9 - 50 V DC
Contact input	NC/NO contact for fault of the external power supply

Relay output:	
Voltage	max. 30 V DC
Current	max. 1 A DC

Note

The output of the sounder control module operates with polarity switching. The device is connected with reversed voltage polarity. Triggering the device output activates the polarity switchover which activates the connected sounders.

Connection diagram

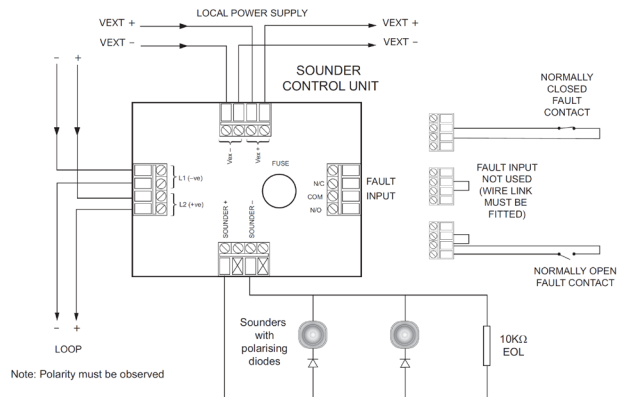



Standard detectors

Modules, addressable, wall mounting

Zone monitor unit ZMX 845 W-I

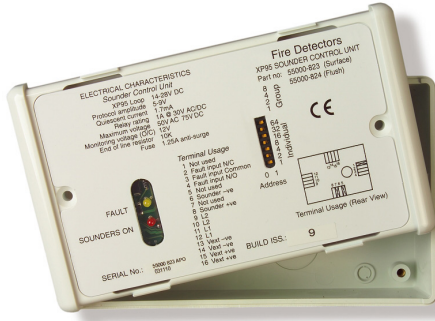

Technical specifications

Operating voltage	17 V - 28 V DC
Voltage output conventional zone	19 V ± 1 V DC or at operating voltage < 22 V = operating voltage minus 1,5 V
Current consumption: Quiescent	4.0 mA + detector
Alarm	19.0 mA + detector
Inputs	1 (conventional zone)
Outputs	0
Zone alarm indication	red LED
Fault indication	yellow LED
Integrated isolator	yes
Operating temperature	-20 °C to +70 °C (-4 °F to +158 °F)
IP rating (EN 60529)	IP 54
Technology / protocol	Loop AP / XP95
Relative humidity (IEC 721-3-3)	max. 95% no condensation
Weight	230 g (0.5 lbs)
Dimensions	150 x 90 x 48 mm (WxHxD) 5.9 x 3.5 x 1.9 inch (WxHxD)

Approvals / marking



G 201094



2531-CPR-CSP11143

Part no.: 905804

Analog addressable module for monitoring a conventional zone. Automatic detectors and manual call points using conventional technology can be connected. Version for wall-mounted installation (W). The states “quiescent”, “alarm” and “fault” can be recognized. Applicable for operation in fire alarm panels with Loop AP protocol. Addressing via DIP switches; the address can also be modified after installation. The electronics features an integrated isolator; a fault, short circuit or open line is indicated.

Connection / mounting

Connection cable	2-wire
Recommended cable, standard	747180
J-Y(ST)Y-2x2x0.8 mm	
Conductor cross-section	max. 1.5 mm ² (AWG 15)
Electrostatic shielding	not required

Limit value zone: Voltage	19 V ± 1 V DC or at Operating voltage < 22 V = Operating voltage minus 1,5 V
Terminating resistor	5.1 kOhm

Connection diagram

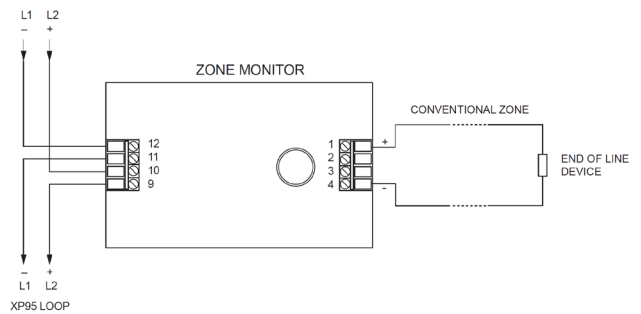

Terminals 2 (+ve) and 3 (-ve) may be used to connect a capacitor if an active end of line device is conn

311-810_015 / A102 / 2022-May-11 / en
The contents of this publication are subject to modifications without notice. All rights reserved.





Standard detectors

Modules, addressable

Input module IUX SA 100 W-I



Technical specifications

Operating voltage	17 V - 35 V DC
Current consumption:	
Quiescent	0.5 mA
Alarm (LED on)	max. 2 mA
Alarm (LED off)	0.5 mA
Short-circuit	max. 2 mA
Starting current	0.9 mA
Indication:	
Activated input	LED (IP) red
Fault	LED (IP) yellow
Isolator	LED (Poll/ISOL) yellow
Polling	LEC (Poll/ISOL) green
Operating temperature	-40 °C to +70 °C (-40 °F to 158 °F)
IP rating (EN 60529)	IP 52
Material enclosure	Polycarbonate UL94-V0
Technology/protocol	Loop AP / XP95 ¹⁾ Discovery / CoreProtocol ²⁾
Inputs	1
Outputs	0
Addresses	1
Integrated Isolator	Yes
Relative humidity	0 to 95% no condensation
Specification according to	EN 54-17, EN 54-18
Weight	239 g (0.53 lbs)
Dimensions	150 x 90 x 60 mm (WxHxD) 5.9 x 3.5 x 2.4 inch (WxHxD)

¹⁾ Protocol with FMZ 5000 / DCP-1

²⁾ Not with FMZ 5000 / DCP-1

Part no.: 925939

The analog addressable input module for wall mounting (w) monitors the status of one or more potential-free contacts and reports their status to the fire alarm control panel. The optional function (interrupt) enables the participation in a quick alarm query, similar to manual call points. The states „quiescent“, „pre-alarm“, „alarm“ and „fault“ can be recognized. The module is intended for operation with fire alarm control panels via Loop AP protocol. Addressing is done via DIP switches. The address can also be modified after installation. The electronics have an integrated isolator.

Included in delivery

Housing for surface-mounting.

Connection / mounting

Connection cable	2-wire
Recommended cable, standard	747180
J-Y(ST)Y-2x2x0.8 mm	
Conductor cross-section	max. 2.5 mm ² (AWG 12)
Electrostatic shielding	not necessary

Contact input:	
Voltage at contact input	9 V - 11 V DC
Cable resistance max.	50 Ohm
End-of-line resistor EOL	20 kOhm
Pre-alarm resistor	10 kOhm
Alarm resistor	1 kOhm

Connection diagram

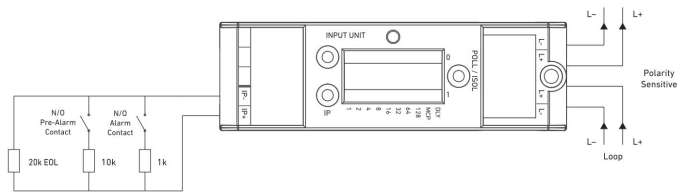

Approvals / marking



G 218035



2531-CPR-CSP11081
0832-CPR-F2368





Standard detectors

Modules, addressable

Input module IUX SA 100 W-I TWIN



Part no.: 925945

The IUX SA 100 W-I TWIN input module has two separate analog addressable input modules in one housing for wall mounting (W). The modules monitor the status of one or more potential-free contacts and report their status to the fire alarm control panel. The optional function (interrupt) enables participation in a quick alarm query, similar to manual call points. The states „quiescent“, „pre-alarm“, „alarm“ and „fault“ can be recognized. The module is intended for operation with fire alarm control panels via Loop AP protocol. Addressing is done via DIP switches. The address can also be modified after installation. The electronics have an integrated isolator.

Technical specifications

Operating voltage	17 V - 35 V DC
Current consumption per input module:	
Quiescent	0.5 mA
Alarm (LED on)	max. 2 mA
Alarm (LED off)	0.5 mA
Short-circuit	max. 2 mA
Starting current	0.9 mA
Indication:	
Activated input	LED (IP) red
Fault	LED (IP) yellow
Isolator	LED (Poll/ISOL) yellow
Polling	LEC (Poll/ISOL) green
Operating temperature	-40 °C to +70 °C (-40 °F to 158 °F)
IP rating (EN 60529)	IP 52
Material enclosure	Polycarbonate UL94-V0
Technology/protocol	Loop AP / XP95 ¹⁾ Discovery / CoreProtocol ²⁾
Inputs	2
Outputs	0
Addresses	2
Integrated isolator	Yes
Relative humidity	0 to 95% no condensation
Specification according to	EN 54-17, EN 54-18
Weight	273 g (0.6 lbs)
Dimensions	150 x 90 x 60 mm (WxHxD) 5.9 x 3.5 x 2.4 inch (WxHxD)

Included in delivery

Housing for surface-mounting

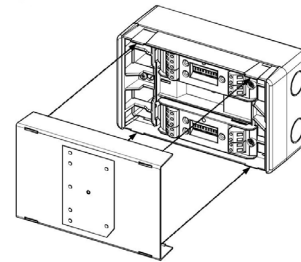

Connection / mounting

Connection cable	2-wire
Recommended cable, standard	747180
J-Y(ST)Y-2x2x0.8 mm	
Conductor cross-section	max. 2.5 mm ² (AWG 12)
Electrostatic shielding	not necessary
Contact input:	
Voltage at contact input	9 V - 11 V DC
Cable resistance max.	50 Ohm
End-of-line resistor EOL	20 kOhm
Pre-alarm resistor	10 kOhm
Alarm resistor	1 kOhm

Connection diagram

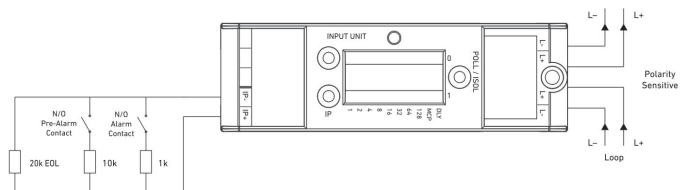

Approvals / marking



G 218037



2531-CPR-CSP11091
0832-CPR-F2370

311-810_019 / A102 / 2020-June-12 / en
The contents of this publication are subject to modifications without notice. All rights reserved.

¹⁾ Protocol with FMZ 5000 / DCP-1
²⁾ Not with FMZ 5000 / DCP-1





Standard detectors

Modules, addressable

Input module IUX SA 300 R-I



Technical specifications

Operating voltage	17 V - 35 V DC
Current consumption:	
Quiescent	0.5 mA
Alarm (LED on)	max. 2 mA
Alarm (LED off)	0.5 mA
Short-circuit	max. 2 mA
Starting current	0.9 mA
Indication:	
Activated input	LED (IP) red
Fault	LED (IP) yellow
Isolator	LED (Poll/ISOL) yellow
Polling	LED (Poll/ISOL) green
Operating temperature	-40 °C to +70 °C (-40 °F to 158 °F)
IP rating (EN 60529)	IP 52
Material enclosure	Polycarbonate UL94-V0
Technology/protocol	Loop AP / XP95 ¹⁾ Discovery / CoreProtocol ²⁾
Inputs	1
Outputs	0
Addresses	1
Integrated isolator	Yes
Relative humidity	0 to 95% no condensation
Specification according to	EN 54-17, EN 54-18
Weight	46 g (0.1 lbs)
Dimensions	102 x 33 x 33 mm (WxHxD) 4.02 x 1.3 x 1.3 inch (WxHxD)

¹⁾ Protocol with FMZ 5000 / DCP-1

²⁾ Not with FMZ 5000 / DCP-1

Part no.: 925943

The analog addressable input module for DIN rail mounting (R) monitors the status of one or more potential-free contacts and reports their status to the fire alarm control panel. The optional function (interrupt) enables participation in a quick alarm query, similar to manual call points. The states „quiescent“, „pre-alarm“, „alarm“ and „fault“ can be recognized. The module is intended for operation with fire alarm control panels via Loop AP protocol. Addressing is done via DIP switches, the address can also be changed after installation. The electronics have an integrated isolator.

Connection / mounting

Connection cable 2-wire
Recommended cable, standard 747180
J-Y(ST)Y-2x2x0.8 mm
Conductor cross-section max. 2.5 mm² (AWG 12)
Electrostatic shielding not necessary

Contact input:
Voltage at contact input 9 V - 11 V DC
Cable resistance max. 50 Ohm
End-of-line resistor EOL 20 kOhm
Pre-alarm resistor 10 kOhm
Alarm resistor 1 kOhm

Connection diagram

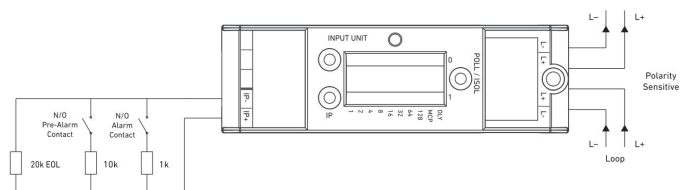

Approvals / marking



G 218036

2531-CPR-CPS11081
0832-CPR-F2368



Standard detectors

Modules, addressable

Input / output module IOX SA 103 W-I AC



Technical specifications

Operating voltage	17 V - 35 V DC
Current consumption:	
Quiescent	0.7 mA
Alarm (LED on)	max. 5.2 mA
Alarm (LED off)	0.7 mA
Short-circuit	max. 5.2 mA
Starting current	1.1 mA
Indication	
Activated input	LED (IP) red
Fault	LED (IP) yellow
Activated isolator	LED (Poll/ISOL) yellow
Activated polling	LEC (Poll/ISOL) green
Activated output	LED (RLY) red
Indication output fault	LED (RLY) yellow
Relay output:	
Voltage	max. 30 V DC / 250 V AC
Current	max. 5 A DC / AC
Operating temperature	-40 °C to +70 °C (-40 °F to 158 °F)
IP rating (EN 60529)	IP 52
Material enclosure	Polycarbonate UL94-V0
Inputs	2
Outputs	1
Addresses	1
Integrated isolator	Yes
Technology/protocol	Loop AP / XP95 ¹⁾ Discovery / CoreProtocol ²⁾
Relative humidity	0 to 95% no condensation
Specification according to	EN 54-17, EN 54-18
Weight	301 g (0.66 lbs)
Dimensions	150 x 90 x 60 mm (WxHxD) 5.9 x 3.5 x 2.4 inch (WxHxD)

¹⁾ Protocol with FMZ 5000 / DCP-1

²⁾ Not with FMZ 5000 / DCP-1

Part no.: 925941

The analog addressable input/output module for wall mounting (W) monitors the status of potential-free contacts via two inputs and reports their status to the fire alarm control panel. The states „quiescent“, „alarm“ and „fault“ are recognized. In addition, the module has a relay output (230 V AC switchable via contacts). The „Failsafe Mode“ function can be set as an option: If there is no loop line or protocol communication, the relay output is activated even without instructions from the BMZ. The module is intended for operation with fire alarm control panels via Loop AP protocol. Addressing is done via DIP switches, the address can also be changed after installation. The electronics have an integrated isolator.

Included in delivery

Housing for surface-mounting

Connection / mounting

Connection cable	2-wire
Recommended cable, standard	747180
J-Y(ST)Y-2x2x0.8 mm	
Conductor cross-section	max. 2.5 mm ² (AWG 12)
Electrostatic shielding	not necessary

Contact input:	
Voltage at contact input	9 V - 11 V DC
Cable resistance max.	50 Ohm
End-of-line resistor EOL	20 kOhm
Alarm resistor	1 kOhm

Note

The input is used as a binary input on the fire detection and suppression control panels FMZ 5000 and Clunid. It cannot be assigned to group or detector numbers.

Connection diagram

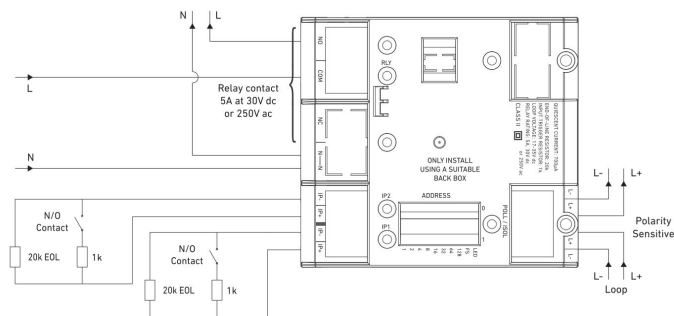

Approvals / marking



G 218040



2531-CPR-CSP11086
0832-CPR-F2369



Standard detectors

Modules, addressable

Input / output module IOX SA 102 W-I



Technical specifications

Operating voltage	17 V - 35 V DC
Current consumption:	
Quiescent	0.5 µA
Alarm (LED on)	max. 3.5 mA
Alarm (LED off)	0.5 µA
Short-circuit	max. 3.5 mA
Starting current	0.9 mA
Indication:	
Activated input	LED (IP) red
Fault	LED (IP) yellow
Activated isolator	LED (Poll/ISOL) yellow
Activated polling	LEC (Poll/ISOL) green
Activated output	LED (RLY) red
Output fault	LED (RLY) yellow
Relay output:	
Voltage	max. 30 V DC
Current	max. 1 A DC
Operating temperature	-40 °C to +70 °C (-40 °F to 158 °F)
IP rating (EN 60529)	IP 52
Material enclosure	Polycarbonate UL94-V0
Technology/protocol	Loop AP / XP95 ¹⁾ Discovery / CoreProtocol ²⁾
Inputs	1
Outputs	1
Addresses	1
Integrated isolator	Yes
Relative humidity	0 to 95% no condensation
Specification according to	EN 54-17, EN 54-18
Weight	244 g (0.54 lbs)
Dimensions	150 x 90 x 60 mm (WxHxD) 5.9 x 3.5 x 2.4 inch (WxHxD)

¹⁾ Protocol with FMZ 5000 / DCP-1

²⁾ Not with FMZ 5000 / DCP-1

Part no.: 925940

The analog addressable input/output module for wall mounting (W) monitors the status of potential-free contacts via two inputs and reports their status to the fire alarm control panel. The states „quiescent“, „alarm“ and „fault“ are recognized. In addition, the module has a relay output. The „Failsafe Mode“ function can be set as an option: If there is no loop line or protocol communication, the relay output is activated even without instructions from the BMZ. The module is intended for operation with fire alarm control panels via Loop AP protocol. Addressing is done via DIP switches, the address can also be changed after installation. The electronics have an integrated isolator.

Included in delivery

Housing for surface-mounting

Connection / mounting

Connection cable	2-wire
Recommended cable, standard	747180
J-Y(ST)Y-2x2x0.8 mm	
Conductor cross-section	max. 2.5 mm ² (AWG 12)
Electrostatic shielding	not necessary

Contact input:

Voltage at contact input	9 V - 11 V DC
Cable resistance max.	50 Ohm
End-of-line resistor EOL	20 kOhm
Alarm resistor	1 kOhm

Note

The input is used as a binary input on the fire detection and suppression control panels FMZ 5000 and Clunid. It cannot be assigned to group or detector numbers.

Connection diagram

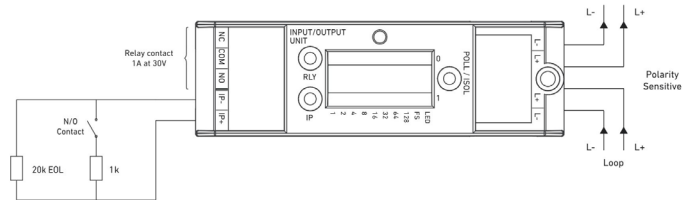

Approvals / marking



G 218038



2531-CPR-CSP11081
0832-CPR-F2368



Standard detectors

Modules, addressable

Input / output module IOX SA 104 W-I TWIN

Part no.: 925942



The input/output module IOX SA 104 W-I TWIN has two separate analog addressable input/output modules in one housing for wall mounting (W). The modules monitor the status of one or more potential-free contacts and report their status to the fire alarm control panel. The states „quiescent“, „alarm“ and „fault“ are recognized. In addition, both modules have a relay output. The 'Failsafe Mode' function can be optionally set: If there is no loop line or protocol communication, the relay output is activated, even without an instruction from the fire alarm control panel. The module is intended for operation with fire alarm control panels via Loop AP protocol. Addressing is done via DIP switches, the addresses can also be changed after installation. The electronics have integrated isolators.

Technical specifications

Operating voltage	17 V - 35 V DC
Current consumption per input/output module:	
Quiescent	0.5 mA
Alarm (LED on)	max. 3.5 mA
Alarm (LED off)	0.5 mA
Short-circuit	max. 5.2 mA
Starting current	0.9 mA
Indication:	
Activated input	LED (IP) red
Fault	LED (IP) yellow
Activated isolator	LED (Poll/ISOL) yellow
Activated polling	LEC (Poll/ISOL) green
Activated output	LED (RLY) red
Output fault	LED (RLY) yellow
Relay output:	
Voltage	max. 30 V DC
Current	max. 1 A DC
Operating temperature	-40 °C to +70 °C (-40 °F to 158 °F)
IP rating (EN 60529)	IP 52
Material enclosure	Polycarbonate UL94-V0
Inputs	2
Outputs	2
Addresses	2
Integrated isolator	Yes
Technology/protocol	Loop AP / XP95 ¹⁾ Discovery / CoreProtocol ²⁾
Relative humidity	0 to 95% no condensation
Specification according to	EN 54-17, EN 54-18
Weight	281 g (0.62 lbs)
Dimensions	150 x 90 x 60 mm (WxHxD) 5.9 x 3.5 x 2.4 inch (WxHxD)

Included in delivery

Housing for surface-mounting

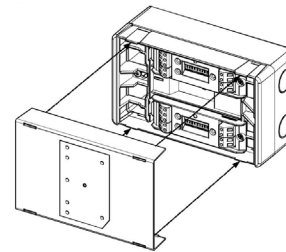

Connection / mounting

Connection cable	2-wire
Recommended cable, standard	747180
J-Y(ST)Y-2x2x0.8 mm	
Conductor cross-section	max. 2.5 mm ² (AWG 12)
Electrostatic shielding	not necessary
Contact input:	
Voltage at contact input	9 V - 11 V DC
Cable resistance max.	50 Ohm
End-of-line resistor EOL	20 kOhm
Alarm resistor	1 kOhm

Note

The input is used as a binary input on the fire detection and suppression control panels FMZ 5000 and Clunid. It cannot be assigned to group or detector numbers.

Connection diagram

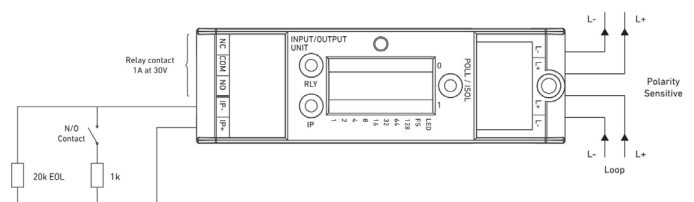

Approvals / marking



G 218034



2531-CPR-CSP11091
0832-CPR-F2370



Standard detectors

Modules, addressable

Input / output module IOX SA 302 R-I



Part no.: 925944

The analog addressable input module for DIN rail mounting (R) monitors the status of one or more potential-free contacts and reports their status to the fire alarm control panel. The optional function (interrupt) enables participation in a quick alarm query, similar to manual call points. The states „quiescent“, „pre-alarm“, „alarm“ and „fault“ can be recognized. The module is intended for operation with fire alarm control panels via Loop AP protocol. Addressing is done via DIP switches, the address can also be changed after installation. The electronics have integrated isolators.

Technical specifications

Operating voltage	17 V - 35 V DC
Current consumption:	
Quiescent	0.5 mA
Alarm (LED on)	max. 3.5 mA
Alarm (LED off)	0.5 mA
Short-circuit	max. 3.5 mA
Starting current	0.9 mA
Indication:	
Activated input	LED (IP) red
Fault	LED (IP) yellow
Isolator	LED (Poll/ISOL) yellow
Activated polling	LED (Poll/ISOL) green
Activated output	LED (RLY) red
Activated fault	LED (RLY) yellow
Relay output:	
Voltage	max. 30 V DC
Current	max. 1 A DC
Inputs	1
Outputs	1
Addresses	1
Integrated isolator	yes
Operating temperature	-40 °C to +70 °C (-40 °F to 158 °F)
Material enclosure	Polycarbonate UL94-V0
Technology/protocol	Loop AP / XP95 ¹⁾ Discovery / CoreProtocol ²⁾
Relative humidity	0 to 95% no condensation
Specification according to	EN 54-17, EN 54-18
Weight	49 g (0.11 lbs)
Dimensions	102 x 33 x 33 mm (WxHxD) 4.02 x 1.3 x 1.3 inch (WxHxD)

¹⁾ Protocol with FMZ 5000 / DCP-1

²⁾ Not with FMZ 5000 / DCP-1

Included in delivery

Housing for surface-mounting

Connection / mounting

Connection cable 2-wire
Recommended cable, standard 747180
J-Y(ST)Y-2x2x0.8 mm
Conductor cross-section max. 2.5 mm² (AWG 12)
Electrostatic shielding not necessary

Contact input:
Voltage at contact input 9 V - 11 V DC
Cable resistance max. 50 Ohm
End-of-line resistor EOL 20 kOhm
Alarm resistor 1 kOhm

Note

The input is used as a binary input on the fire detection and suppression control panels FMZ 5000 and Clunid. It cannot be assigned to group or detector numbers.

Connection diagram

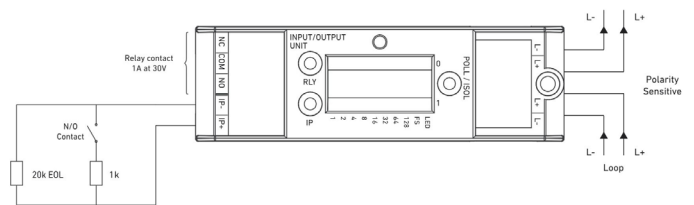

Approvals / marking



G 218039



2531-CPR-CSP11081
0832-CPR-F2368





Standard detectors

Modules, addressable

Monitoring module SUX5000 AP NFC

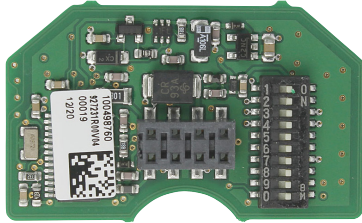

Product features

- Integration into the switching device to be monitored
- Ring bus integration
- Address assignment via NFC using the App "LoopAssign" on mobile devices
- Addressing via DIP switches on the module (alternatively)
- Monitored signal path
- Special applications: connection to external contact, connection of LEDs, hardware fault signal suppression

Technical specifications

Operating voltage	17 V - 28 V DC
Rated voltage	24 V DC
Quiescent current	360 μA_{eff}
Starting current	500 mA, max. 150 ms
Operating current	2.3 mA (LED)
Integrated isolator	no
Technology/Protocol	Loop AP/XP95
Operating temperature	-40 °C to +80 °C (-40 °F to +176 °F)
Weight	approx. 4 g (0.01 lbs)
Dimensions	38.5 x 23 x 7.4 mm (WxHxD) 1.5 x 0.9 x 0.3 inch (WxHxD)

Part no.: 927799

The SUX5000 AP NFC is a monitoring module for the installation of fault and alarm signal transmitters in two-wire loop systems with individual identification. It allows the individual addressing of dry contactors such as pressure switches, limit switches, float switches or temperature switches, with plain text information to FMZ 5000/DCP-1 or Loop AP-compatible fire alarm systems. Addressing is done via of DIP switches or the Android App "LoopAssign". The Monitoring module SUX5000 AP NFC has an NFC interface for contactless configuration of the module and its address on the Loop AP.

Application

Use in monitoring switches

Included in delivery

1 Packaging unit (5 pcs.)

Not included in delivery

Fault- or alarm device

Optional accessories

Android App "LoopAssign"

Approvals / marking



G 208059



0786-CPR-20416



Standard detectors

Modules, addressable, DIN rail mounting

Input unit IUX 765 M-I



Technical specifications

Operating voltage	17 V - 28 V DC
Current consumption at 24 V DC:	
Min. (quiescent)	0.2 mA
Max. (alarm input)	3.6 mA
Inputs	1
Outputs	0
Alarm indication	red LED
Bus activity indication	green LED
Short-circuit indication on the loop or fault of the monitors input	yellow LED
Integrated isolator	yes
Operating temperature	0 °C to +38 °C (+32 °F to +100 °F)
Technology / protocol	Loop AP / XP95
Relative humidity	0 to 95% no condensation
Weight	30 g (0.1 lbs)
Dimensions	39 x 39 x 18 mm (WxHxD) 1.5 x 1.5 x 0.7 inch (WxHxD)

Approvals / marking



Part no.: 4000954

Miniature interface for use in devices with little space. The miniature input unit monitors the state of one or more dry normally open contacts and reports the status to a fire detection and suppression control panel. Applicable for operation in fire alarm control panels with Loop AP protocol. Optional equipped with interrupt for rapid alarm signals like a manual call point. The states "quiescent", "pre-alarm", "alarm" and "fault" can be recognized. Addressing via DIP switches, the address can also be modified after installation.

Connection / mounting

Connection cable	2-wire
Recommended cable, standard	747180
JY(ST)Y-2x2x0.8 mm	
Conductor cross-section	max. 1,5 mm ² (AWG 15)
Electrostatic shielding	not required

Contact input:	
Voltage at contact input	9 - 11 V DC
Cable resistance max.	50 Ohm
End-of-line resistor EOL (R3)	20 kOhm
Pre-alarm resistor (R2)	10 kOhm
Alarm resistor (R1)	short circuit

Connection diagram

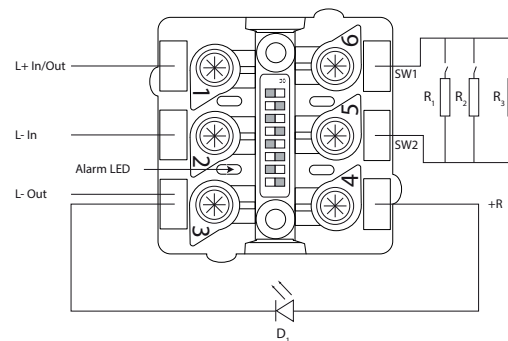



Standard detectors

Modules, conventional

Card LÖ leakage detector

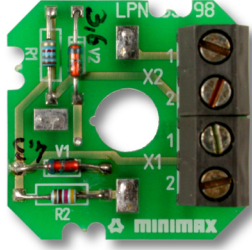

Part no.: 800707

Monitoring card for connection of LKM2001 flow detector to FMZ 4100 and FMZ 5000 control units.

Connection / mounting

Connection cable	2-wire
Recommended cable, standard	747180
J-Y(ST)Y-2x2x0.8 mm	
Conductor cross-section	
max. 2.5 mm ² (AWG 13), solid conductor	
max. 1.5 mm ² (AWG 15), strand with wire end sleeve	
Cable length	max. 700 m (0.43 miles), at Ø 0.8 mm (0.03 inch) lead

Technical specifications

Number of leak detectors per line	max. 10
Operating temperature	-20 °C to +60 °C (-4 °F to +140 °F)
Weight	10 g (0.02 lbs)
Dimensions	28 x 28 mm (LxW) 1.1 x 1.1 inch (LxW)

Approvals / marking



Card MVA LÖ



Part no.: 782239

Module for monitoring the feed cable and the solenoid of a solenoid valve for wire break and short circuit. The card is integrated in the valve connection box. Monitoring and triggering must be carried out with a primary control group.

Connection / mounting

Connection cable	2-wire
Recommended cable, standard	747180
J-Y(ST)Y-2x2x0.8 mm	
Conductor cross-section	
max. 2.5 mm ² (AWG 13), solid conductor	
max. 1.5 mm ² (AWG 15), strand with wire end sleeve	

Technical specifications

Input voltage:	
- Triggering	17 V - 29 V DC
- Monitoring	0 V - 10 V DC
Current carrying capacity	max. 2 A
Rated capacity of the solenoid valve at 24 V	max. 38 W
Display, triggering	1 LED red
Operating temperature	-20 °C to +60 °C (-4 °F to +140 °F)
Weight	10 g (0.02 lbs)
Dimensions	28 x 28 mm (LxW) 1.1 x 1.1 inch (LxW)

Approvals / marking





Standard detectors

Modules, conventional

MVA LÖ redundant card

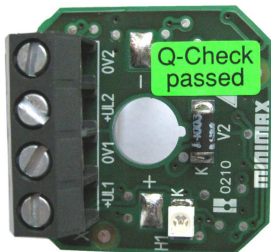

Technical specifications

Input voltage	
- Activation	17 V - 29 V DC
- Monitoring	0 V - 10 V DC
Current carrying capacity	max. 2 A
Power rating of solenoid valve at 24 V	max. 38 W
Anzeige, Ansteuerung	1 LED red
Operating temperature	-20 °C to + 50 °C (-4 °F to +122 °F)
Weight	10 g (0.02 lbs)
Dimensions	28 x 28 mm (LxW) 1.1 x 1.1 inch (LxW)

Part no.: 904585

Using the monitoring module the feed lines to the coil of a solenoid valve or trigger magnets are monitored for discontinuity and short circuit and whether the coil is connected. The module must be used for monitoring when a trigger element in a fire extinguishing system is responsible for several extinguishing zones and therefore the control and the feed lines have to be solved in a redundant design. The module must be used within the connection housing of the valve.

Connection / mounting

Recommended cable 2-wire
Conductor cross-section
max. 2.5 mm² (AWG 13), solid conductor
max. 1.5 mm² (AWG 15), flexible wire with ferrule

Note

To monitor and control the triggering, two control groups of two different control group modules must be used.

Approvals / marking



Card module sounder

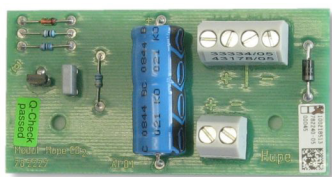

Technical specifications

Input voltage:	
- Triggering	19 V - 29 V DC
- Monitoring	0 V - 10 V DC
Current carrying capacity	max. 0.5 A
Operating temperature	-20 °C to +60 °C (-4 °F to +140 °F)
Weight	20 g (0.04 lbs)
Dimensions	80 x 40 mm (LxB) 3.2 x 1.6 inch (LxB)

Part no.: 782240

Module for monitoring the feed cable of an optical and acoustic alarm device for wire break and short circuit. The card must be installed into the housing of each alarm device.

Connection / mounting

Connection cable 2-wire
Recommended cable, standard 747180
J-Y(ST)Y-2x2x0.8 mm
Conductor cross-section
max. 2.5 mm² (AWG 13), solid conductor
max. 1.5 mm² (AWG 15), strand with wire end sleeve

Approvals / marking





Standard detectors

Modules, conventional

Card MVA impulse



Part no.: 800112

Module for monitoring the feed cable and the solenoid of a 2/2-way solenoid valve of the impulse type for wire break and short circuit. The „NC solenoid“ is also connected to the card. The card is integrated in the valve connection box. Monitoring and triggering must be carried out with a primary control group.

Connection / mounting

Connection cable
Recommended cable, standard
J-Y(ST)Y-2x2x0.8 mm
Conductor cross-section
max. 2.5 mm² (AWG 13), solid conductor
max. 1.5 mm² (AWG 15), strand with wire end sleeve

3-wire
747180

Technical specifications

Input voltage:	
- Triggering	19 V - 29 V DC
- Monitoring	0 V - 10 V DC
Current carrying capacity	max. 2 A
Display, triggering	1 LED red
Operating temperature	-20 °C to +60 °C (-4 °F to +140 °F)
Weight	10 g (0.02 lbs)
Dimensions	28 x 28 mm (LxB) 1.1 x 1.1 inch (LxB)

Approvals / marking





Standard detectors

Test equipment

Multifunction tester S1000 Smoke & heat detector



Product features

- Generation of smoke and heat during only one test run
- Easier and quicker maintenance procedure
- Used for optical smoke detectors, ionisation smoke detectors and heat detectors (differential and maximum detectors)
- Reduction of testing periods
- Increased testing capacity of the smoke capsules
- Automatic infrared identification of the detector
- Color code LED for feedback to the operator
- Top adjustable in several positions
- Optimized method for smoke generation

Technical specifications

IP rating	IP 20
Working temperature	+5 °C to +45 °C (+41 °F to +113 °F)
Storage temperature	-10 °C to +50 °C (+14 °F to +122 °F)
Relative humidity (IEC 721-3-3)	max. 85 % no condensation
Weight	750 g (1.7 lbs)
Dimensions	153 x 397 mm (WxH) 6 x 15.6 inch (WxH)

Part no.: 908595

The multi-stimulus detector tester S1000 is intended for the functional testing of point-type fire detectors with single or multiple sensors. As the test of different detector types can be conducted with one test tool, it is no longer necessary to switch between several test tools. The substances releasing smoke and heat are generated in the test tool. The test tool is suitable for all optical smoke detectors, ionization detectors and heat detectors (differential and maximum detectors). The test of the different sensors can be conducted either individually, successively or simultaneously for all of them at once. The required stimulus in each case is generated at the time of the test from the corresponding smoke capsule. The multilingual selection of the testing stimuli, as well as their combination and sequence is menu-driven via the navigation keys and displayed on the screen. Compared to the aerosol cans the smoke capsule offers higher test capacities.

Included in delivery

- 1 Smoke and heat detector tester head unit only
- 1 Smoke capsule

Note

Only heat detectors with a release temperature of up to 60 °C (140 °F) are testable.

Approvals / marking





Standard detectors

Test equipment

Multifunction test set S1001 Smoke & heat detector



Product features

- Generation of smoke and heat during only one test run
- Easier and quicker maintenance procedure
- Used for optical smoke detectors, ionization smoke detectors and heat detectors (differential and maximum detector)
- Reduction of testing periods
- Increased testing capacity of the smoke capsules
- Automatic infrared identification of the detector
- Colour code LED for feedback to the operator
- Top adjustable in several positions
- Optimized method for smoke generation

Technical specifications

Battery charging time	75 - 90 min.
Battery baton	7.2 V 2.2 Ah
IP rating	IP 20
Working temperature	+5 °C to +45 °C (+41 °F to +113 °F)
Storage temperature	-10 °C to +50 °C (+14 °F to +122 °F)
Relative humidity (IEC 721-3-3)	max. 85 %, no condensation
Weight	1250 g (2.8 lbs)
Dimensions	153 x 397 mm (WxH) 6 x 15.4 inch (WxH)

Part no.: 908596

The multi-stimulus detector tester kit S1001 is intended for the functional testing of point-type fire detectors with single or multiple sensors. As the test of different detector types can be conducted with one test tool, it is no longer necessary to switch between several test tools. The substances releasing smoke and heat are generated in the test tool. The test tool is suitable for all optical smoke detectors, ionization detectors and heat detectors (differential and maximum detectors). The test of the different sensors can be conducted either individually, successively or simultaneously for all of them at once. The required stimulus in each case is generated at the time of the test from the corresponding smoke capsule. The multilingual selection of the testing stimuli, as well as their combination and sequence, is menu-driven via the navigation keys and displayed on the screen. Compared to the aerosol cans the smoke capsule offers higher test capacities.

Included in delivery

- 1 Smoke and heat detector tester head unit only
- 1 Smoke capsule
- 2 battery packs 3000 mAh / 7.2 V
- 1 Rapid charger 100 - 240 V AC; 13.8 V DC

Note

Only heat detectors with a release temperature of up to 60 °C (140 °F) are testable.

Approvals / marking





Standard detectors

Test equipment

Smoke detector test kit S811



Product features

- Universal gripper for removing / mounting detectors
- Telescopic poles for working heights of up to 6 m (374 inch)
- Smoke detector tester for optical and ionization smoke detectors

Technical specifications

Adjustment range of three-point gripper	65 mm to 110 mm (2.56 inch to 4.33 inch)
Max. working height	approx. 6 m (236.22 inch)
Working temperature	+10 °C to +45 °C (+50 °F to +95 °F)
Storage temperature	-10 °C to +50 °C (+14 °F to +122°F)
Weight	3310 g (7.3 lbs)
Size of bag for telescopic poles	100 x 1290 mm (dia. x L) 3.93 x 50.78 inch (dia. x L)
Size of device bag	510 x 440 x 270 mm (WxHxD) 20.1 x 17.3 x 10.6 inch (WxHxD)

Part no.: 906946

The universal device kit includes everything needed for removing, inserting and testing smoke detectors. Extendable fiberglass poles are for testing and installing detectors up to a height of approx. 6 m. By adjusting the three-point gripper a six-stage division for different detector diameters is possible. The smoke detector testing device can be used with the Test gas Solo A5 for all smoke detectors. The swivel frame also facilitates the testing of detectors that are difficult to access. The Test gas is released by touch, with a patented membrane allowing the efficient use of the gas. The Test gas is designed for use with the smoke detector testing device to test ionization and optical smoke detectors. Features of the Test gas include reliable test triggering of the detectors, residue-free use, rapid clearing and low consumption.

Included in delivery

- 1 Telescopic pole 4.5 m (177.16 inch)
- 1 Detector removal tool
- 1 Smoke detector testing device
- 2 Carrying bags

Not included in delivery

Test gas Solo A5

928316



Standard detectors

Test equipment

Heat detector test kit S461



Product features

- Heat radiation without an open flame
- Battery operated
- Rapid battery charger for 230V AC or 12V DC on-board power supply
- Red and green LEDs for testing status indication
- Testing time limit of max. 120 seconds
- Internal fan cools down heating element
- Energy efficiency mode, automatic shutdown after 5 minutes of inactivity

Technical specifications

Capacity	50 tests, 30 seconds each
Rapid battery charge	75 - 90 minutes
Working temperature	+5 °C to +45 °C (+41 °F to +113 °F)
Storage temperature	-10 °C to +50 °C (+14 °F to +122 °F)
Relative humidity (IEC 721-3-3)	max. 85 %, no condensation
Weight	1100 g (2.4 lbs)
Dimensions	135 x 330 mm (dia. x L) 5.3 x 13 inch (dia. x L)

Part no.: 901340

Fully automated, battery-operated heat detector testing device. Easy to use and energy-saving thanks to activation of the heating process when the testing device is placed on the detector. The detector test is carried out completely flame-free through the use of a warm stream of air horizontal to the testing head cup. This stream of air comes into direct contact with the sensor chamber, allowing the detector's alarm to be triggered rapidly and in a reproducible manner.

Included in delivery

- 1 Heat detector testing device
- 2 Batteries 3000 mAh / 7.2 V
- 1 Rapid charger 100 - 240 V AC; 13.8 V DC

Not included in delivery

Adapter WMX5000 heat detector test device 923818



Standard detectors

Test equipment

Smoke & heat detector test kit S823



Product features

- Universal gripper for removing / mounting detectors
- Heat detector test, battery-operated, without an open flame
- Telescopic poles for working heights of up to 9.3 m (366 inch)
- Smoke detector tester for optical and ionization smoke detectors

Technical specifications

Adjustment range of three-point gripper	65 mm to 110 mm (2.56 inch to 4.33 inch)
Dimensions of heat detector tester	135 x 330 mm (dia. x L) 5.3 x 13 inch (dia. x L)
Capacity heat detector tester	50 tests, 30 seconds each
Rapid battery charge	75 - 90 minutes
Max. working height	approx. 9.3 m (366 inch)
Working temperature	+10 °C to +35 °C (+50 °F to +95 °F)
Storage temperature	-10 °C to +50 °C (+14 °F to +122 °F)
Relative humidity (IEC 721-3-3)	max. 85 %, no condensation
Weight	3300 g (7.3 lbs)
Size of bag for telescopic poles	100 x 1290 mm (dia. x L) 3.93 x 50.78 inch (dia. x L)
Size of device bag	510 x 440 x 270 mm (WxHxD) 20.1 x 17.3 x 10.6 inch (WxHxD)

Part no.: 906948

The complete device kit includes everything needed for removing, replacing and testing smoke and heat detectors. Extendable fiberglass poles are for testing and installing detectors up to a height of approx. 9.3 m (366 inch).

By adjusting the three-point gripper a six-stage division for different detector diameters is possible.

The detector test is carried out completely flame-free through the use of a warm stream of air horizontal to the testing head cup. This stream of air comes into direct contact with the sensor chamber, allowing the detector's alarm to be triggered rapidly and in a reproducible manner.

The smoke detector testing device can be used with the Test gas Solo A5 for all smoke detectors. The Test gas is released by touch, with a patented membrane allowing the efficient use of the gas.

The Test gas is designed for use with the smoke detector testing device to test ionization and optical smoke detectors. Features of the Test gas include reliable test triggering of the detectors, residue-free use, rapid clearing and low consumption.

Included in delivery

- 3 Telescopic poles 1.1 m (43.30 inch)
- 1 Telescopic pole 4.5 m (177.16 inch)
- 1 Detector removal tool
- 1 Smoke detector testing device
- 1 Heat detector testing device
- 2 Batteries 3000 mAh / 7.2 V
- 1 Rapid charger 100 - 240 V AC; 1.8 V DC
- 2 Carrying bags

Not included in delivery

Test gas Solo A5

928316



Standard detectors

Test equipment

Test clamp WMX D

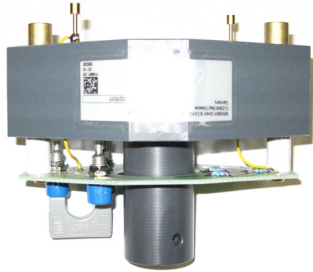

Part no.: 719857

Function test of differential/maximum heat detectors of open design (WMX type D).

Note

This procedure is a substitute for a coarse heat test, as the release resistance is adapted to the specific type and a detector would not respond if the heat detector or any other important component is defective.

Not included in delivery

Pipe extension service devices 756549

Technical specifications

Weight	380 g (0.8 lbs)
Dimensions	75 x 118 x 85 mm (LxWxH) 3 x 4.7 x 3.4 inch (LxWxH)

Test unit removal tool

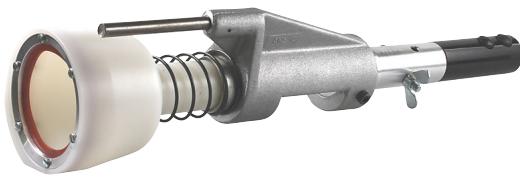

Part no.: 835752

Included in delivery

Test unit removal tool
Husked bushing
Removal tool adapter

Not included in delivery

Telescope rod 2.5 m (8.2 ft) 906951
Telescope rod 4.5 m (14.8 ft) 901345

Technical specifications

Weight	800 g (1.8 lbs)
--------	-----------------

Adaptation set

Part no.: 920895

Easy adaptation of the Test unit removal tool to the Solo telescope rod until year of construction 7/2015.

Included in delivery

Husked bushing
Removal tool adapter
1 Cylinder head screw M6
1 Wing nut M6

Not included in delivery

Test unit removal tool 835752
Telescope rod 906951

Technical specifications

Weight	450 g (1.0 lbs)
--------	-----------------



Standard detectors

Test equipment

Smoke pen



Part no.: 921014

Test equipment for smoke detectors and aspirating smoke detectors. Smoking duration approx. 30 min. per smoke stick.

Included in delivery

1 Smoke pen
6 Smoke sticks

Spare parts

6 Smoke sticks

921015

Technical specifications

Weight	44 g (0.1 lbs)
Dimensions	150 x 13 mm (LxD) 5.9 x 0.5 inch (LxD)



Standard detectors

Test equipment

Test Set Loop AP



Product features

- View and control of the loop devices
- Enables loop integrity and diagnostics testing during commissioning and maintenance
- Internal battery
- Touch screen display
- Works with loop devices of the XP95, Discovery and CoreProtocol series

Technical specifications

Technology / protocol	CoreProtocol, Discovery, XP95
Power supply	Power supply unit 12 V DC or Lithium-Ion battery
Battery charging time	approx. 3 h
Operating temperature	0 °C to +40 °C (+32 °F to +104 °F)
Relative humidity	max. 95 % no condensation
Weight	935 g (2.06 lbs)
Dimensions	165 x 215 x 50 mm (LxWxH) 6.5 x 8.5 x 2.0 mm (LxWxH)

Part no.: 931386

The Test Set Loop AP is a portable test unit featuring a touch screen display capable of providing several functions in interrogating and controlling all devices connected to the unit, either individual devices or complete circuits of analogue addressable Apollo series devices (CoreProtocol, Discovery and XP95).

Note

The Test Set Loop AP is designed for indoor use only and should not be subjected to harsh environments. Designed for use in non-hazardous areas with low dust exposure, moderate and stable temperature and constant humidity.

Included in delivery

- Test Set Loop AP
- Power supply unit (universal)
- Lithium-ion batteries
- 7 connector cables
- Mounting base
- Quick start guide (english)

Approvals / markings





Standard detectors

Test equipment

Battery charger SOLO 727



Technical specifications

Input voltage	100-240 V AC/60 Hz, 0.6 A
Fast charge capacity	8,4 V DC 3 A
Operating temperature	+10 °C to +35 °C (+50 °F to +95 °F)
Relative humidity	0 to 90 % no condensation
Status: battery test (approx. 5 min.) fast charging ready for use battery defective	LED flashing red/green LED red LED green LED flashing red
Weight: unpacked packed with cables connected	430 g (0.95 lbs) 294 g (0.65 lbs)
Dimensions (without cables)	134 x 55 x 30 mm (LxWxH) 5.28 x 2.17 x 1.18 inch (LxWxH)

Part no.: 931856

Fast battery charger for battery SOLO 770.

Spare part for:

Multifunction tester S1000	Smoke & heat detector	908595
Multifunction test set S1001	Smoke & heat detector	908596
Heat detector test kit S461		901340
Smoke & heat detector test kit S823		906948

Note

The quick charger SOLO 727 does not charge the battery S760 (obsolete)! Incorrect assignment will not cause any damage.

Approvals / marking



Battery SOLO 770

Technical specifications

Capacity	3.0 Ah / 7.2 V
Operating temperature	+5 °C to +45 °C (+41 °F to +113 °F)
Relative humidity	0 to 90 % no condensation
Weight: packed unpacked	550 g (1.21 lbs) 500 g (1.1 lbs)
Dimensions	28 x 490 mm (DxL) 1.1 x 19.29 inch (DxL)

Part no.: 931857

Battery for test equipment. Compatible with Battery charger SOLO 727.

Spare part for:

Multifunction tester S1000	Smoke & heat detector	908595
Multifunction test set S1001	Smoke & heat detector	908596
Heat detector test kit S461		901340
Smoke & heat detector test kit S823		906948

Approvals / marking





Standard detectors

Test equipment, accessories

Telescopic pole 1.1 m (43 inch) Part no.: 901344

Telescopic pole 2.5 m (98 inch) Part no.: 906951

Telescopic pole 4.5 m (177 inch) Part no.: 901345

Protective carrying and storage bag S610 Part no.: 906952

Silicone membrane for testing cup Part no.: 906949
For S834, S811, S461 and S823

Aerosol retaining cup Part no.: 906950
For S834, S811 and S823

Detector removal tool Part no.: 906955

Test gas Solo A5 Part no.: 928316
For S330, S811, S823

Smoke capsule Part no.: 908597
For S1000 and S1001

Universal detector removal tool S200 Part no.: 922506

Test fire mat type 1640 Part no.: 723014

Technical specifications

Material	PU foam
Gaseous combustion products:	
Carbon dioxide,	
Carbon monoxide	1.55 Vol.%, 1.21 Vol.%
Methane, Ethane	0.41 Vol.%, 0.02 Vol.%
Propane, Ethylene	0.01 Vol.%, 0.21 Vol.%
Propylene, Acetylen	0.11 Vol.%, 0.03 Vol.%
Hydrochlorid acid,	
Fluoride acid	not
Nitrous gases	0.035 mg/l
Ammonia and Organic bases,	
traces of Hydrocyamic acid	0.16 mg/l
Weight	70 g (0.15 lbs)
Dimensions	500 x 400 x 20 mm (WxHxD) 19.68 x 15.74 x 0.78 inch (WxHxD)

Operational test

Not included in delivery

Base e.g. aluminum foil

Note

Customers permission for burning the mat required.
Aerosols may effect electronic devices. Pollution of magnetic mass storages.



Industrial detectors

Chapter 07













Industrial detectors

UniVario – Versatile in application

UniVario Industrial Fire Detectors

UniVario industrial fire detectors are intelligent, platform-based, microprocessor-controlled fire detectors with a robust housing and assembly technology for even the harshest working conditions. Thanks to their modular design and use of the latest signal processing technology, these devices meet individual specifications in an extraordinarily wide range of uses. For example, they can be used indoors and outdoors, in the immediate vicinity of the protected facility or from greater distances, in clean rooms or areas as well as in extremely dirty process conditions.

Detector variant	Standard	3GD (Zone 2/22)	Ex (Zone 1/2/20/21/22)
Type of detector			
Ultraviolet flame detector	FMX5000 UV 	FMX5000 UV 3GD 	
3-channel infrared flame detector	FMX5000 IR 	FMX5000 IR 3GD 	FMX5000 IR Ex 
Standard heat detector (single hole mounting)	WMX5000 	WMX5000 3GD 	WMX5000 Ex 
High-temperature heat detector (also with flexible sensor rod - FS flex)	WMX5000 FS 	WMX5000 FS 3GD 	WMX5000 FS Ex 

UniVario FMX5000 IR

Despite the disturbance sources typical for industrial applications, the UniVario FMX5000 IR is extremely fast at detecting flames. Hot machine surfaces, direct sun radiation in exterior surroundings and welding operations are filtered by a special sensor combination and intelligent processing, while at the same time even the very small flames of an emerging fire are reliably detected and signaled as an alarm.

With its three-way optics test, whereby all three sensors as well as the optical detector window are monitored, the UniVario FMX5000 IR is extremely fail-safe.

UniVario FMX5000 UV

The flame detector FMX5000 UV reacts to optical radiation and analyzes specific wavelengths. It is installed wherever open flames are likely to develop quickly. Its perfect combination of early detection, high sensitivity, reliability, and the lowest possible risk of false alarms caused by thunderstorms, hot surfaces, or strong solar radiation make the UniVario fire detector indispensable for preventing the rapid spread of fires.

UniVario WMX5000

The WMX5000 is designed to detect open fires where temperature is increasing rapidly, such as in the case of highly combustible solids, liquids, and gases. It responds instantaneously to any rapid rise in temperature or as soon as a pre-programmed temperature is exceeded. It offers a number of different installation options, making it suitable for monitoring rooms as well as processes.

UniVario WMX5000 FS

The WMX5000 FS heat detector is specially designed to work in temperatures of up to 850 °C (1562 °F). Its heat sensor enables simple and flexible installation. A microcontroller monitors the function and analyzes temperature values. With its tough, sealed housing, the WMX5000 FS can be used in all sorts of scenarios. Optimum results are provided even when subjected to extreme temperature fluctuations, heavy soiling and aggressive conditions.



Industrial detectors

UniVario – Versatile in application

Overview accessories UniVario

Flame detectors

Flame detectors						
	Base M16 & M20	Base M16 & M20 Ex	Base M20 x 1,5 NG Ex *	Base NPT *	Base LCD	Base + Isolator
FMX5000 IR	✓	✗	✓	✓	✓	✓
FMX5000 IR HR	✓	✗	✗	✗	✗	✗
FMX5000 IR 3GD 3GD 	✗	✓	✓	✓	✗	✗
FMX5000 IR Ex 2G 1D 	✗	✓	✓	✓	✗	✗
FMX5000 UV	✓	✗	✓	✓	✓	✓
FMX5000 UV 3GD 3GD 	✗	✓	✓	✓	✗	✗

* Cable gland is not included in delivery

Flame detectors									
	Bracket	Console	Relay module	Comms. module	Relay module 3GD	Comms. module Ex	Service device	Ex barrier	Air shield (plastic)
FMX5000 IR	✓	✓	✓	✓	✗	✗	✓	✗	✓
FMX5000 IR HR	✓ Bügel HR	✗	✓	✓	✗	✗	✓	✗	✗
FMX5000 IR 3GD 3GD 	✓	✓	✗	✓	✓	✗	✓ ^{*1}	✗	✓
FMX5000 IR Ex 2G 1D 	✓	✓	✗	✗	✗	✓	✗	✓	✓
FMX5000 UV	✓	✓	✓	✓	✗	✗	✓	✗	✗
FMX5000 UV 3GD 3GD 	✓	✓	✗	✓	✓	✗	✓ ^{*1}	✗	✗

*1) The service device must not be used in explosion hazardous zones.

312-010_001 / A108 / 2020-Nov-09 / en
The contents of this publication are subject to modifications without notice. All rights reserved.

Trusted above all.

Viking GmbH | Industriestr. 10/12 | D-23840 Bad Oldesloe | www.viking-emea.com





Industrial detectors

UniVario – Versatile in application

Overview accessories UniVario Heat detectors

Heat detectors						
	Base M16 & M20	Base M16 & M20 Ex	Base* M20 x 1,5 NG Ex	Base NPT*	BaseLCD	Base+ Isolator
WMX5000 (+Single hole)	✓	✗	✓	✓	✓	✓
WMX5000 3GD (+Single hole)	✗	✓	✓	✓	✗	✗
WMX5000 Ex (+Single hole)	✗	✓	✓	✓	✗	✗
WMX5000 FS (+Flex)	✓	✗	✓	✗	✓	✓
WMX5000 FS 3GD (+Flex)	✗	✓	✓	✓	✗	✗
WMX5000 FS Ex (+Flex)	✗	✓	✓	✓	✗	✗

* Cable gland is not included in delivery

Heat detectors								
	Bracket	Console W	Relay module	Comms. module	Relay module 3GD	Comms.-module Ex	Service device	Ex barrier
WMX5000 (+Einloch)	✓	✓	✓	✓	✗	✗	✓	✗
WMX5000 3GD (+Einloch)	✓	✓	✗	✓	✓	✗	✓ ^{*1}	✗
WMX5000 Ex (+Einloch)	✓	✓	✗	✗	✗	✓	✗	✓
WMX5000 FS (+Flex)	✓	✓	✓	✓	✗	✗	✓	✗
WMX5000 FS 3GD (+Flex)	✓	✓	✗	✓	✓	✗	✓ ^{*1}	✗
WMX5000 FS Ex (+Flex)	✓	✓	✗	✗	✗	✓	✗	✓

*1) The service device must not be used in explosion hazardous zones.

312-010_001 / A 08 / 2020-Nov-09 / en
The contents of this publication are subject to modifications without notice. All rights reserved.

Trusted above all.

Viking GmbH | Industriestr. 10/12 | D-23840 Bad Oldesloe | www.viking-emea.com





Industrial detectors

UniVario – Versatile in application

System UniVario YMX5000

The UniVario YMX5000 industrial fire detector consists of a control unit and up to three remote sensor units for fast flame detection. The sensor units are connected to the control unit via cables and thus can be installed even in very cramped spaces. The UniVario YMX5000 monitors vital internal functions itself, cyclically checks its optics for possible contamination or damage and is ideally suited for operation in a tough industrial environment - at temperature ranges from -40 °C up to 80 °C. The industrial fire detector meets individual requirements within a wide range of applications.

YMX5000	Standard	Ex	Accessories
Control units	 YMX5000	 YMX5000 3GD	 Bracket MX5000  Pipe / Wall mounting bracket MX5000
Sensor unit flame detectors	 YMX5000 FMX	 YMX5000 FMX Ex	 Mounting angle YMX5000  Installation kit / Installation kit AF YMX5000  Replaceable optics OS

The sensor units "Ex" can be used with the ignition protection type "flameproof enclosure" and/or "protection by enclosure" in the Ex Zones 1, 2, 20, 21 and 22. The control unit "3GD" with the "non-sparking" ignition protection type and/or "protection by enclosure" may be used in Zone 2 and 22. Thus, no safety barrier and no intrinsic safety certificate are required for connection to the fire detection and suppression control panel.

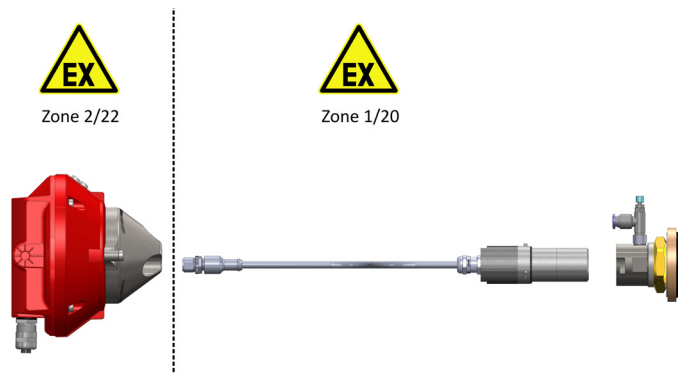

312-010_002 / A102 / 2021-May-10 / en
The contents of this publication are subject to modifications without notice. All rights reserved.

Trusted above all.

Viking GmbH | Industriestr. 10/12 | D-23840 Bad Oldesloe | www.viking-emea.com





Industrial detectors

UniVario – Versatile in application

Overview accessories UniVario YMX5000 - Control units

Accessories Control units	Base M16 & M20	Base M16 & M20 Ex	Base M20 & M20 Ex	Base M20 LCD	Base+ M20	Base+ M20 LCD	Base ST	Base+ Isolator	Base ST
Control unit YMX5000	✓	✗	✓	✓	✗	✓	✗	✗	✗
Control unit YMX5000 3GD	✗	✓	✓	✓	✗	✗	✗	✗	✗
Control unit YMX5000 3GD * Cable gland is not included in delivery	✗	✗	✓	✓	✓	✗	✗	✗	✗

Accessories Control units	Relay module	Terminal module	Terminal mod. Ex	Device	Ex barrier	Locking unit	Bracket	Pipe / Wall mounting bracket
Control unit YMX5000	✓	✗	✗	✗	✗	✗	✓	✓
Control unit YMX5000 3GD	✗	✗	✗	✗	✗	✗	✓	✓
Sensor unit FMX	✓	✓	✓	✓	✓	✓	✓	✓
Sensor unit FMX Ex	✓	✓	✓	✓	✓	✓	✓	✓



Industrial detectors

Optical detection - UniVario IR flame detector

FMX5000 IR



Part no.: 907481

Triple IR flame detector for the detection of typical fires. Including 3 channel optic test monitoring all functional characteristics of detector. Designed for use in rough industrial environments. Equipped for operation as a conventional detector. Expansion to a detector with Loop AP protocol via KMX5000 AP communication module. New uniform optics.

Technical specifications

Detection method	3 IR Sensors
Sensitivity class	adjustable x (50 m (164 ft)) 1, 2, 3
Viewing angle	90°
Operating voltage	7.6 V - 30 V DC
Quiescent current	2.3 mA
Alarm current	approx. 15 mA
Alarm indication	1 red LED
Normal operation indication	1 green LED, flashing
Fault indication current	approx. 15 mA
Fault indication	1 yellow LED
Operating temperature	-40 °C to +80 °C (-40 °F to +176 °F)
IP rating (EN 60529)	IP 66/67
Enclosure material	Diecast aluminum
Relative humidity	max. 95% no condensation
Specification according to	EN 54 Part 10
Weight	820 g (1.8 lbs)
Dimensions	100 x 50 mm (dia. x H) 3.9 x 2 inch (dia. x H)

Product features

- High degree of immunity against false alarms, e.g. from hot surfaces or sunlight
- A microcontroller monitors the functionality and analyses the recorded data. Faults can be indicated on the detector or on a separate line
- Service interface, history memory
- Connection of remote indicator possible
- 3-channel optic test

Optional accessories

Remote indicator LMX5000	908499
Weather protection MX5000 complete	910134
Relay module KMX5000 RK	906361
KMX5000 AP communication module	905883

Not included in delivery

UniVario Base	
Bracket MX5000	904757
Bracket MX5000 SF	914234
Terminating resistor 1.8 K / 0.5 W	675235

Connection / mounting

Connection cable standard detector	2-wire
Additional fault line connection	2-wire
External indication	2-wire
Recommended cable	JY (St) Y 2x2x0.8 mm (0.03 inch)
Conductor cross-section	max. 2.5 mm ² (AWG 13)

Brand	Designation	Order no.	Approvals / marking
Minimax	FMX5000 IR MX	922838	
	FMX5000 IR MX SF (silicone-free)	922814	
Viking	FMX5000 IR VK	922819	
	FMX5000 IR VK SF (silicone-free)	923356	



Industrial detectors

Optical detection - UniVario IR flame detector

FMX5000 IR HR



Part no.: 909404

Triple IR flame detector for the detection of typical fires. Including 3 channel optic test monitoring all functional characteristics of detector. Variant HR (high resistance) designed for use in highly rough industrial environments such as chemical industry. Designed for operation as a conventional detector. Expansion to a detector with Loop AP protocol via KMX5000 AP communication module.

Technical specifications

Detection method	3 IR Sensors
Sensitivity class	adjustable x (50 m (164 ft)) 1, 2, 3
Viewing angle	90°
Operating voltage	7.6 V - 30 V DC
Quiescent current	2.3 mA
Alarm current	approx. 15 mA
Alarm indication	1 red LED
Normal operation indication	1 green LED, flashing
Fault indication current	approx. 15 mA
Fault indication	1 yellow LED
Operating temperature	-40 °C to +80 °C (-40 °F to +176 °F)
IP rating (EN 60529)	IP 66/67
Enclosure material	Diecast aluminum
Relative humidity	max. 95% no condensation
Specification according to	EN 54 Part 10
Weight	820 g (1.8 lbs)
Dimensions	100 x 50 mm (dia. x H) 3.9 x 2 inch (dia. x H)

Product features

- High degree of immunity against false alarms, e.g. from hot surfaces or sunlight
- A microcontroller monitors the functionality and analyses the recorded data. Faults can be indicated on the detector or on a separate line
- Service interface, history memory
- Connection of remote indicator possible
- 3-channel optic test
- Use in atmospheres containing sulphur and hydrochloric acid

Optional accessories

Remote indicator LMX5000	908499
Weather protection MX5000 complete	910134
KMX5000 AP communication module	905883
Relay module KMX5000 RK	906361

Not included in delivery

Base UniVario MX5000 HR	926554
Bracket MX5000 HR	909359
Terminating resistor 1.8 K / 0.5 W	675235

Connection / mounting

Connection cable standard detector	2-wire
Additional fault line connection	2-wire
External indication	2-wire
Recommended cable	JY (St) Y 2x2x0.8 mm (0.03 inch)

Brand	Designation	Order no.	Approvals / marking
Minimax	FMX5000 IR HR MX	924439	G 209141 0786-CPR-20784
Viking	FMX5000 IR HR VK	924438	G 217027 0786-CPR-20784



Industrial detectors

Optical detection - UniVario IR flame detector, Ex

UniVario FMX5000 IR 3GD



Part no.: 909481

Triple IR flame detector for the detection of typical fires. Including 3 channel optic test monitoring all functionalities of detector. ATEX-approved for category 3, Gas and Dust, suitable for use in Ex zones 2 and 22. The detector must not be connected with a safety barrier and a blue fire alarm cable. Designed for use in rough industrial environments. Equipped for operation as a conventional detector. Expansion to a detector with Loop AP protocol via KMX5000 AP communication module.

New uniform optics.

Technical specifications

Detection method	3 IR Sensors
Sensitivity class	adjustable x (50 m (164 ft)) 1, 2, 3
Viewing angle	90°
Operating voltage	7.6 V - 30 V DC
Quiescent current	2.3 mA
Alarm current	approx. 15 mA
Alarm indication	1 LED red
Fault indication current	approx. 15 mA
Fault indication	1 LED yellow
Operating temperature	-40 °C to +80 °C (-40 °F to +176 °F)
IP rating (EN 60529)	IP 66/67
Enclosure material	Diecast aluminum
Relative humidity	max. 95% no condensation
Specification according to	EN 54 Part 10
Weight	820 g (1.8 lbs)
Dimensions	100 x 50 mm (dia. x H) 3.9 x 2 inch (dia. x H)

Product features

- High degree of immunity against false alarms, e.g. from hot surfaces or sunlight
- A microcontroller monitors the functionality and analyses the recorded data. Faults can be indicated on the detector or on a separate line
- Service interface, history memory
- Connection of remote indicator possible
- 3-channel optic test
- For use in Ex zones 2 and 22, ATEX category 3 Gas/Dust

Optional accessories

Parallel indicator LMX5000	908499
KMX5000 AP communication module	905883
Weather protection MX5000 complete	910134
Relay module KMX5000 RK 3GD	925999

Not included in delivery

UniVario base	
Bracket MX5000	904757
Bracket MX5000 SF	914234
Terminating resistor 1.8 K / 0.5 W	675235

Approvals / marking

Type examination certificate (Minimax): BVS 11 ATEX E135
 Type examination certificate (Viking): BVS 17 ATEX E003
 Ex conformity Russia in acc. with TP TC 012/2011 (Minimax)
 Ex approval in acc. with NEC 500/505

Connection / mounting

Connection cable standard detector	2-wire
Additional fault line connection	2-wire
External indication	2-wire
Recommended cable	JY (St) Y 2x2x0.8 mm (0.03 inch)
Conductor cross-section	max. 2.5 mm ² (AWG 13)

Brand	Designation	Order no.	Approvals / marking
Minimax	FMX5000 IR 3GD MX	924418	
	FMX5000 IR 3GD MX SF (silicone-free)	924419	
Viking	FMX5000 IR 3GD VK	924420	
	FMX5000 IR 3GD VK SF (silicone-free)	924421	



Industrial detectors

Optical detection - UniVario IR flame detector, Ex

FMX5000 IR Ex



Product features

- High degree of immunity against false alarms, e.g. from hot surfaces or sunlight
- A microcontroller monitors the functionality and analyses the recorded data. Faults can be indicated on the detector or on a separate line
- Service interface, history memory
- Connection of remote indicator possible
- 3-channel optic test
- For use in Ex zones 1, 2, 20, 21 and 22, ATEX category 2 Gas/1, 2 Dust

Technical specifications

Detection method	3 IR Sensors
Sensitivity class	adjustable x (50 m (164 ft)) 1, 2, 3
Viewing angle	90°
Operating voltage	7.6 V - 30 V DC
Quiescent current	4.5 mA
Alarm current	approx. 15 mA
Alarm indication	1 LED red
Fault indication current	approx. 15 mA
Fault indication	1 LED yellow
Operating temperature	-40 °C to +80 °C (-40 °F to +176 °F)
IP rating (EN 60529)	IP 66/67
Enclosure material	Diecast aluminum
Relative humidity	max. 95% no condensation
Specification according to	EN 54 Part 10
Weight	860 g (1.9 lbs)
Dimensions	100 x 50 mm (dia. x H) 3.9 x 2 inch (dia. x H)

Part no.: 911674

Triple IR flame detector for the detection of typical fires. Including 3 channel optic test monitoring all functionalities of detector. ATEX and IECEx approved for category 2 Gas and 1, 2 Dust, suitable for use in Ex zones 1, 2, 20, 21 and 22. The detectors must be connected via a safety barrier. Designed for use in tough industrial environments. Equipped for operation as a conventional detector. Extension to a detector with Loop AP protocol via the KMX5000 AP Ex. communication module.

Optional accessories

Safety barrier SBEx-9	933093
Safety barrier IS addressable 24 V	901324
KMX5000 AP Ex communication module	912086
Weather protection MX5000 complete	910134
Silicone-free design	

Not included in delivery

UniVario base	
Bracket MX5000	904757
Terminating resistor 1.8 K / 0.5 W	675235

Connection / mounting

Connection cable standard detector	2-wire
Additional fault line connection	2-wire
External indication	2-wire
Recommended cable	JE-Y (St) Y 2x2x0.8 mm (0.03 inch)
Conductor cross-section	max. 2.5 mm ² (AWG 13)

Approvals / marking

Type examination certificate: BVS 12 ATEX E088
IECEx conformity: IECEx BVS 12.0056
Ex approval in acc. with NEC 500/505



G 209141



0786-CPR-20784





Industrial detectors

Optical detection - UniVario UV flame detector

FMX5000 UV



Product features

- High degree of immunity against false alarms, such as storm, lightning or strong sunlight
- A microcontroller monitors the functionality and analyses the recorded data. Faults can be indicated on the detector or on a separate line
- Service interface, history memory
- Connection of remote indicator possible

Technical specifications

Detection method	UV sensor
Sensitivity class	1
Viewing angle	90 °
Operating voltage	7.6 V - 30 V DC
Quiescent current	approx. 0.25 mA
Alarm current	approx. 15 mA
Alarm indication	1 red LED
Normal operation indication	1 green LED, flashing
Fault indication current	approx. 15 mA
Fault indication	1 yellow LED
Operating temperature	-40 °C to +80 °C (-40 °F to +176 °F)
IP rating (EN 60529)	IP 66/67
Enclosure material	Diecast aluminum
Relative humidity	max. 95% no condensation
Specification according to	EN 54-10
Weight	820 g (1.8 lbs)
Dimensions	100 x 50 mm (dia.xH) 3.9 x 2 inch (dia.xH)

Part no.: 904702

UV flame detector for the detection of typical fires. Including UV optic test monitoring all functional characteristics of detector. Designed for use in rough industrial environments and for operation as a conventional detector. Expansion to a detector with Loop AP protocol via KMX5000 AP communication module.

Optional accessories

Remote indicator	908499
Weather protection MX5000 complete	910134
KMX5000 AP communication module	905883
Relay module KMX5000 RK	906361

Not included in delivery

UniVario base	
Bracket MX5000	904757
Bracket MX5000 SF	914234
Terminating resistor 1.8 K / 0.5 W	675235

Spare part

Basket guard	904284
--------------	--------

Connection / mounting

Connection cable standard detector	2-wire
Additional fault line connection	2-wire
External indication	2-wire
Recommended cable	JY (St) Y 2x2x0.8 mm (0.03 inch)
Conductor cross-section	max. 2.5 mm ² (AWG 13)

Brand	Designation	Order no.	Approvals / marking
Minimax	FMX5000 UV MX	926628	
	FMX5000 UV MX SF (silicone-free)	926629	
Viking	FMX5000 UV VK	926630	
	FMX5000 UV VK SF (silicone-free)	926631	



Industrial detectors

Optical detection - UniVario UV flame detector, Ex

FMX5000 UV 3GD

**Part no.: 907267**

UV flame detector for detection of typical fires. Designed for use in harsh industrial environments. Fitted for use as a conventional detector. The FMX5000 UV 3GD UV flame detectors are ATEX approved for Category 3 gas and dust and are intended for use in Ex Zones 2 and 22. Expansion to a detector with Loop AP protocol via the KMX5000 AP communications module. The flame detector features a built-in optical channel function test.

Product features

- High degree of immunity against false alarms, such as storm, lightning or strong sunlight
- Function monitoring and evaluation of measured values by microcontroller, faults can be displayed on the detector or a separate line
- Service interface, history memory
- Connection of external display possible
- Use in Ex Zones 2 and 22 ATEX Category 3 gas/dust

Technical specifications

Detection method	UV-Sensor
Sensitivity class	1
Viewing angle	90°
Operating voltage	7.6 V - 30 V DC
Quiescent current	approx. 0.25 mA
Alarm current	approx. 15 mA
Alarm indication	1 LED red
Fault indication current	approx. 15 mA
Fault indication	1 LED yellow
Operating temperature	-40 °C to +80 °C (-40 °F to +176 °F)
IP rating (EN 60529)	IP 66/67
Enclosure material	Diecast aluminum
Relative humidity	max. 95% no condensation
Specification according to	EN 54 Part 10
Weight	820 g (1.8 lbs)
Dimensions	100 x 50 mm (dia. x H) 3.9 x 2 inch (dia. x H)

Optional accessories

Remote indicator LMX5000	908499
KMX5000 AP communication module	905883
Relay module KMX5000 RK 3GD	925999
Weather protection MX5000 complete	910134

Not included in delivery

UniVario MX5000 base	
Bracket MX5000	904757
Bracket MX5000 SF	914234
Terminating resistor 1,8 K / 0,5 W	675235

Connection / mounting

Connection cable standard detector	2-wire
Additional fault line connection	2-wire
Remote indication	2-wire
Recommended cable	JY (St) Y 2x2x0.8 mm (0.03 inch)
Conductor cross-section	max. 2.5 mm ² (AWG 13)

Approvals / marking

EC type approval certificate (Minimax): BVS 11 ATEX E137
 EC type approval certificate (Viking): BVS 18 ATEX E074
 Ex conformity Russia in acc. with TP TC 012/2011 (Minimax)
 Ex approval in acc. with NEC 500/505

Brand	Designation	Order no.	Approvals / marking
Minimax	FMX5000 UV 3GD MX	929193	G 206132 0786-CPR-20286
	FMX5000 UV 3GD MX SF (silicone-free)	929194	
Viking	FMX5000 UV 3GD VK	929195	G 221017 0786-CPR-20286
	FMX5000 UV 3GD VK SF (silicone-free)	929196	



Industrial detectors

Optical detection - UniVario Flame detectors

Control unit YMX5000



Product features

- Control unit in robust UniVario base enclosure
- 3 sockets to connect up to 3 identical or various sensor units for spark or fast flame detection
- Indication of normal operation, alarm and fault by LED
- History memory
- Independent operation of a fire detection control panel via relay module

Technical specifications

Rated voltage	9 - 24 V DC
Operating voltage	7.6 - 30 V DC
Quiescent current control unit	5 mA
Additionally for each sensor unit	5 mA
Alarm current	approx. 15 mA
Fault indication current	approx. 15 mA
Operating indication	1 green LED, flashing
Fault indication	1 yellow LED, flashing
Alarm indication	1 red LED, flashing
Operating temperature	-40 °C to +80 °C (-40 °F to +176 °F)
Relative humidity	max. 95% no condensation-
IP rating (EN 60529)	IP66 / IP67
Atmospheric pressure	66 - 106.7 kPa
Enclosure material	Diecast aluminum
Weight (incl. base and bracket)	approx. 990 g (2.2 lbs)
Dimensions	92 x 130 x 14 mm (LxWxH) 3.6 x 5.1 x 0.6 inch (LxWxH)
Performance Level acc.to ISO 13849	d *

* The calculation results are restricted to the hardware

Brand	Designation	Order no.	Approvals / markings		
Minimax	YMX5000 MX	930929			
	YMX5000 MX SF ¹⁾	930930			
Viking	YMX5000 VK	930931			
	YMX5000 VK SF ¹⁾	930932			

¹⁾ silicone-free

Part no.: 923452

Control unit of the modular system UniVario YMX5000 for fast flame detection. Designed for use in rough industrial environments. Connection of up to 3 sensor units. Configuration via DIP switches.

Not included in delivery

UniVario base	
Bracket MX5000	904757
Wall mounting bracket MX5000	921984
Pipe mounting bracket MX5000	921978

Accessories

Sensor unit YMX5000 FMX	4003492
-------------------------	---------

Optional accessories

Relay module KMX5000 RK	906361
-------------------------	--------

Connection / mounting

Connection cable standard detector	2-wire
Additional fault line connection	2-wire
Remote indication	2-wire
Recommended cable	J-Y(ST)Y-2x2x0.8 mm
Conductor cross-section	max. 2.5 mm ² (AWG 13)



Industrial detectors

Optical detection - UniVario Flame detectors

Sensor unit YMX5000 FMX



Product features

- Sensor element for fast flame detection
- Cable plug for the connection to the control unit (cable length 1,5 m / 4.92 ft)
- Integrated optical test
- Replaceable optics
- 3 optical input channels

Technical specifications

Measuring principle	3 IR-sensors
Response threshold values in acc. with EN54 - Part 10:	Class 3
Response time	150 - 500 ms
Viewing angle	120 ° (FM) 90 ° (VdS)
Quiescent current	5 mA
Operating temperature Ta: with resting connection cable	-40 °C to +80 °C (-40 °F to +176 °F)
with moving connection cable	-5 °C to +80 °C (23 °F to +176 °F)
with mechanical load of the connection cable	-5 °C to +60 °C (23 °F to +140 °F)
Relative humidity	max. 95% no condensation
IP rating (EN 60529)	IP 66 / IP 67
Enclosure material	Stainless steel
Cable type	AWM Style 2517
Weight	approx. 338 g (0.8 lbs)
Dimensions	30 x 87 mm (ØxL) 1.2 x 3.4 inch (ØxL)
Performance Level acc. to ISO 13849	d *

*The calculation results are restricted to the hardware

Brand	Designation	Order no.	Approvals / marking		
Minimax	YMX5000 FMX MX	4003488			
	YMX5000 FMX MX SF*	4003487			
Viking	YMX5000 FMX VK	4003486			
	YMX5000 FMX VK SF*	4003485			

*silicone-free

Part no.: 4003492

Sensor units for use with Control unit YMX5000, part no. 923452. YMX5000 FMX sensor units have three optical input channels and are designed to detect open flames that can occur during the combustion of materials containing carbon, such as methane, oil products, plastics, and wood. Suitable for areas with restricted installation space.

Accessories

Installation kit YMX5000	916595
Installation kit YMX5000 AF	916518
Single hole mounting tool	843474

Optional accessories

Connecting cable 2 m (6.56 ft)	921039
Connecting cable 5 m (16.40 ft)	923977
Connecting cable 10 m (32.81 ft)	930706
Connecting cable 20 m (65.62)	930707
Wall duct	926036
Cleaning kit optics	916644
Socket YMX5000	923016

Spare parts

Replaceable optics YMX5000 OS	924093
O-ring 26 x 1,5 FKM	919293



Industrial detectors

Optical detection - UniVario Flame detectors, Ex

Control unit YMX5000 3GD















Product features

- Control unit in robust UniVario base enclosure
- 3 sockets to connect up to 3 identical or various sensor units for spark or fast flame detection
- Indication of normal operation, alarm and fault by LED
- History memory
- For use in Ex zones 2 and 22

Technical specifications

Rated voltage	9 - 24 V DC
Operating voltage	7.6 - 30 V DC
Quiescent current control unit	5 mA
Additionally for each sensor unit	5 mA
Alarm current	approx. 15 mA
Fault indication current	approx. 15 mA
Operating indication	1 green LED, flashing
Fault indication	1 yellow LED, flashing
Alarm indication	1 red LED
Operating temperature	-40 °C to +80 °C (-40 °F to +176 °F)
Relative humidity	0 to 95% no condensation-
IP rating (EN 60529)	IP66 / IP67
Atmospheric pressure	66 - 106.7 kPa
Enclosure material	Diecast aluminium
Weight incl. base and bracket	approx. 990 g (2.2 lbs)
Dimensions	92 x 130 x 14 mm (LxWxH) 3.6 x 5.1 x 0.6 inch (LxWxH)
Performance Level acc.to ISO 13849	d *

*The calculation results are restricted to the hardware

Brand	Designation	Order no.	Approvals / markings
Minimax	YMX5000 MX 3GD	930940	     
	YMX5000 MX 3GD SF ¹⁾	930941	
Viking	YMX5000 3GD VK	930942	     
	YMX5000 3GD VK SF ¹⁾	930943	

¹⁾ silicone-free

Part no.: 919561

Control unit of the modular system UniVario YMX5000 for spark or fast flame detection. Designed for use in rough industrial environments. Suitable for use in Ex zones 2 and 22. Connection of up to 3 sensor units. Configuration via DIP switches.

Not included in delivery

UniVario Base	
Bracket MX5000	904757
Wall mounting bracket MX5000	921984
Pipe mounting bracket MX5000	921978

Accessories

Sensor unit YMX5000 FMX Ex	920925
----------------------------	--------

Spare parts

Protection-/ locking unit YMX5000	921147
-----------------------------------	--------

Connection / mounting

Connection cable standard detector	2-wire
Additional fault line connection	2-wire
Remote indication	2-wire
Recommended cable	J-Y(ST)Y-2x2x0.8 mm
Conductor cross-section	max. 2.5 mm ² (AWG 13)

Approvals / marking

Type examination certificate:	
Minimax	BVS 18 ATEX E029
Viking	BVS 19 ATEX E029
IECEX Certificate of conformity:	
Minimax	IECEX BVS 18.0024
Viking	IECEX BVS 19.0030



Industrial detectors

Optical detection - UniVario Flame detectors, Ex

Sensor unit YMX5000 FMX Ex



Product features

- Sensor element for fast flame detection, robust stainless steel
- Cable plug for the connection to the control unit (cable length 1,5 m / 4.92 ft)
- Integrated optical test
- Replaceable optics
- For use in Ex zones 1, 2, 20, 21 and 22
- 3 optical input channels

Technical specifications

Measuring principle	3 IR-sensors
Response threshold values in acc. with EN54 - Part 10	Class 3
Response time	150 - 500 ms
Viewing angle	120 ° (FM) 90 ° (VdS)
Quiescent current	5 mA
Operating temperature Ta: with resting connection cable	-40 °C to + 80 °C (-40 °F to 176 °F)
with moving connection cable	-5 °C to + 80 °C (23 °F to 176 °F)
with mechanical load of the connection cable	-5 °C to + 60 °C (23 °F to 140°F)
Relative humidity	max. 95% no condensation
IP rating (EN 60529)	IP 66 / IP 67
Enclosure material	Stainless steel
Cable type	AWM Style 2517
Weight	approx. 338 g (0.8 lbs)
Dimensions	30 x 87 mm (ØxL) 1.2 x 3.4 inch (ØxL)
Performance Level acc.to ISO 13849	d *

*The calculation results are restricted to the hardware

Brand	Designation	Order no.	Approvals / marking
Minimax	YMX5000 FMX Ex MX	931021	
	YMX5000 FMX Ex MX SF*	931022	
Viking	YMX5000 FMX Ex VK	931023	
	YMX5000 FMX Ex VK SF*	931024	

* silicone-free

Part no.: 920925

Sensor units for use with Control unit YMX5000 3GD, part no. 919561. YMX5000 FMX sensor units have three optical input channels and are designed to detect open flames that can occur during the combustion of materials containing carbon, such as methane, oil products, plastics, and wood. Suitable for areas with restricted installation space. Ignition protection type „flame-proof enclosure“ or „protection by housing“ enables the use in Ex zones 1, 2, 20, 21 and 22.

Accessories

Installation kit YMX5000	916595
Installation kit YMX5000 AF	916518
Single hole mounting tool	843474

Optional accessories

Connecting cable 2 m (6.56 ft)	921039
Connecting cable 5 m (16.40 ft)	923977
Connecting cable 10 m (32.81 ft)	930706
Connecting cable 20 m (65.62 ft)	930707
Protection/ locking unit M12 connect.	920945
Cleaning kit optics	916644
Socket YMX5000	923016

Spare parts

Replaceable optics YMX5000 OS	924093
O-ring 26 x 1,5 FKM	919293

Approvals / marking

Type examination certificate (Minimax): BVS 18 ATEX E029
IECEX Certificate of conformity (Minimax): IECEX BVS 18.0024

Type examination certificate (Viking): BVS 19 ATEX E029
IECEX Certificate of conformity (Viking): IECEX BVS 19.0030



Industrial detectors

UniVario Detector accessories YMX5000

Replaceable optics YMX5000 OS

**Part no.: 924093**

Replaceable optics with abrasion proof window material.
O-Ring 24x1 FKM, part no 916596, is included.

For use with sensor units:

YMX5000 FMX	4003492
YMX5000 FMX Ex	920925

Optionally (single hole mounting <180 °C)

YMX5000 FUX HT	4003480
YMX5000 FUX HT Ex	4000182

Connecting cable

**Part no.: 921039**

2 m (6.56 ft)

Part no.: 923977

5 m (16.4 ft)

Part no.: 930706

10 m (32.8 ft)

Part no.: 930707

20 m (65.6 ft)

Protection / locking unit YMX5000

**Part no.: 921147**

Mechanical protection and locking of the plug-/socket connection to the control unit.

Included in delivery of control unit YMX5000 3GD, part no. 919561.

Protection / locking unit M12 connect.

**Part no.: 920945**

Mechanical protection and locking of the plug-/socket connection to the control unit using the connection cable.
For use in hazardous areas.

End cap YMX5000 SE

**Part no.: 930949**

Light proof cover for the YMX5000 sensor units to protect the optics during maintenance or installation work. The cover cap can be used to check the optical test function by inserting a white paper cutout.

Not included in delivery

Sensor unit



Industrial detectors

UniVario Detector accessories YMX5000

Connector M12 8-pos. panel feed-through



Part no.: 926036

Sensor / actuator-cabinet feedthrough with plug on socket, 8-pos., M12, shielded.
Bipolar / screw mounting with M16 thread.
Not to be used in hazardous areas.

Mounting angle YMX5000

Mounting angle YMX5000 double

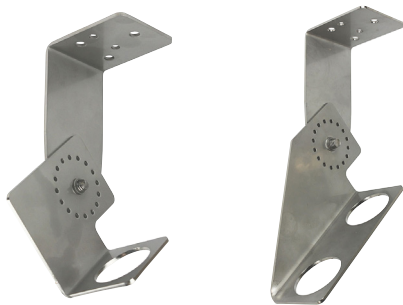

Part no.: 926843

Part no.: 930705

For mounting one/two sensor units YMX5000 with identical viewing angles. The viewing angle of the sensor unit can be adjusted in 22.5° steps. For mounting use installation kit YMX5000, part no. 916595 or installation kit YMX5000 AF, part no. 916518.

Installation kit YMX5000



Part no.: 916595

Single hole mounting is intended for a bore hole measuring 40 mm (+ 1 mm) in diameter. The sensor unit is fixed to the single hole mounting using a bayonet locking mechanism that provides a quick lock solution.

Included in delivery

Sleeve YMX5000
Lock nut M36x1.5

916519
843354



Industrial detectors

UniVario Detector accessories YMX5000

Installation kit YMX5000 AF



Part no.: 916518

Single hole mounting is intended for a bore hole measuring 40 mm (+ 1 mm) in diameter. The sensor unit is fixed to the single hole mounting using a bayonet locking mechanism that provides a quick lock solution. With air flushing. The mounting set YMX5000 AF can be supplied with air continuously or pulsed.

Technical specifications (air flushing)

Operating pressure	0.2 - 10 bar (2.9 - 145 psi)
Standard nominal flow rate	0 - 110 l/min (0 - 30.38 gal/min)
Compressed air hose	Ø 6 mm in QS-Plug connection

Equipotential bonding lug YMX5000



Part no.: 932002

The YMX5000 equipotential bonding lug can be used to establish equipotential bonding at insulating mounting locations of the YMX5000 (LSP) mounting set. The cable lug is designed for 4 - 6 mm² (AWG 12 - AWG 10) connection cable.

Included in delivery

Equipotential bonding lug
Cable lug
Mounting material



Industrial detectors

Thermal detection - UniVario Heat detectors

WMX5000

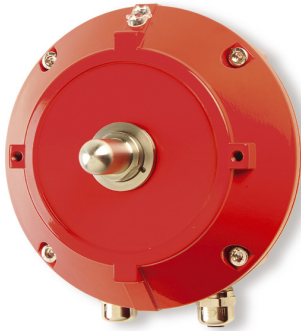

Product features

- Robust stainless steel heat sensor, resistant against impact and vibration
- Freely configurable response temperatures and categories in accordance with EN 54-5, along with rate-of-rise and static responses. Configuration via DIP switches on the detector
- Service interface, history memory
- Connection of remote indicator possible

Technical specifications

Detection method	NTC sensor
Response categories	A1, A2, B, C, indices S, R
Response temperatures	0 °C to +90 °C (+32 °F to +194 °F)
Operating voltage	7.6 V - 30 V DC
Quiescent current	approx. 0.15 mA
Alarm current consumption	approx. 15 mA
Alarm indication	1 red LED
Normal operation indication	1 green LED, flashing
Fault indication current	approx. 15 mA
Fault indication	1 yellow LED (2nd line)
Operating temperature	-40 °C to +80 °C (-40 °F to +176 °F)
IP rating (EN 60529)	IP 67
Enclosure material	Diecast aluminum
Relative humidity	max. 95% no condensation
Specification according to	EN 54-5
Weight	520 g (1.2 lbs)
Dimensions	130 x 84 mm (dia.xH) 5.1 x 3.3 inch (dia.xH)

Part no.: 905441

The WMX5000 heat detectors are designed to detect open fires with rapid rise of temperature, e.g.:

- Flammable liquids and gases
- Highly flammable plastics

They are designed specifically for operation in polluted industrial environments, both indoors and outdoors. In addition to static temperature detection, rapid rises in temperature can also be registered by the rate-of-rise method, for early fire detection. Designed for operation as a conventional detector. Expansion to a detector with Loop AP protocol via KMX5000 AP communication module.

Optional accessories

Remote indicator	908499
Weather protection MX5000 complete	910134
KMX5000 AP communication module	905883
Relay module KMX5000 RK	906361

Not included in delivery

UniVario base	
Bracket MX5000	904757
Bracket MX5000 SF	914234
Terminating resistor 1.8 K / 0.5 W	675235

Connection / mounting

Connection cable standard detector	2-wire
Additional fault line connection	2-wire
Remote indication	2-wire
Recommended cable	JY (St) Y 2x2x0.8 mm (0.03 inch)
Conductor cross-section	max. 2.5 mm ² (AWG 13)

Brand	Designation	Order no.	Approvals / marking				
Minimax	WMX5000 MX	928309					
	WMX5000 MX SF (silicone-free)	928310					
Viking	WMX5000 VK	928311					
	WMX5000 VK SF (silicone-free)	928312					



Industrial detectors

Thermal detection - UniVario Heat detectors

WMX5000 CN

Version China

Technical specifications see part no. 905441

Part no.: 909375

Approvals / marking





Industrial detectors

Thermal detection - UniVario Heat detectors

UniVario WMX5000 single hole



Part no.: 905847

The single hole mounted WMX5000 heat detectors are specifically designed for use in dryer and ventilation ducts for the detection of fires with rapid rise in temperature, e.g.:

- Flammable liquids and gases
- Highly flammable plastics

In addition to fixed temperature detection, rapid rises in temperature can also be registered by the rate-of-rise method, for early fire detection. Designed for operation as a conventional detector. Expansion to a detector with Loop AP protocol via KMX5000 AP communication module.

Technical specifications

Detection method	NTC sensor
Response categories	A1, A2, B, C, D indices S, R
Response temperatures	0 °C to +105 °C (+32 °F to +221 °F)
Operating voltage	7.6 V - 30 V DC
Quiescent current	approx. 0.15 mA
Alarm current consumption	approx. 15 mA
Alarm indication	1 red LED
Normal operation indication	1 green LED, flashing
Fault indication current	approx. 15 mA
Fault indication	1 yellow LED (2nd line)
Operating temperature	-40 °C to +80 °C (-40 °F to +176 °F)
IP rating (EN 60529)	IP 66/67
Enclosure material	Diecast aluminum
Relative humidity	max. 95% no condensation
Specification according to	EN 54-5
Weight	580 g (1.3 lbs)
Dimensions	130 x 133 mm (dia. x H) 5.1 x 5.2 inch (dia. x H)

Product features

- Robust stainless steel heat sensor, resistant to impact and vibration
- Freely configurable response temperatures and categories in accordance with EN 54-5, along with rate-of-rise and static responses. Configuration via DIP switches on the detector
- Service interface, history memory
- Connection of remote indicator possible

Optional accessories

Remote indicator	908499
Weather protection MX5000 complete	910134
KMX5000 AP communication module	905883
Relay module KMX5000 RK	906361
Silicone-free design	

Not included in delivery

UniVario base	
Single hole mounting fixture	800034
Single hole mounting tool	843474
Terminating resistor 1.8 K / 0.5 W	675235

Connection / mounting

Connection cable standard detector	2-wire
Additional fault line connection	2-wire
Remote indication	2-wire
Recommended cable	JY (St) Y 2x2x0.8 mm (0.03 inch)
Conductor cross-section	max. 2.5 mm ² (AWG 13)

Brand	Designation	Order no.	Approvals / marking
Minimax	WMX5000 single hole MX	928371	
	WMX5000 single hole MX SF (silicone-free)	928372	
Viking	WMX5000 single hole VK	928373	
	WMX5000 single hole VK SF (silicone-free)	928374	



Industrial detectors

Thermal detection - UniVario Heat detectors

WMX5000 single hole CN

Version China

Technical specification see part no. 905847

Part no.: 909376

Approvals / marking





Industrial detectors

Thermal detection - UniVario Heat detectors, Ex

WMX5000 3GD



Product features

- Robust stainless steel heat sensor
- Freely configurable response temperatures and categories in accordance with EN 54-5, along with rate-of-rise and static responses. Setting via DIP switches on the detector or SMX5000 service device
- Service interface, history memory
- Connection of remote indicator possible
- For use in Ex zones 2 and 22, ATEX category 3 Gas/Dust

Technical specifications

Detection method	NTC sensor
Response categories	A1, A2, B, C, indices S, R
Response temperatures	0 °C to +90 °C (+32 °F to +194 °F)
Operating voltage	7.6 V - 30 V DC
Quiescent current	approx. 0.15 mA
Alarm current consumption (without quiescent current)	approx. 15 mA
Alarm indication	1 red LED
Normal operation indication	1 green LED, flashing
Fault indication current	approx. 15 mA
Fault indication	1 yellow LED (2nd line)
Operating temperature	-40 °C to +80 °C (-40 °F to +176 °F)
IP rating (EN 60529)	IP 66/67
Enclosure material	Diecast aluminum
Relative humidity	max. 95% no condensation
Specification according to	EN 54-5
Weight	520 g (1.2 lbs)
Dimensions	130 x 84 mm (dia.xH) 5.1 x 3.3 inch (dia.xH)

Part no.: 907268

The WMX5000 3GD heat detectors are ATEX-approved for category 3, gas and dust, and are suitable for use in Ex zones 2 and 22. They are designed to detect open fires with rapid rise of temperature, e.g.:

- Flammable liquids and gases
- Highly flammable plastics

They are designed specifically for operation in dirty industrial environments, both indoors and outdoors. In addition to stated temperature detection, rapid rises in temperature can also be registered by the rate-of-rise method, for early fire detection. Equipped for operation as a conventional detector. Extension to a detector with Loop AP protocol via the KMX5000 AP communication module.

Optional accessories

Remote indicator	908499
KMX5000 AP communication module	905883
Relay module KMX5000 RK 3GD	925999

Not included in delivery

UniVario base	
Bracket MX5000	904757
Bracket MX5000	914234
Terminating resistor 1.8 K / 0.5 W	675235

Connection / mounting

Connection cable standard detector	2-wire
Additional fault line connection	2-wire
Remote indication	2-wire
Recommended cable	JY (St) Y 2x2x0.8 mm (0.03 inch)
Conductor cross-section	max. 2.5 mm ² (AWG 13)

Approvals / marking

Type examination certificate (Minimax): BVS 07 ATEX E 156
 Type examination certificate (Viking): BVS 18 ATEX E 075
 Ex conformity Russia in acc. with TP TC 012/2011 (Minimax)
 Ex approval in acc. with NEC 500/505

Brand	Designation	Order no.	Approvals / marking
Minimax	WMX5000 3GD MX	928444	
	WMX5000 3GD MX SF (silicone-free)	928445	
Viking	WMX5000 3GD VK	928446	
	WMX5000 3GD VK SF (silicone-free)	928447	



Industrial detectors

Thermal detection - UniVario Heat detectors, Ex

WMX5000 3GD single hole



Product features

- Robust stainless steel heat sensor, resistant against impact and vibration
- Freely configurable response temperatures and categories in accordance with EN 54-5, along with rate-of-rise and static responses. Configuration via DIP switches on the detector or SMX5000 service device
- Service interface, history memory
- Connection of remote indicator possible
- For use in Ex zones 2 and 22, ATEX category 3, Gas/Dust

Technical specifications

Detection method	NTC sensor
Response categories	A1, A2, B, C, D, indices S, R
Response temperatures	0 °C to +105 °C (+32 °F to +221 °F)
Operating voltage	7.6 V - 30 V DC
Quiescent current	approx. 0.15 mA
Alarm current consumption (without quiescent current)	approx. 15 mA
Alarm indication	1 red LED
Normal operation indication	1 green LED, flashing
Fault indication current	approx. 15 mA
Fault indication	1 yellow LED (2nd line)
Operating temperature	-40 °C to +80 °C (-40 °F to +176 °F)
IP rating (EN 60529)	IP 66/67
Enclosure material	Diecast aluminum (saltwater-proof)
Relative humidity	max. 95%, no condensation
Specification according to	EN 54-5
Weight	580 g (1.3 lbs)
Dimensions	130 x 133 mm (dia. x H) 5.1 x 5.2 inch (dia. x H)

Part no.: 907269

The single hole mounted WMX5000 3GD heat detectors are ATEX-approved for category 3, gas and dust, and are suitable for use in Ex zones 2 and 22. They are specifically suited for use in dryer and ventilation ducts for the detection of fires with rapid rise in temperature, e.g.:

- Flammable liquids and gases
- Highly flammable plastics

In addition to stated temperature detection, rapid rises in temperature can also be registered by the rate-of-rise method, for early fire detection. Equipped for operation as a conventional detector. Extension to a detector with Loop AP protocol via the KMX5000 AP communication module.

Optional accessories

Remote indicator	908499
KMX5000 AP communication module	905883
Relay module KMX5000 RK 3GD	925999
Weather protection MX5000 complete	910134

Not included in delivery

UniVario base	
Single hole mounting fixture	800034
Single hole mounting tool	843474
Terminating resistor 1.8 K / 0.5 W	675235

Connection / mounting

Connection cable standard detector	2-wire
Additional fault line connection	2-wire
Remote indication	2-wire
Recommended cable	JY (St) Y 2x2x0.8 mm (0.03 inch)
Line cross-section	max. 2.5 mm ² (AWG 13)

Approvals / marking

Type examination certificate: BVS 07 ATEX E 156
Ex approval in acc. with NEC 500/505

Brand	Designation	Order no.	Approvals / marking
Minimax	WMX5000 3GD single hole MX	928388	G 207090 0786-CPR-20280
	WMX5000 3GD single hole MX SF (silicone-free)	928385	
Viking	WMX5000 3GD single hole VK	928386	G 221018 0786-CPR-21766
	WMX5000 3GD single hole VK SF (silicone-free)	928387	



Industrial detectors

Thermal detection - UniVario Heat detectors, Ex

WMX5000 Ex



Product features

- Robust stainless steel heat sensor
- Freely configurable response temperatures and categories in accordance with EN 54-5, along with rate-of-rise and static responses. Setting via DIP switches on the detector or SMX5000 service device
- Service interface, history memory
- Connection of remote indicator possible
- For use in Ex zones 1, 2, 20, 21 and 22, ATEX category 2 Gas/1, 2 Dust

Technical specifications

Detection method	NTC sensor
Response categories	A1, A2, B, C, indices S, R
Response temperatures	0 °C to +90 °C (+32 °F to +194 °F)
Operating voltage	7.6 V - 30 V DC
Quiescent current	approx. 2.8 mA
Alarm current consumption (without quiescent current)	approx. 15 mA
Alarm indication	1 red LED
Normal operation indication	1 green LED, flashing
Fault indication current	approx. 15 mA
Fault indication	1 yellow LED (2nd line)
Operating temperature	-40 °C to +80 °C (-40 °F to +176 °F)
IP rating (EN 60529)	IP 66/67
Enclosure material	Diecast aluminum
Relative humidity	max. 95% no condensation
Specification according to	EN 54-5
Weight	520 g (1.2 lbs)
Dimensions	130 x 84 mm (dia. x H) 5.1 x 3.3 inch (dia. x H)

Part no.: 912117

The WMX5000 Ex heat detectors are ATEX and IECEx approved for category 2 gas and 1, 2 dust, and are suitable for use in Ex zones 1, 2, 20, 21 and 22. They are designed to detect open fires with rapid rise of temperature, e.g.:

- Flammable liquids and gases
- Highly flammable plastics

They are designed specifically for operation in dirty industrial environments, both indoors and outdoors. In addition to stated temperature detection, rapid rises in temperature can also be registered by the rate-of-rise method, for early fire detection. Equipped for operation as a conventional detector. Extension to a detector with Loop AP protocol via the KMX5000 AP Ex communication module.

Optional accessories

Safety barrier SBEx-9	933093
Safety barrier IS addressable 24 V	901324
KMX5000 AP Ex communication module	912086
Weather protection MX5000 complete	910134
Silicone-free design	

Not included in delivery

UniVario base	
Bracket MX5000	904757
Terminating resistor 1.8 K / 0.5 W	675235

Connection / mounting

Connection cable standard detector	2-wire
Additional fault line connection	2-wire
Remote indication	2-wire
Recommended cable	JE-Y (St) Y 2x2x0.8 mm (0.03 inch)
Conductor cross-section	max. 2.5 mm ² (AWG 14)

Approvals / marking

Type examination certificate:	BVS 12 ATEX E121
IECEx conformity:	IECEx BVS 12.0074
Ex approval in acc. with NEC 500/505	



G 207090



0786-CPR-20280





Industrial detectors

Thermal detection - UniVario Heat detectors, Ex

WMX5000 Ex single hole



Product features

- Robust stainless steel heat sensor, resistant against impact and vibration
- Freely configurable response temperatures and categories in accordance with EN 54-5, along with rate-of-rise and static responses. Configuration via DIP switches on the detector or SMX5000 service device
- Service interface, history memory
- Connection of remote indicator possible
- For use in Ex zones 1, 2, 20, 21 and 22, ATEX category 2, Gas/ 1, 2 Dust

Technical specifications

Detection method	NTC sensor
Response categories	A1, A2, B, C, D, indices S, R
Response temperatures	0 °C to +105 °C (+32 °F to +221 °F)
Operating voltage	7.6 V - 28 V DC
Quiescent current	approx. 3.0 mA
Alarm current consumption (without quiescent current)	approx. 15 mA
Alarm indication	1 red LED
Normal operation indication	1 green LED, flashing
Fault indication current	approx. 15 mA
Fault indication	1 yellow LED (2nd line)
Operating temperature	-40 °C to +80 °C (-40 °F to +176 °F)
IP rating (EN 60529)	IP 66/67
Enclosure material	diecast aluminum
Relative humidity	max. 95% no condensation
Specification according to	EN 54-5
Weight	580 g (1.3 lbs)
Dimensions	130 x 133 mm (dia. x H) 5.1 x 5.2 inch (dia. x H)

Part no.: 912118

The single hole mounted WMX5000 Ex heat detectors are ATEX-approved for category 2, gas and 1, 2 dust, and are suitable for use in Ex zones 1, 2, 20, 21 and 22. They are specifically suited for use in dryer and ventilation ducts for the detection of fires with rapid rise in temperature, e.g.:

- Flammable liquids and gases
- Highly flammable plastics

In addition to stated temperature detection, rapid rises in temperature can also be registered by the rate-of-rise method, for early fire detection. Equipped for operation as a conventional detector. Extension to a detector with Loop AP protocol via the KMX5000 AP Ex communication module.

Optional accessories

Safety barrier SBEx-9	933093
Safety barrier IS addressable 24 V	901324
KMX5000 AP Ex communication module	912086
Silicone-free design	

Not included in delivery

UniVario base	
Single hole mounting fixture	800034
Single hole mounting tool	843477
Terminating resistor 1.8 K / 0.5 W	675235

Connection / mounting

Connection cable standard detector	2-wire
Additional fault line connection	2-wire
Remote indication	2-wire
Recommended cable	JE-Y (St) Y 2x2x0.8 mm (0.03 inch)
Line cross-section	max. 2.5 mm ² (AWG 13)

Approvals / marking

Type examination certificate:	BVS 12 ATEX E121
IECEx conformity:	IECEx BVS 12.0074
Ex approval in acc. with NEC 500/505	



G 207090



0786-CPR-20280





Industrial detectors

Thermal detection - UniVario High temperature heat detector FS

WMX5000 FS 400°C (752 °F)



Part no.: 905505

The WMX5000 FS high temperature heat detectors have been specially designed for operation in industrial environments with aggressive media and very high application temperatures in the monitoring area. For example in exhaust ducts, engine test stands or machine tools. In addition to fixed temperature detection, rapid rises in temperature can also be registered by the rate-of-rise method, for early fire detection. Designed for operation as a conventional detector. Expansion to a detector with Loop AP protocol via KMX5000 AP communication module.

Product features

- Robust stainless steel heat rod sensor
- Freely configurable response temperatures and categories in accordance with EN 54-5, along with rate-of-rise and static responses. Configuration via DIP switches on the detector
- Service interface, history memory
- Connection of remote indicator possible

Technical specifications

Detection method	PT1000 sensor
Response categories	A1, A2, B, C, D, E, F, G, indices S, R
Response temperatures	0 °C to +400 °C (+32 °F to +752 °F)
Operating voltage	7.6 V - 30 V DC
Quiescent current	approx. 0.25 mA
Alarm current consumption	approx. 15 mA
Alarm indication	1 red LED
Normal operation indication	1 green LED, flashing
Fault indication current	approx. 15 mA
Fault indication	1 yellow LED (2nd line)
Operating temperature	-40 °C to +80 °C (-40 °F to +176 °F)
IP rating (EN 60529)	IP 66/67
Enclosure material	Diecast aluminum
Relative humidity	max. 95% no condensation
Specification according to	EN 54-5
Sensor rod	150 - 1500 mm 5.1 - 59.1 inch (dia.xH)
Weight	520 - 1600 g (1.2 - 3.5 lbs)
Dimensions	130 x 210 - 130 x 1560 mm 5.1 x 83 - 5.1 x 61.4 inch (dia.xH)

Optional accessories

Remote indicator	908499
KMX5000 AP communication module	905883
Relay module KMX5000 RK	906361
Silicone-free design	

Not included in delivery

UniVario base	
Single hole mounting fixture	800034
Single hole mounting tool	843474
Terminating resistor 1.8 K / 0.5 W	675235

Connection / mounting

Connection cable standard detector	2-wire
Additional fault line connection	2-wire
Remote indication	2-wire
Recommended cable	JY (St) Y 2x2x0.8 mm (0.03 inch)
Conductor cross-section	max. 2.5 mm ² (AWG 13)







Note

Deviating from the defined standard lengths, the sensor rod can be ordered in lengths of 150 - 1500 mm, see ordering table page 2/2.



Industrial detectors

Thermal detection - UniVario High temperature heat detector FS

Brand	Designation	Sensor rod** (mm)	Order no.	Approvals / markings
Minimax	WMX5000 FS L200 MX	200	906401	   
	WMX5000 FS L200 MX SF*		927683	
	WMX5000 FS L400 MX	400	906402	
	WMX5000 FS L400 MX SF*		927700	
	WMX5000 FS L600 MX	600	906403	
	WMX5000 FS L600 MX SF*		927709	
Viking	WMX5000 FS L200 VK	200	927684	  
	WMX5000 FS L200 VK SF*		927685	
	WMX5000 FS L400 VK	400	927701	
	WMX5000 FS L400 VK SF*		927702	
	WMX5000 FS L600 VK	600	927710	
	WMX5000 FS L600 VK SF*		927711	

* silicone-free

** Variable length 150 - 1500 mm available for order. The length of the sensor rod must be specified in mm when ordering.



Industrial detectors

Thermal detection - UniVario High temperature heat detector FS

WMX5000 FS 850°C (1562 °F)



Part no.: 906454

The WMX5000 FS high temperature heat detectors have been specially designed for operation in industrial environments with aggressive media and very high application temperatures in the monitoring area. For example in exhaust ducts, engine test stands or machine tools. In addition to fixed temperature detection, rapid rises in temperature can also be registered by the rate-of-rise method, for early fire detection. Designed for operation as a conventional detector. Expansion to a detector with Loop AP protocol via KMX5000 AP communication module.

Product features

- Robust stainless steel heat rod sensor
- Freely configurable response temperatures and classes in accordance with EN 54-5, along with rate-of-rise and static responses. Configuration via DIP switches on the detector
- Service interface, history memory
- Connection of remote indicator possible

Technical specifications

Detection method	PT100-sensor
Response classes	A1, A2, B, C, D, E, F, G, indices S, R
Response temperatures	250 °C to +840 °C (+482 °F to +1544 °F)
Operating voltage	7.6 V - 30 V DC
Quiescent current	approx. 0.35 mA
Alarm current consumption	approx. 15 mA
Alarm indication	1 red LED
Normal operation indication	1 green LED, flashing
Fault indication current	approx. 15 mA
Fault indication	1 yellow LED (2nd line)
Operating temperature	-40 °C to +80 °C (-40 °F to +176 °F)
IP rating (EN 60529)	IP 66/67
Enclosure material	Diecast aluminum
Relative humidity	max. 95% no condensation
Specification according to	EN 54 Part 5
Weight	520 - 1600 g (1.2 - 3.5 lbs)
Dimensions	130 x 150 - 130 x 1500 mm (dia. x H) 5.1 x 5.9 x 59.1 inch (dia. x H)

Optional accessories

Remote indicator	908499
KMX5000 AP communication module	905883
Relay module KMX5000 RK	906361
Silicone-free design	

Not included in delivery

UniVario base	
Single hole mounting fixture	800034
Single hole mounting tool	800388
Terminating resistor 1.8 K / 0.5 W	675235

Connection / mounting

Connection cable standard detector	2-wire
Additional fault line connection	2-wire
Remote indication	2-wire
Recommended cable	JY (St) Y 2x2x0.8 mm (0.03 inch)
Conductor cross-section	max. 2.5 mm ² (AWG 13)

Note

The desired length of the sensor rod must be specified in millimeters at the time of placing the order.

Approvals / marking





Industrial detectors

Thermal detection - UniVario High temperature heat detector FS, Ex

WMX5000 FS 3GD 400°C (752 °F)

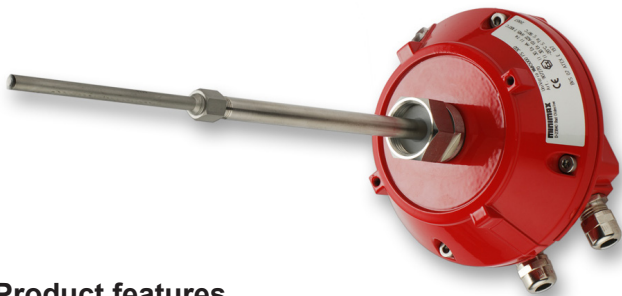

Product features

- Robust stainless steel heat rod sensor
- Freely configurable response temperatures and categories in accordance with EN 54-5, along with rate-of-rise and static responses. Configuration via DIP switches on the detector or SMX5000 service device
- Service interface, history memory
- Connection of remote indicator possible
- For use in Ex zones 2 and 22, Atex category 3, Gas/Dust

Technical specifications

Detection method	PT1000 sensor
Response categories	A1, A2, B, C, D, E, F, G, indices S, R
Response temperatures	0 °C to +400 °C (+32 °F to +752 °F)
Operating voltage	7.6 V - 30 V DC
Quiescent current	approx. 0.25 mA
Alarm current consumption	approx. 15 mA
Alarm indication	1 red LED
Normal operation indication	1 green LED, flashing
Fault indication current	approx. 15 mA
Fault indication	1 yellow LED (2nd line)
Operating temperature	-40 °C to +80 °C (-40 °F to +176 °F)
IP rating (EN 60529)	IP 66/67
Enclosure material	Diecast aluminum
Relative humidity	max. 95% no condensation
Specification according to	EN 54-5
Sensor rod	150 - 1500 mm
Weight	520 - 1600 g (1.2 - 3.5 lbs)
Dimensions	130 x 210 - 130 x 1560 mm (dia.xH) 5.1 x 83 - 5.1 x 61.4 inch (dia.xH)

Part no.: 907270

The WMX5000 FS 3GD high temperature heat detectors are ATEX-approved for category 3, gas and dust, and are suitable for use in Ex zones 2 and 22. They have been specially designed for operation in industrial environments with aggressive media and very high application temperatures in the monitoring area.

For example in exhaust ducts, engine test stands or machine tools. In addition to stated temperature detection, rapid rises in temperature can also be registered by the rate-of-rise method, for early fire detection. Equipped for operation as a conventional detector. Extension to a detector with Loop AP protocol via the KMX5000 AP communication module.

Optional accessories

Remote indicator	908499
KMX5000 AP communication module	905883
Relay module KMX5000 RK 3GD	925999
Silicone-free design	

Not included in delivery

UniVario base	
Single hole mounting fixture	800034
Single hole mounting tool	843474
Terminating resistor 1.8 K / 0.5 W	675235

Connection / mounting

Connection cable standard detector	2-wire
Additional fault line connection	2-wire
Remote indication	2-wire
Recommended cable	JY (St) Y 2x2x0.8 mm (0.03 inch)
Conductor cross-section	max. 2.5 mm ² (AWG 13)

Note

Deviating from the defined standard lengths, the sensor rod can be ordered in lengths of 150 - 1500 mm, see ordering table page 2/2.







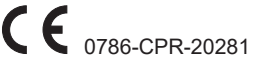

Approvals / marking

Type examination certificate (Minimax): BVS 07 ATEX E 157
Type examination certificate (Viking): BVS 18 ATEX E 076
Ex approval in acc. with NEC 500/505

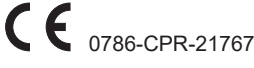

Industrial detectors

Thermal detection - UniVario High temperature heat detector FS, Ex

Brand	Designation	Sensor rod (mm)	Order no.	Approvals / markings
Minimax	WMX5000 FS 3GD L200 MX	200	907281	    
	WMX5000 FS 3GD L200 MX SF*		927744	
	WMX5000 FS 3GD L400 MX	400	907282	
	WMX5000 FS 3GD L400 MX SF*		927747	
	WMX5000 FS 3GD L600 MX	600	907283	
	WMX5000 FS 3GD L600 MX SF*		927751	
Viking	WMX5000 FS 3GD L200 VK	200	927745	    
	WMX5000 FS 3GD L200 VK SF*		927746	
	WMX5000 FS 3GD L400 VK	400	927748	
	WMX5000 FS 3GD L400 VK SF*		927749	
	WMX5000 FS 3GD L600 VK	600	927752	
	WMX5000 FS 3GD L600 VK SF*		927753	

* silicone-free

** Variable length 150 - 1500 mm available for order. The length of the sensor rod must be specified in mm when ordering.



Industrial detectors

Thermal detection - UniVario High temperature heat detector FS, Ex

WMX5000 FS Ex 400°C

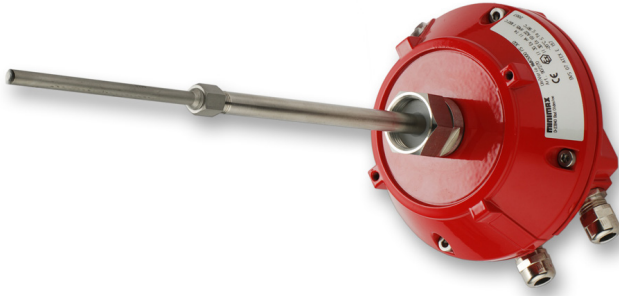

Product features

- Robust stainless steel heat rod sensor
- Freely configurable response temperatures and categories in accordance with EN 54-5, along with rate-of-rise and static responses. Configuration via DIP switches on the detector or SMX5000 service device
- Service interface, history memory
- Connection of remote indicator possible
- For use in Ex zones 1, 2, 20, 21 and 22, Atex category 3 Gas/1, 2 Dust

Technical specifications

Detection method	PT1000 sensor
Response categories	A1, A2, B, C, D, E, F, G, indices S, R
Response temperatures	0 °C to +400 °C (+32 °F to +752 °F)
Operating voltage	7.6 V - 28 V DC
Quiescent current	approx. 2.8 mA
Alarm current consumption	approx. 15 mA
Alarm indication	1 red LED
Normal operation indication	1 green LED, flashing
Fault indication current	approx. 15 mA
Fault indication	1 yellow LED (2nd line)
Operating temperature	-40 °C to +80 °C (-40 °F to +176 °F)
IP rating (EN 60529)	IP 66/67
Enclosure material	Diecast aluminum
Relative humidity	max. 95% no condensation
Specification according to	EN 54-5
Weight	520 to 1600 g (1.2 to 3.5 lbs)
Dimensions	130 x 150 - 130 x 1500 mm (dia. x H) 5.1 x 5.9 - 5.1 x 59.1 inch (dia. x H)

Part no.: 912108

The WMX5000 FS Ex high temperature heat detectors are ATEX- and IEC approved for category 2 gas and 1, 2 dust, and are suitable for use in Ex zones 1, 2, 20, 21 and 22. They have been specially designed for operation in industrial environments with aggressive media and very high application temperatures in the monitoring area. For example in exhaust ducts, engine test stands or machine tools. In addition to stated temperature detection, rapid rises in temperature can also be registered by the rate-of-rise method, for early fire detection. Equipped for operation as a conventional detector. Extension to a detector with Loop AP protocol via the KMX5000 AP Ex communication module.

Optional accessories

Safety barrier SBEx-9	933093
Safety barrier IS addressable 24 V	901324
KMX5000 AP Ex communication module	912086
Silicone-free design	

Not included in delivery

UniVario base	
Single hole mounting fixture	800034
Single hole mounting tool	843474
Terminating resistor 1.8 K / 0.5 W	675235

Connection / mounting

Connection cable standard detector	2-wire
Additional fault line connection	2-wire
Remote indication	2-wire
Recommended cable	JE-Y (St) Y 2x2x0.8 mm (0.03 inch)
Conductor cross-section	max. 2.5 mm ² (AWG 13)

Note

The desired length of the sensor rod must be specified in millimeters at the time of placing the order. Alternatively, fixed standard rod lengths are available to choose from.

Approvals / marking

Type examination certificate:	BVS 12 ATEX E120
IECEx conformity:	IECEx BVS 12.0073
Ex approval in acc. with NEC 500/505	



G 207091



0786-CPR-20281





Industrial detectors

Thermal detection - UniVario High temperature heat detector FS, Ex

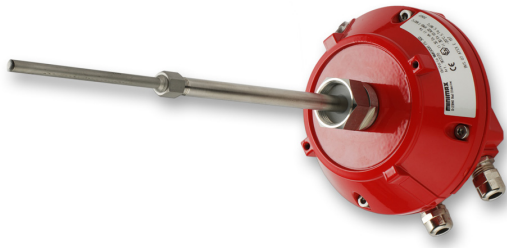

WMX5000 FS Ex 400 °C 200 mm (752 °F 7.9 inch)

Part no.: 912110

With fixed rod length of 200 mm (7.9 inch)

Otherwise like part no.: 912108

Technical specifications

Response temperatures	0 °C to +400 °C (+32 °F to +752 °F)
Weight	680 g (1.5 lbs)
Dimensions	130 x 260 mm (dia. x H) 5.1 x 10.2 inch (dia. x H)

WMX5000 FS Ex 400 °C 400 mm (752 °F 15.8 inch)

Part no.: 912111

With fixed rod length of 400 mm (15.8 inch)

Otherwise like part no.: 912108

Technical specifications

Response temperatures	0 °C to +400 °C (+32 °F to +752 °F)
Weight	840 g (1.9 lbs)
Dimensions	130 x 460 mm (dia. x H) 5.1 x 18.1 inch (dia. x H)

WMX5000 FS Ex 400 °C 600 mm (752 °F 23.6 inch)

Part no.: 912112

With fixed rod length of 600 mm (23.6 inch)

Otherwise like part no.: 912108

Technical specifications

Response temperatures	0 °C to +400 °C (+32 °F to +752 °F)
Weight	1000 g (2.2 lbs)
Dimensions	130 x 660 mm (dia. x H) 5.1 x 26 inch (dia. x H)



Industrial detectors

Thermal detection - UniVario High temperature heat detector FS Flex

WMX5000 FS Flex 400°C (752 °F)



Product features

- Robust flexible stainless steel heat sensor
- Freely configurable response temperatures and categories in accordance with EN 54-5, along with rate-of-rise and static responses. Configuration via DIP switches on the detector
- Service interface, history memory
- Connection of remote indicator possible

Technical specifications

Detection method	PT1000 sensor
Response categories	A1, A2, B, C, D, E, F, G, indices S, R
Response temperatures	0 °C to +400 °C (+32 °F to +752 °F)
Operating voltage	7.6 V - 30 V DC
Quiescent current	approx. 0.25 mA
Alarm current consumption	approx. 15 mA
Alarm indication	1 red LED
Normal operation indication	1 green LED, flashing
Fault indication current	approx. 15 mA
Fault indication	1 yellow LED (2nd line)
Operating temperature	-40 °C to +80 °C (-40 °F to +176 °F)
IP rating (EN 60529)	IP 66/67
Enclosure material	Diecast aluminum
Relative humidity	max. 95% no condensation
Specification according to	EN 54-5
Weight:	
2000 mm	1536 g (3.39 lbs)
6000 mm	2315 g (5.10 lbs)
9000 mm	2665 g (5.88 lbs)
Dimensions	130 x 2000 - 130 x 9000 mm (dia.xH) 5.1 x 78.7 - 5.1 x 354.3 inch (dia.xH)

Part no.: 906176

The WMX5000 FS high temperature heat detectors have been specially designed for operation in industrial environments with aggressive media and very high application temperatures in the monitoring area. For example in exhaust ducts, engine test stands or machine tools. In addition to fixed temperature detection, rapid rises in temperature can also be registered by the rate-of-rise method, for early fire detection. Designed for operation as a conventional detector. Expansion to a detector with Loop AP protocol via KMX5000 AP communication module.

Optional accessories

Remote indicator	908499
KMX5000 AP communication module	905883
Relay module KMX5000 RK	906361
Silicone-free design	

Not included in delivery

UniVario base	
Holder WMX FS, from	
250 °C (482 °F) to 600 °C (1112 °F)	894679
Terminating resistor 1.8 K / 0.5 W	675235

Connection / mounting

Connection cable standard detector	2-wire
Additional fault line connection	2-wire
Remote indication	2-wire
Recommended cable	JY (St) Y 2x2x0.8 mm (0.03 inch)
Conductor cross-section	max. 2.5 mm ² (AWG 13)







Note

Deviating from the defined standard lengths, the flexible sensor rod can be ordered in lengths of 500 to 9000 mm, see ordering table page 2/2. The sensor rod holder is designed for application temperatures of up to 250 °C (482 °F). In case of higher application temperatures, the holder WMX FS from 250 °C (482 °F) to 600 °C (1112 °F), part no. 804679, is to be used.

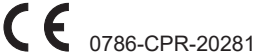

Industrial detectors

Thermal detection - UniVario High temperature heat detector FS Flex

Brand	Designation	flex. Sensor rod** length (mm)	Order no.	Approvals / marking
Minimax	WMX5000 FS Flex L2000 MX	2000	906404	   
	WMX5000 FS Flex L2000 MX SF*		927975	
	WMX5000 FS Flex L6000 MX	6000	906405	
	WMX5000 FS Flex L6000 MX SF*		927978	
	WMX5000 FS Flex L9000 MX	9000	906406	
	WMX5000 FS Flex L9000 MX SF*		927981	
Viking	WMX5000 FS Flex L2000 VK	2000	927976	  
	WMX5000 FS Flex L2000 VK SF*		927977	
	WMX5000 FS Flex L6000 VK	6000	927979	
	WMX5000 FS Flex L6000 VK SF*		927980	
	WMX5000 FS Flex L9000 VK	9000	927982	
	WMX5000 FS Flex L9000 VK SF*		927983	

* silicone-free

** Order from 500 - 9000 mm length possible. Length specification in mm required.



Industrial detectors

Thermal detection - UniVario High temperature heat detector FS Flex

WMX5000 FS Flex 850°C (1562 °F)



Product features

- Robust flexible stainless steel heat sensor
- Freely configurable response temperatures and classes in accordance with EN 54-5, along with rate-of-rise and static responses. Configuration via DIP switches on the detector
- Service interface, history memory
- Connection of remote indicator possible

Technical specifications

Detection method	PT1000 sensor
Response classes	A1, A2, B, C, D, E, F, G, indices S, R
Response temperatures	250 °C to +840 °C (+482 °F to +1544 °F)
Operating voltage	7.6 V - 30 V DC
Quiescent current	approx. 0.35 mA
Alarm current consumption	approx. 15 mA
Alarm indication	1 red LED
Normal operation indication	1 green LED, flashing
Fault indication current	approx. 15 mA
Fault indication	1 yellow LED (2nd line)
Operating temperature	-40 °C to +80 °C (-40 °F to +176 °F)
IP rating (EN 60529)	IP 66/67
Enclosure material	Diecast aluminum
Relative humidity	max. 95% no condensation
Specification according to	EN 54 Part 5
Weight	520 - 1600 g (1.2 - 3.5 lbs)
Dimensions	130 x 2000 - 130 x 9000 mm (dia. x H) 5.1 x 78.7 - 5.1 x 354.3 inch (dia. x H)

Optional accessories

Remote indicator	908499
KMX5000 AP communication module	905883
Relay module KMX5000 RK	906361

Not included in delivery

UniVario base	
Terminating resistor 1.8 K / 0.5 W	675235

Connection / mounting

Connection cable standard detector	2-wire
Additional fault line connection	2-wire
Remote indication	2-wire
Recommended cable	JY (St) Y 2x2x0.8 mm (0.03 inch)
Conductor cross-section	max. 2.5 mm ² (AWG 13)

Note

The desired length of the flexible sensor rod must be specified in meters at the time of placing the order.

Approvals / marking





Industrial detectors

Thermal detection - UniVario High temperature heat detector FS Flex, Ex

WMX5000 FS Flex 3GD 400°C (752 °F)



Product features

- Robust flexible stainless steel heat sensor
- Freely configurable response temperatures and categories in accordance with EN 54-5, along with rate-of-rise and static responses. Configuration via DIP switches on the detector or SMX5000 service device
- Service interface, history memory
- Connection of remote indicator possible
- For use in Ex zones 2 and 22, Atex category 3, Gas/Dust

Technical specifications

Detection method	PT1000 sensor
Response categories	A1, A2, B, C, D, E, F, G, indices S, R
Response temperatures	0 °C to +400 °C (+32 °F to +752 °F)
Operating voltage	7.6 V - 30 V DC
Quiescent current	approx. 0.25 mA
Alarm current consumption	approx. 15 mA
Alarm indication	1 red LED
Normal operation indication	1 green LED, flashing
Fault indication current	approx. 15 mA
Fault indication	1 yellow LED (2nd line)
Operating temperature	-40 °C to +80 °C (-40 °F to +176 °F)
IP rating (EN 60529)	IP 66/67
Enclosure material	Diecast aluminum
Relative humidity	max. 95% no condensation
Specification according to	EN 54-5
Weight:	
2000 mm	1550 g (3.42 lbs)
6000 mm	2315 g (5.10 lbs)
9000 mm	2680 g (5.91 lbs)
Dimensions	130 x 2000 - 130 x 9000 mm (dia.xH) 5.1 x 78.7 - 5.1 x 354.3 inch (dia.xH)

Part no.: 907284

The WMX5000 FS 3GD high temperature heat detectors are ATEX-approved for category 3, gas and dust, and are suitable for use in Ex zones 2 and 22. They have been specially designed for operation in industrial environments with aggressive media and very high application temperatures in the monitoring area. For example in exhaust ducts, engine test stands or machine tools. In addition to stated temperature detection, rapid rises in temperature can also be registered by the rate-of-rise method, for early fire detection. Designed for operation as a conventional detector. Expansion to a detector with Loop AP protocol via the KMX5000 AP communications module.

Optional accessories

Remote indicator	908499
KMX5000 AP communication module	905883
Relay module KMX5000 RK 3GD	925999

Not included in delivery

UniVario base	
Holder WMX FS, from	
250 °C (482 °F) to 600 °C (1112 °F)	894679
Terminating resistor 1.8 K / 0.5 W	675235

Connection / mounting

Connection cable standard detector	2-wire
Additional fault line connection	2-wire
Remote indication	2-wire
Recommended cable	JY (St) Y 2x2x0.8 mm (0.03 inch)
Conductor cross-section	max. 2.5 mm ² (AWG 13)

Note

Deviating from the defined standard lengths, the flexible sensor can be ordered in lengths of 500 - 9000 mm, see ordering table page 2/2. The sensor rod holder is designed for operation temperatures of up to 250 °C (482 °F). For higher operation temperatures, the WMX FS holder from 250 °C (482 °F) to 600 °C (1112 °F), part no. 894679, is to be used.

Approvals / marking

Type examination certificate (Minimax): BVS 07 ATEX E 157
Type examination certificate (Viking): BVS 18 ATEX E 076
Ex approval in acc. with NEC 500/505



Industrial detectors

Thermal detection - UniVario High temperature heat detector FS Flex, Ex

Brand	Designation	flex. Sensor rod** length (mm)	Order no.	Approvals / markings
Minimax	WMX5000 FS Flex 3GD L2000 MX	2000	907285	VdS G 207091
	WMX5000 FS Flex 3 GD L2000 MX SF*		928531	
	WMX5000 FS Flex 3 GD L6000 MX	6000	907286	CE 0786-CPR-20281
	WMX5000 FS Flex 3GD L6000 MX SF*		928534	
	WMX5000 FS Flex 3GD L9000 MX	9000	907287	FM APPROVED Ex nec
	WMX5000 FS Flex 3GD L9000 MX SF*		928537	
Viking	WMX5000 FS Flex 3GD L2000 VK	2000	928532	VdS G 221019
	WMX5000 FS Flex 3GD L2000 VK SF*		928533	
	WMX5000 FS Flex 3GD L6000 VK	6000	928535	CE 0786-CPR-21767
	WMX5000 FS Flex 3GD L6000 VK SF*		928536	
	WMX5000 FS Flex 3GD L9000 VK	9000	928538	FM APPROVED Ex nec
	WMX5000 FS Flex 3GD L9000 VK SF*		928539	

* silicone-free

** Order from 500 - 9000 mm length possible. Length specification in mm required.

WMX5000 FS Flex 3GD HTC

Part no.: 917525

High Temperature Cable (HTC) for high temperature applications. The ring-wave tube of the HTC-detector is for application temperatures up to 650 °C (1202 °F).

Technical specifications

Response temperatures	0 °C to +400 °C (+32 °F to +752 °F)
Weight	max. 3680 g (8.1 lbs)
Dimensions	130 x 2000 - 130 x 9000 mm (dia.xH) 5.1 x 78.7 - 5.1 x 354.3 inch (dia.xH)

Note

The ring-wave tube is significantly less flexible than other WMX5000 FS flex detectors.

Approvals / marking

Type examination certificate (Minimax): BVS 07 ATEX E 157
Type examination certificate (Viking): BVS 18 ATEX E 076

Otherwise like part no.: 907284

Brand	Designation	flex. Sensor rod* length (mm)	Order no.	Approvals / marking
Minimax	WMX5000 FS Flex 3GD HTC L9000 MX	9000	917527	VdS G 207091 Ex CE 0786-CPR-20281
Viking	WMX5000 FS Flex 3GD HTC L9000 VK		928858	VdS G 221019 Ex CE 0786-CPR-21767

* Order from 500 - 9000 mm length possible. Length specification in mm required.



Industrial detectors

Thermal detection - UniVario High temperature heat detector FS Flex, Ex

WMX5000 FS Flex Ex 400°C



Product features

- Robust flexible stainless steel heat sensor
- Freely configurable response temperatures and categories in accordance with EN 54-5, along with rate-of-rise and static responses. Configuration via DIP switches on the detector or SMX5000 service device
- Service interface, history memory
- For use in Ex zones 1, 2, 20, 21 and 22, Atex category 2, Gas/1,2 Dust

Technical specifications

Detection method	PT1000 sensor
Response categories	A1, A2, B, C, D, E, F, G, indices S, R
Response temperatures	0 °C to +400 °C (+32 °F to +752 °F)
Operating voltage	7.6 V - 28 V DC
Quiescent current	approx. 2.8 mA
Alarm current consumption	approx. 15 mA
Alarm indication	1 red LED
Normal operation indication	1 green LED, flashing
Fault indication current	approx. 15 mA
Fault indication	1 yellow LED (2nd line)
Operating temperature	-40 °C to +80 °C (-40 °F to +176 °F)
IP rating (EN 60529)	IP 66/67
Enclosure material	Diecast aluminum
Relative humidity	max. 95% no condensation
Specification according to	EN 54-5
Weight	520 - 1600 g (1.2 - 7.5 lbs)
Dimensions	130 x 2000 - 130 x 9000 mm (dia. x H) 5.1 x 78.7 - 5.1 x 354.3 inch (dia. x H)

Part no.: 912113

The WMX5000 FS Ex high temperature heat detectors are ATEX and IEC approved for category 2 gas and 1, 2 dust, and are suitable for use in Ex zones 1, 2, 20, 21 and 22. They have been specially designed for operation in industrial environments with aggressive media and very high application temperatures in the monitoring area. For example in exhaust ducts, engine test stands or machine tools. In addition to stated temperature detection, rapid rises in temperature can also be registered by the rate-of-rise method, for early fire detection. Designed for operation as a conventional detector. Expansion to a detector with Loop AP protocol via the KMX5000 AP Ex communications module.

Optional accessories

Safety barrier SBEx-9	933093
Safety barrier IS addressable 24 V	901324
KMX5000 AP Ex communication module	912086
Silicone-free design	

Not included in delivery

UniVario base	
Holder WMX FS, from 250 °C (482 °F) to 600 °C (1112 °F)	894679
Terminating resistor 1.8 K / 0.5 W	675235

Connection / mounting

Connection cable standard detector	2-wire
Additional fault line connection	2-wire
Remote indication	2-wire
Recommended cable	JE-Y (St) Y 2x2x0.8 mm (0.03 inch)
Conductor cross-section	max. 2.5 mm ² (AWG 13)

Note

The desired length of the flexible sensor must be specified in meters at the time of placing the order. The sensor rod holder is designed for operation temperatures of up to 250 °C (482 °F). For higher operation temperatures, the WMX FS holder from 250 °C (482 °F) to 600 °C (1112 °F) part no. 894679 is to be used.

Approvals / marking

Type examination certificate:	BVS 12 ATEX E120
IECEx conformity:	IECEx BVS 12.0073
Ex approval in acc. with NEC 500/505	



G 207091



0786-CPR-20281





Industrial detectors

Thermal detection - UniVario High temperature heat detector FS Flex, Ex



WMX5000 FS Flex Ex 400 °C 2 m (752 °F 79 inch)

Version with flexible hose of 2 m length (79 inch)

Part no.: 912114

Otherwise like part no.: 912113

Technical specifications

Response temperatures	0 °C to +400 °C (+32 °F to +752 °F)
Weight	680 g (1.5 lbs)
Dimensions	130 x up to 2000 mm (dia. x H) 5.1 x up to 78.73 inch (dia. x H)

WMX5000 FS Flex Ex 400 °C 6 m (752 °F 236 inch)

Version with flexible hose of 6 m length (236 inch)

Part no.: 912115

Otherwise like part no.: 912113

Technical specifications

Response temperatures	0 °C to +400 °C (+32 °F to +752 °F)
Weight	840 g (1.9 lbs)
Dimensions	130 x up to 6000 mm (dia. x H) 5.1 x up to 236.2 inch (dia. x H)

WMX5000 FS Flex Ex 400 °C 9 m (752 °F 354 inch)

Version with flexible hose of 9 m length (354 inch)

Part no.: 912116

Otherwise like part no.: 912113

Technical specifications

Response temperatures	0 °C to +400 °C (+32 °F to +752 °F)
Weight	1000 g (2.2 lbs)
Dimensions	130 x up to 9000 mm (dia. x H) 5.1 x up to 354.3 inch (dia. x H)



Industrial detectors

UniVario Detector accessories - Bases

Base MX5000

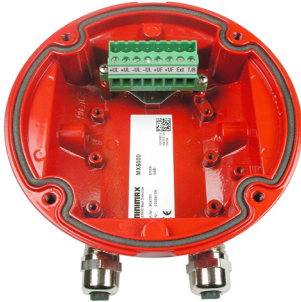

Technical specifications

Material	Aluminum
Relative humidity	max. 100 %
Cable diameter	5 - 9 mm
Gland	2 pcs. M16 x 1.5
Equipotential bonding terminal	no
Color	red
Ambient temperature	-40 °C to +100 °C (-40 °F to +212 °F)
Weight	310 g (0.7 lbs)

Part no.: 904701

Retaining base for UniVario industrial fire detectors, excluding 3GD and Ex detectors. Contains cable entries, EMC and environmental seals, connecting terminals and space for the optional relay module KMX5000 RK. Enables replacement of a detector without any terminal work.

Not included in delivery

End of line resistor 1.8 K / 0.5 W	675235
Dust protection cap MX5000	921694

Spare parts

Seal 127 x 2.9 / 1.6 mm	904752
Gland M 16 x 1.5 Ms	901861
Sealing cord 8 mm Viton 0.036 m	800605

Approvals

See corresponding UniVario detectors.

Brand	Designation	Order no.
Minimax	MX5000 MX	924440
	MX5000 MX SF (silicone-free)	914235
Viking	MX5000 VK	924441
	MX5000 VK SF (silicone-free)	926500



Industrial detectors

UniVario Detector accessories - Bases

Base MX5000 M20

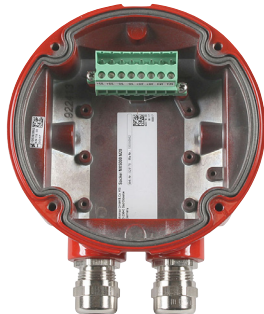

Technical specifications

Material	Aluminum
Relative humidity	max. 100 %
Cable diameter	5 - 13 mm
Gland	2 pcs. M20 x 1.5
Equipotential bonding terminal	no
Color	red
Ambient temperature	-40 °C to +100 °C (-40 °F to +212 °F)
Weight	530 g (1.2 lbs)

Part no.: 924178

Retaining base for UniVario industrial fire detectors, excluding 3GD and Ex detectors. Contains cable entries, EMC and environmental seals, connecting terminals and space for the optional relay module KMX5000 RK. Enables replacement of a detector without any terminal work.

Not included in delivery

End of line resistor 1.8 K / 0.5 W	675235
Dust protection cap MX5000	921694

Spare parts

Seal 127 x 2.9 / 1.6 mm	904752
Gland M 20 x 1.5 Ms	907084
Sealing cord 8 mm Viton 0.036 m	800605

Approvals

See corresponding UniVario detectors.

Base MX5000 3M16

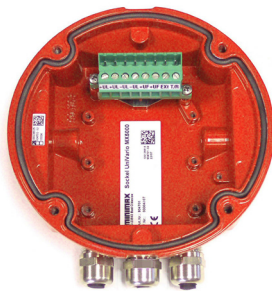

Technical specifications

Material	Aluminum
Relative humidity	max. 100 %
Cable diameter	5 - 9 mm
Gland	3 pcs. M16 x 1.5
Equipotential bonding terminal	no
Color	red
Ambient temperature	-40 °C to +100 °C (-40 °F to +212 °F)
Weight	350 g (0.8 lbs)

Part no.: 907011

Retaining base for UniVario industrial fire detectors, excluding 3GD and Ex detectors. Contains cable entries, EMC and environmental seals, connecting terminals and space for the optional relay module KMX5000 RK. The third cable gland allows the interface connection with detector remote indicators or similar devices.

Not included in delivery

End of line resistor 1.8 K / 0.5 W	675235
Dust protection cap MX5000	921694

Spare parts

Seal 127 x 2.9 / 1.6 mm	904752
Gland M 16 x 1.5 Ms	901861
Sealing cord 8 mm Viton 0.036 m	800605

Approvals

See corresponding UniVario detectors.



Industrial detectors

UniVario Detector accessories - Bases

Base MX5000 LCD



Part no.: 906127

Base for displaying status and signal messages from industrial fire alarms of the UniVario series. The LCD display gives information about sensor temperature, alarms or other operating states, depending on the detector type. Includes cable entries, EMC and environmental seals and connecting terminals. Enables replacement of a detector without any terminal work. The base MX5000 LCD must not be used in hazardous areas.

Not included in delivery

End of line resistor 1.8 K / 0.5 W	675235
Dust protection cap MX5000	921694

Technical specifications

Operating voltage	by means of the detector
Operating current	0.3 mA
Material	Aluminium
Relative humidity	max. 100 %
Cable diameter	5 -9 mm
Gland	2 pcs. M16 x 1.5
Equipotential bonding terminal	no
Colour	red
Ambient temperature	-20 °C to +70 °C (-4 °F to +158 °F)
Weight	350 g (0.8 lbs)

Spare parts

Seal 127 x 2.9 / 1.6 mm	904752
Gland M 16 x 1.5 Ms	901861
Sealing cord 8 mm Viton 0.036 m	800605

Approvals

None

Base MX5000-I

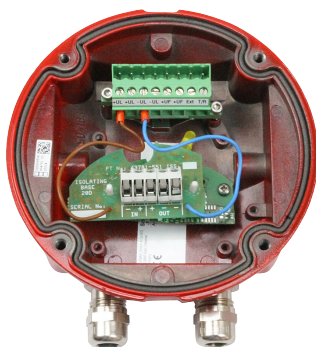

Part no.: 912493

Detector base for installation of the UniVario industrial fire detectors in the LoopAP ringbus. Contains cable glands, EMC and environmental sealing as well as terminals. Not suitable for use in hazardous explosive areas. The installed dual isolator increases the operational safety of the LoopAP ringbus in the event of a short-circuit.

Not included in delivery

Dust protection cap MX5000	921694
----------------------------	--------

Spare parts

Seal 127 x 2.9 / 1.6 mm	904752
Gland M 16 x 1.5 Ms EMC FKM	901861
Sealing cord 8 mm Viton 0.036 m	800605

Note

Deviating temperature range to the UniVario detectors.

Approvals

None

Technical specifications

Material	Aluminium
Relative humidity	max. 100 %
Cable diameter	5 - 9 mm
Gland	2 pcs. M16 x 1.5
Equipotential bonding terminal	no
Colour	red
Ambient temperature	-20 °C to +60 °C (-4 °F to +140 °F)
Weight	530 g (1.2 lbs)



Industrial detectors

UniVario Detector accessories - Bases

Base MX5000 NPT



Part no.: 922431

Retaining base for UniVario industrial fire detectors. Contains cable glands, EMC and environmental sealing as well as terminals. Enables replacement of a detector without any terminal work.

Not included in delivery

End of line resistor 1.8 K / 0.5 W
Dust protection cap MX5000

675235
921694

Spare parts

Seal 127 x 2.9 / 1.6 mm

904752

Technical specifications

Material	Aluminum
Relative humidity	max. 100 %
Gland	no
Thread	1/2" - 14 NPT
Equipotential bonding terminal	yes
Color	red
Ambient temperature	-40 °C to +100 °C (-40 °F to +212 °F)
Weight	530 g (1.2 lbs)

Approvals

See corresponding UniVario detector.



Industrial detectors

UniVario Detector accessories - Bases

Base MX5000 Ex

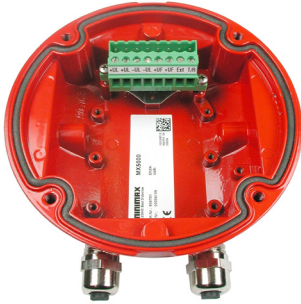

Technical specifications

Material	Aluminum
Relative humidity	max. 100 %
Cable diameter	5 - 9 mm
Gland	2 pcs. M16 x 1.5
Equipotential bonding terminal	yes
Color	red
Ambient temperature	-40 °C to +100 °C (-40 °F to +212 °F)
Weight	530 g (1.2 lbs)

Part no.: 912082

Detector base for installation of the UniVario industrial fire detectors of the 3GD and Ex series. Contains cable inlets, EMC and environmental sealing as well as terminals. Thus detectors can be replaced without requiring connecting work.

Not included in delivery

End of line resistor 1.8 K / 0.5 W	675235
Dust protection cap MX5000	921694

Spare parts

Seal 127 x 2.9 / 1.6 mm	904752
Gland M 16 x 1.5 Ms Ex	904652
Sealing cord 8 mm Viton 0.036 m	800605

Approvals

See corresponding UniVario detector.

Brand	Designation	Order no.
Minimax	MX5000 Ex MX	924443
	MX5000 Ex MX SF (silicone-free)	924766
Viking	MX5000 Ex VK	924442
	MX5000 Ex VK SF (silicone-free)	924767

Base MX5000 M20 Ex

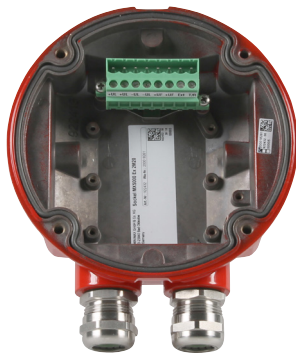

Technical specifications

Material	Aluminum
Relative humidity	max. 100 %
Cable diameter	7 - 12 mm
Gland	2 pcs. M20 x 1.5
Equipotential bonding terminal	yes
Color	red
Ambient temperature	-40 °C to +100 °C (-40 °F to +212 °F)
Weight	530 g (1.2 lbs)

Part no.: 922432

Detector base for installation of the UniVario industrial fire detectors of the 3GD and Ex series. Contains cable entries, EMC and environmental seals and connecting terminals. Enables replacement of a detectors without any terminal work.

Not included in delivery

End of line resistor 1.8 K / 0.5 W	675235
Dust protection cap MX5000	921694

Spare parts

Seal 127 x 2.9 / 1.6 mm	904752
Gland M 20 x 1.5 Ms Ex nickel plated	925958
Sealing cord 12 mm Viton 0.036 m	925957

Approvals

See corresponding UniVario detector.



Industrial detectors

UniVario Detector accessories - Bases

Base MX5000 M20 NG Ex



Technical specifications

Material	Aluminum
Relative humidity	max. 100 %
Gland	M20 x 1.5
Equipotential bonding terminal	yes
Color	red
Ambient temperature	-40 °C to +100 °C (-40 °F to +212 °F)
Weight	530 g (1.2 lbs)

Part no.: 924179

Detector base for installation of the UniVario industrial fire detectors and the 3GD and Ex series. Without cable glands. Contains cable inlets, EMC and environmental sealing as well as terminals. Thus detectors can be replaced without requiring connecting work.

Not included in delivery

Cable gland M20 x 1.5 Vent	934428
Cable gland M20 x 1.5 Ms	907084
Cable gland M20 x 1.5 Ex Ms	925958
End of line resistor 1.8 K / 0.5 W	675235
Dust protection cap MX5000	921694

Spare parts

Seal 127 x 2.9 / 1.6 mm	904752
Sealing cord 8 mm Viton 0.036 m	800605

Approvals

See corresponding UniVario detector.

Brand	Designation	Order no.
Minimax	MX5000 M20 NG Ex MX	934432
	MX5000 M20 NG Ex MX SF (silicone-free)	934433
Viking	MX5000 M20 NG Ex VK	934434
	MX5000 M20 NG Ex VK SF (silicone-free)	934435



Industrial detectors

UniVario Detector accessories

Console MX5000 Flame detector



Part no.: 904758

Console for the installation of UniVario flame detectors outside of monitored areas, e.g. air ducts, machine tools, containers or silos. Easy access to the detector. Bayonet socket for reliable, vibration-proof hold. Antistatic material for use in hazardous areas up to zones 1 and 21.

Included in delivery

Console with flat sealing and springs	906148
Screw M5	904341
Self-tapping screw	765233
Blind rivets	885078
O-ring	904759
Installation drawing	906970

Technical specifications

Material	PA6 99/0701 EC
Dimensions	138 x 15 mm (WxH) 6.6 x 0.6 inch (WxH)
Colour	black
Ambient temperature	-20 °C to +100 °C (-4 °F to +212 °F)
Weight	145 g (0.3 lbs)

Console MX5000 Heat detector



Part no.: 906969

Console for the installation of UniVario heat detectors on e.g. air ducts, dryers or machine tools. Easy access to the detector. Bayonet socket for reliable, vibration-proof hold. Antistatic material for use in hazardous areas up to zones 1 and 21.

Included in delivery

Console with flat sealing and springs	906148
Screw M5	904341
Self-tapping screw	765233
Blind rivets	885078
O-ring	904759
Installation drawing	906970

Technical specifications

Material	PA6 99/07001 EC
Dimensions	138 x 16.2 mm (WxH) 5.4 x 0.6 inch (WxH)
Colour	black
Ambient temperature	-20 °C to +100 °C (-4 °F to +212 °F)
Weight	145 g (0.3 lbs)



Industrial detectors

UniVario Detector accessories - Modules

KMX5000 AP communication module

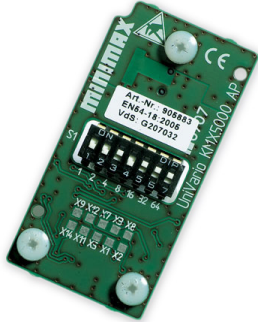

Product features

- Communication module for constant signaling of operating condition, alarms and faults via Loop AP protocol
- Ring bus connection, no additional power supply
- Integration in UniVario series detectors

Technical specifications

Connection	10 spring contacts (module/detector)
Operating voltage	17 V - 28 V DC
Operating current	approx. 0.3 mA
Communication protocol	Loop AP
Addressing	8 position DIP switch
Operating temperature	-40 °C to +80 °C (-40 °F to +176 °F)
Relative humidity	5 to 85% no condensation
Specification according to	EN 54 Part 18
Weight	15 g (0.03 lbs)
Dimensions	54 x 28 x 19.5 mm (LxWxH) 2.1 x 1.1 x 0.8 inch (LxWxH)

Part no.: 905883

Communication module for the operation of UniVario detectors on fire alarm panels with Loop AP protocol. By simply plugging the module into the detector, a conventional detector is turned into an analog addressable detector. The detector address is set via DIP switches. Power supply and communications are connected via the ring bus; no additional power supply is required.

The communication module can be used for all standard and 3GD (Zone 2 and 22) UniVario detectors.

Included in delivery

1 KMX5000 AP communication module
Pan-head screw and Spacer

Connection / mounting

Plug-in module in UniVario series detectors

Approvals / marking



G 207032



0786-CPD-20315





Industrial detectors

UniVario Detector accessories - Modules

KMX5000 AP Ex communication module

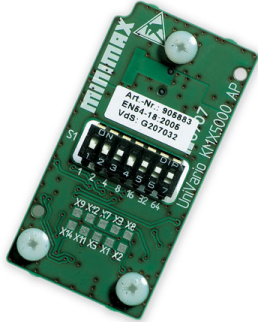

Product features

- Communication module for constant signaling of operating condition, alarms and faults via Loop AP protocol
- Ring bus connection, no additional power supply
- Integration in UniVario Ex series detectors

Technical specifications

Connection	10 spring contacts (module/detector)
Operating voltage	14 V - 22 V DC
Operating current	approx. 0.3 mA
Communication protocol	Loop AP
Addressing	8 position DIP switch
Operating temperature	-40 °C to +80 °C (-40 °F to +176 °F)
Relative humidity (IEC 721-3-3)	5 to 85% no condensation
Specification according to	EN 54 Part 18
Weight	15 g (0.03 lbs)
Dimensions	54 x 28 x 19.5 mm (LxWxH) 2.1 x 1.1 x 0.8 inch (LxWxH)

Part no.: 912086

Communication module for the operation of UniVario detectors on fire alarm panels with Loop AP protocol. By simply plugging the module into the detector, a conventional detector is turned into an analogue addressable detector. The detector address is set via a DIP switch. Power supply and communications are connected via the ring bus; no additional power supply is required. The KMX5000 AP Ex communication module is designed for integration into UniVario series detectors and may be used in hazardous areas.

Included in delivery

1 KMX5000 AP Ex communication module
Pan-head screw and Spacer

Connection / mounting

Plug-in module in UniVario Ex series detectors

Approvals / marking



G 207032



0786-CPD-20315





Industrial detectors

UniVario Detector accessories - Modules

Relay module KMX5000 RK

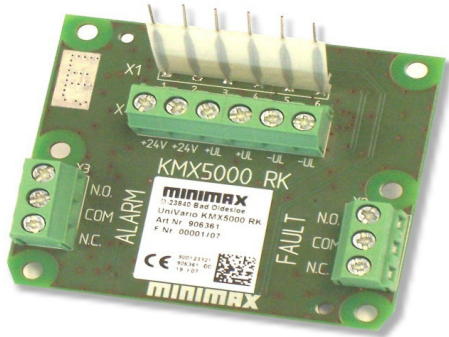

Part no.: 906361

Communication module for the operation of UniVario detectors, independent of any fire detection system. Dry contacts for alarm and fault signaling allow the detectors to be used as stand-alone units, in any fire and hazard detection system or in building management and control systems. The KMX5000 RK communication module is designed to be integrated into the UniVario detector base MX5000 and must not be used in hazardous areas.

Product features

- Dry changeover contacts for alarm and fault signaling
- Integration into MX5000 detector base

Included in delivery

Relay module KMX5000 RK
Jumper
Installation material

Technical specifications

Connection	6-conductor ribbon cable
Operating voltage	24 V (14 V - 29 V) DC
Quiescent current	approx. 7 mA
Current consumption with alarm relay active	approx. 20 mA
Current consumption with alarm relay and fault relay active	approx. 30 mA
Voltage load, contacts	max. 60 V DC, 25 V AC
Current load, contacts	max. 1 A
Fault indication	1 yellow LED (2nd line)
Operating temperature	-40 °C to +80 °C (-40 °F to +176 °F)
Relative humidity	5 to 85% no condensation
Specification according to	EN 54 Part 18
Weight	50 g (0.1 lbs)
Dimensions	64 x 24 x 57 mm (LxWxH) 2.5 x 0.9 x 2.2 inch (LxWxH)

Connection / mounting

Conductor cross-section min. 0.5 mm² (AWG 20)
max. 2.5 mm² (AWG 13)

Note

Not for use in potentially explosive atmospheres.

312-810_009 / A/04 / 2022-Apr-22 / en
The contents of this publication are subject to modifications without notice. All rights reserved.

Brand	Designation	Order no.	Approvals / marking
Minimax	Relay module KMX5000 RK MX	929143	0786-CPR-20314 G 208058
Viking	Relay module KMX5000 RK VK	929144	0786-CPR-20314 G 221020

Trusted above all.

Viking GmbH | Industriestr. 10/12 | D-23840 Bad Oldesloe | www.viking-emea.com





Industrial detectors

UniVario Detector accessories - Modules

Relay module KMX5000 RK 3GD



Product features

- Dry changeover contacts for alarm and fault signaling
- Integration into UniVario base

Technical specifications

Connection	6-conductor ribbon cable
Operating voltage	24 V (14 V - 29 V) DC
Power consumption KMX5000 RK 3GD only (without detector current) in normal operation (fault relay on)	approx. 18 mA at 24 V
Power consumption KMX5000 RK 3GD only (without detector current) with activated alarm and fault relay	approx. 35 mA at 24 V
Power consumption KMX5000 RK 3GD only (without detector current) with deactivated alarm and fault relay	approx. 6 mA at 24 V
Voltage load, contacts	max. 60 V DC, 25 V AC
Current load, contacts	max. 2 A
Fault indication	1 yellow LED (2nd line)
Operating temperature	-40 °C to +80 °C (-40 °F to +176 °F)
Relative humidity	5 to 85% no condensation
Weight	50 g (0.1 lbs)
Dimensions	64 x 24 x 57 mm (LxWxH) 2.5 x 0.9 x 2.2 inch (LxWxH)

Part no.: 925999

Communication module for the operation of UniVario 3GD detectors (zone 2 and 22), independent of any fire detection system. Dry contacts for alarm and fault signaling allow the detectors to be used as stand-alone units, in any fire and hazard detection system or in hazard management and control systems. The KMX5000 RK 3GD communication module is designed to be integrated into the UniVario detector base MX5000 Ex and may only be used in Ex zones 2 and 22.

Included in delivery

Relay module KMX5000 RK 3GD
Jumper
Installation material

Connection / mounting

Conductor cross-section min. 0.5 mm² (AWG 20)
max. 2.5 mm² (AWG 13)

Note

Use only with UniVario 3GD detectors in Ex zones 2 and 22.

Brand	Designation	Order no.	Approvals / marking
Minimax	Relay module KMX5000 RK 3GD MX	926825	CE 0786-CPR-20314 VdS G 208058 FM APPROVED Ex
Viking	Relay module KMX5000 RK 3GD VK	926826	CE 0786-CPR-20314 VdS G 221020 FM APPROVED Ex



Industrial detectors

UniVario Detector accessories

Sample case UniVario



Part no.: 934772

Sample case for the UniVario industrial fire detector series (without equipment).

Product features

- 2 chrome handles with PS-strengthening
- 1 integrated telescopic handle
- 2 integrated corner wheels
- 2 locks 1270
- 1 combination lock centered
- Logo „UniVario“ on case lid

Technical specifications

Material case	aluminum
Weight (unfilled)	7 kg (15.43 lbs)
Dimensions inside	554 x 313 x 225 +65 mm 21.81 x 12.32 x 8.86 +2.56 inch

Included in delivery

1 aluminum case with foam inserts. The recesses are exactly adapted to the articles listed under accessories.

Accessories

Removable foam insert:

6 x Sensor unit YMX5000	
2 x Replaceable optics YMX5000	
1 x Connecting cable M12x1 2 m	921039
1 x Protection/locking unit M12	920945
1 x Mounting angle YMX5000	926843
1 x Installation kit YMX5000	916595
incl. Equipotential bonding lug YMX5000	932002
1 x Installation kit YMX5000 LSP	916518
1 x Socket YMX5000	923016

Foam insert in the base:

2 x Control unit YMX5000	
1 x UniVario WMX5000 single hole	905847
1 x UniVario flame detector FMX5000	
2 x UniVario detector base	
1 x Bracket MX5000	904757
1 x Pipe mounting bracket	921978
1 x Communication module KMX5000 AP Ex	912086
1 x Relay module KMX5000 RK 3GD	925999
1 x Service device SMX5000	906136
1 x variable recess for tools	



Industrial detectors

UniVario Detector accessories

Isolator ISX 284 3GD



Technical specifications

Material	Aluminum
Fault indication inside	yellow LED
IP rating (EN 60529)	IP 66
Colour	grey
Ambient temperature	-20 °C to +60 °C (-4 °F to +140 °F)
Weight	1.2 kg (2.6 lbs)
Dimensions	90 mm (dia.) 3.5 inch (dia.)

Part no.: 915864

Isolator XP and DIS for the separation of individual line sections in the event of short circuits in ringbus operation with approval for ATEX category 3 gas and dust. Are suitable for use in Ex zones 2 and 22.

Approvals / marking

EC type approval certificate:

BVS 11 ATEX E114



Air shield MX5000



Technical specifications

Material	Aluminum
Compressed air operation	min. 0.01 MPa (1.5 psi)
Flow rate	min. 1 m³/h (35 ft³/h)
Hose connection	6 mm (0.24 inch)
Weight	0.47 kg (1.0 lbs)

Part no.: 914322

The air shield is only intended for use with UniVario flame detectors. It is used to prevent contamination of the optic and reflector of the detector. Only use in dry dusty or powder-containing environments.

Note

Image shows air shield complete mounted to detector

Included in delivery

Air shield with gland G1/4"-6 (6 mm hose), without detector

Not included in delivery

Hose 6x4 PUN	914329
Hose 6x4 PUN ANTISTAT (Ex)	919559
optional:	
Gland G1/4"-8 (8 mm hose)	918670
Hose 8x6 PA FL	845956
Hose 8x6 PUN ANTISTAT (Ex)	919560



Industrial detectors

UniVario Detector accessories

Air shield MX5000



Technical specifications

Material	Plastic, electroconductive
Compressed air operation	0.1 MPa (14.5 psi) - 0.6 MPa (87 psi)
Flow rate	adjustable
Hose connection	8 mm (0.31 inch) (outside) 6 mm (0.24 inch) (inside)
Weight	0.25 kg (0.55 lbs)

Part no.: 923137

The air shield (plastic version) is intended for use with UniVario flame detector type FMX5000IR 3GD, FMX5000 IR Ex and FMX5000 IR Ex ST only. It is used to prevent contamination of the optic and reflector of the detector. Only use in dry dusty or powder-containing environments. Optimized purge effect and air consumption.

Note

Optionally usable as console mounting in combination with the accessory mounting set LSP, part no. 924724. Image shows air shield mounted to detector.

Included in delivery

Air shield MX5000 with fitting IQSG 188 G, part no. 923144, and screws NIG M5, part no. 904341, without socket.

Not included in delivery

Accessory mounting set LSP 924724

Approvals / marking





Industrial detectors

UniVario Detector accessories

Air shield MX5000 pulse



Technical specifications

Material	Aluminium
Compressed air operation	0.1 MPa to 0.5 MPa (14.5 psi to 72.5 psi)
Flow rate	depending on the setting
Hose connection	8 mm (0.31 inch)
Weight	0.47 kg (1.0 lbs)

Note

Image presentation air shield complete mounted to detector

Part no.: 919551

The air shield pulse is only intended for use with UniVario flame detectors. In combination with the pulse air purging unit the air shield pulse is preventing contamination on the lens and the reflector of the detector. Only use in dry dusty or powder-containing environments. By the pulse mode, the energy costs are significantly reduced.

Included in delivery

Air shield pulse with gland G1/4"-8 (8 mm hose), without detector

Not included in delivery

Pulse air purging unit	919510
Hose 8x6 PA FL	845956
Hose 8x6 PUN ANTISTAT (Ex)	919560
optional:	
Gland G1/4"-6 (6 mm hose)	918669
Hose 6x4 PUN	914329
Hose 6x4 PUN ANTISTAT (Ex)	919559

Pulse air purging unit



Technical specifications

Material	Aluminium
Compressed air at the inlet	min. 0.5 MPa, max. 1.0 MPa (5 bar to 10 bar)
Compressed air at the outlet	min. 0.1 MPa, max. 0.5 MPa (1 bar to 5 bar), adjustable
Purity classes of compressed air according to ISO 8573-1:	
Class oil aerosol content	1 - 2
Class humidity	4
Class solid particle content	1 - 2
Connectable air purging attachment	max. 4
Ambient temperature	0 °C to +50 °C (+32 °F to +122 °F)
Power supply	230 V AC, 10 W
Hose connection	8 mm (0.31 inch)
Weight	4.3 kg (9.5 lbs)

Part no.: 919510

The pulse purging unit is used for optical flame and spark detectors. The unit supplies air purging attachments with compressed air. The unit ensures short compressed air blasts by a time-controlled magnetic valve. The cleaning effect of the air purging attachment is increased. The consumption of compressed air is decreased. Only dry dust and powdery soiling can be removed effectively.

Not included in delivery

Compressed air inlet:	
Fitting IQSG-G1/2"-8 (8 mm hose)	919554
Coupling connector NW7,2 G1/2"	919555
Hose 8x6 PA FL	845956
Hose 8x6 PUN ANTISTAT (Ex)	919560

Compressed air outlet:

Fitting IQSG-G1/2"-8 (8 mm hose)	919554
Coupling connector IQSLV2-G1/2"-8 (8 mm hose)	919556
Coupling connector IQSLV3-G1/2"-8 (8 mm hose)	919557
Coupling connector IQSLV4-G1/2"-8 (8 mm hose)	919558

Approvals / marking





Industrial detectors

UniVario Detector accessories

Pulse air purging unit 24 V



Technical specifications

Material	Aluminum
Compressed air at the inlet	min. 0.5 MPa, max. 1.0 MPa (5 bar to 10 bar)
Compressed air at the outlet	min. 0.1 MPa, max. 0.5 MPa (1 bar to 5 bar), adjustable
Purity classes of compressed air according to ISO 8573-1:	
Class oil aerosol content	1 - 2
Class humidity	4
Class solid particle content	1 - 2
Connectable air purging attachment	max. 4
Ambient temperature	0 °C to +50 °C (+32 °F to +122 °F)
Power supply solenoid valve	24 V DC, 8 W
Hose connection	8 mm (0.31 inch)
Weight	4.6 kg (10.1 lbs)

Part no.: 922988

The pulse purging unit is used for optical flame and spark detectors. The unit supplies air purging attachments with compressed air. The unit ensures short compressed air blasts by a time-controlled magnetic valve. The cleaning effect of the air purging attachment is increased. The consumption of compressed air is decreased. Only dry dust and powdery soiling can be removed effectively. The pulse control of the solenoid valve is performed by external 24 V power supply.

Not included in delivery

Compressed air inlet:

Fitting IQSG-G1/2"-8 (8 mm hose)	919554
Coupling connector NW7,2 G1/2"	919555
Hose 8x6 PA FL	845956
Hose 8x6 PUN ANTISTAT (Ex)	919560

Compressed air outlet:

Fitting IQSG-G1/2"-8 (8 mm hose)	919554
Coupling connector IQSLV2-G1/2"-8 (8 mm hose)	919556
Coupling connector IQSLV3-G1/2"-8 (8 mm hose)	919557
Coupling connector IQSLV4-G1/2"-8 (8 mm hose)	919558

Approvals / marking





Industrial detectors

UniVario Detector accessories

Weather protection MX5000 complete

**Part no.: 910134**

Additional equipment – weather protection for flame detectors of the Uni Vario series for use in case of increased solar radiation or exposure to harsh weather conditions.

Connection / mounting

Fasten the weather protection to the detector.

Included in delivery

Mounting material

Technical specification

Material	Stainless steel, 0.5 mm (0.02 inch)
Dimensions	140 x 110 x 220 mm (WxHxL) 5.5 x 4.3 x 8.7 inch (WxHxL)
Colour	inside black
Weight	300 g (0.67 lbs)

Dust protection cap MX5000

**Part no.: 921694**

Protection against pollution of UniVario detectors before commissioning.

Included in delivery

1 Dust protection cap MX5000 (individual delivery)

Connection / mounting

Put the dust protection cap over the base.

Technical specification

Material	EVA
Dimensions	130 x 11 mm (DxH) 5.1 x 0.4 inch (DxH)
Weight	23 g (0.05 lbs)



Industrial detectors

UniVario accessories

Reflector ring FMX5000 IR

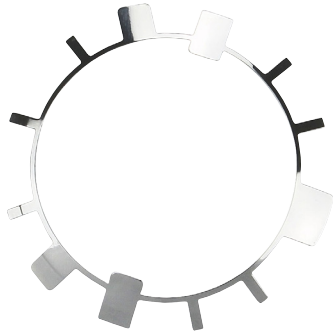

Part no.: 908351

Spare part for FMX5000 IR detectors, part no. 907481, which were delivered before the introduction of the unit optics.

Mounting example





Industrial detectors

IR flame detector

FMX3511



Product features

- High degree of immunity against false alarms, e.g. from hot surfaces
- A microcontroller monitors the functionality. Faults can be indicated on the detector or on a separate line
- Connection of remote indicator possible
- Single optic test

Technical specifications

Detection method	2 IR Sensors
Sensitivity class	3
Viewing angle	60 °
Operating voltage	7.6 V - 15 V DC
Quiescent current	approx. 3 mA
Alarm current	approx. 18 mA
Alarm indication	1 LED red
Fault indication current	approx. 7 mA
Fault indication	1 LED yellow
Number of detectors per line	max. 4
Electrostatic shielding	required
Operating temperature	-25 °C to +80 °C (-13 °F to +176 °F)
IP rating (EN 60529)	IP 65
Enclosure material	Diecast aluminum, RAL 5009-blue
Relative humidity	max. 100% at + 35 °C (+95 °F)
Specification according to	EN 54 Part 10
Weight	600 g (1.3 lbs)
Dimensions	127 x 125 x 70 mm (WxHxD) 5 x 4.9 x 2.8 inch (WxHxD)

Part no.: 801618

Double infrared flame detector FMX3511 for the detection of open flames. Optic-test monitors the functionality of the detector. Designed for use in rough industrial environments. Equipped for operation as a conventional detector.

Not included in delivery

End of line-resistor 1.8 K / 0.5 W	675235
Sun screen	801277
Remote indicator LMX5000	908499
Plug for the pollution test	801079
Mounting device bracket with insulation (included in delivery with type BG)	801284
Mounting device console 125x80Ø60 (included in delivery with type Console)	801280
Mounting device console 125x80Ø60 LSP (included in delivery with type Console LSP)	801281

Connection / mounting

Connection cable standard detector	2-wire
Recommended cable	LiYCY 5x0.5 mm ² (AWG 20)
Cable gland	M16x1.5, Brass nickel-plated, EMV

Approvals / marking



G 296016



0786-CPD-20312





Industrial detectors

IR flame detector

FMX3511 BG

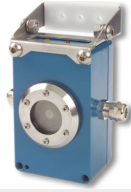
**Part no.: 891319**

FMX3511 with mounting brackets

Technical specifications

Weight	750 g (1.7 lbs)
Dimensions	127 x 155 x 70 mm (WxHxD) (5.0 x 6.1 x 2.8 inch)

Included in delivery

Mounting brackets with insulation

901284

Otherwise like part no. 801618

FMX3511 console

**Part no.: 801609**

FMX3511 with console assembly

Technical specifications

Weight	950 g (2.1 lbs)
Dimensions	127 x 150 x 75 mm (WxHxD) (4.0 x 5.9 x 2.9 inch)

Included in delivery

Bracket housing 125x80Ø60

801280

Otherwise like part no. 801618

FMX3511 console LSP

**Part no.: 801610**

FMX3511 with console assembly including air purge

Technical specifications

On site compressed air supply	Pressure range 0.8 - 1.5 bar
Hose connection	6 mm (0.24 inch)
Weight	970 g (2.14 lbs)
Dimensions	141 x 150 x 75 mm (WxHxD) (5.6 x 5.9 x 3 inch)

Included in delivery

Bracket housing 125x80Ø60 LSP

801281

Not included in delivery

Air supply

Hose 6x4 PUN

914329

Hose 6x4 PUN ANTISTAT (Ex)

919559

Otherwise like part no. 801618

FMX3511 SF

Part no.: 801619

Silicone-free flame detector

FMX3511 0,2 sec

Part no.: 902767

Flame detectors with fast response within range of milliseconds for monitoring (e.g. tooling machine).

FMX 3511 Overview Part numbers

Type	Standard	SF	0,2 sec	SF 0,2 sec
FMX 3511	801618	801619	902532	902767
FMX 3511 BG	891319	800029	902533	902768
FMX 3511 console	801609	-	902534	-
FMX 3511 console LSP	801610	-	-	-



Industrial detectors

IR flame detector, Ex

FMX3501 Ex



Product features

- High degree of immunity against false alarms, e.g. from hot surfaces
- A microcontroller monitors the functionality. Faults can be indicated on the detector or on a separate line
- Connection of remote indicator possible
- Single optic-test
- For use in Ex zones 1, 2 and 22

Technical specifications

Detection method	2 IR Sensors
Sensitivity class	3
Viewing angle	60 °
Operating voltage	7.6 V - 15 V DC
Quiescent current	approx. 3 mA
Alarm current	approx. 18 mA
Alarm indication	1 LED red
Fault indication current	approx. 7 mA
Fault indication	1 LED yellow
Number of detectors per line	max. 4
Electrostatic shielding	required
Operating temperatur	-25 °C to +80 °C (-4 °F to +176 °F)
IP rating (EN 60529)	IP 65
Enclosure material	Diecast aluminum, RAL 5009-blue
Relative humidity	max. 100% at +35 °C (+95 °F)
Weight	600 g (1.3 lbs)
Dimensions	127 x 125 x 70 mm (WxHxD) 5 x 4.9 x 2.8 inch (WxHxD)

Part no.: 903133

Infrared flame detector FMX3501 Ex for the detection of open flames. Optic-test monitors the functionality of the detector. Designed for use in rough industrial environments. Equipped for operation as a conventional detector. Infrared flame detector FMX3501 Ex are ATEX-approved for category 2 gas and 3 dust and are suitable for use in Ex zones 1 and 22. Intrinsically safe flame detectors must be connected by correspondingly marked cables to explosion hazard barriers.

Not included in delivery

End of line-resistor 1.8 K / 0.5 W	675235
Safety barrier SBEx-9	933093
Sun screen	801277
Card clock modul ext.detector identifier	831953
Plug for the pollution test	801079
Mounting device bracket with insulation (included in delivery with type BG)	801284

Connection / mounting

Connection cable standard detector	2-wire
Recommended cable	OB-BL-PAAR-CY 2x2x0.5 mm ² (AWG 20)
Cable gland	M16x1.5, Brass nickel-plated, EMV

Approvals / marking

Type examination certificate: DMT 02 ATEX E224



G 296016



0786-CPD-20312





Industrial detectors

IR flame detector, Ex

FMX3501 Ex BG

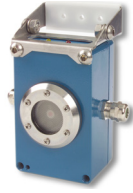
**Part no.: 800000**

FMX3501 with mounting brackets

Included in delivery

Mounting brackets with insulation

801284

Otherwise like part no. 903133

Technical specifications

Weight	882 g (1.9 lbs)
Dimensions	127 x 155 x 70 mm (WxHxD) (5.0 x 6.1 x 2.8 inch)

FMX3501 Ex SF

Part no.: 903134

Silicone-free flame detector

FMX3501 Ex 0,2 sec

Part no.: 903135

Flame detectors with fast response within range of milliseconds for monitoring (e.g. tooling machine)

FMX3501 Ex T

Part no.: on request

Flame detectors with non-latching alarm

FMX 3501 Ex Overview Part numbers

Type	Standard	SF	0,2 sec	0,2 sec SF
FMX 3501 Ex	903133	903134	903135	on request
FMX 3501 Ex BG	800000	902769	902721	on request

FMX 3501 Ex T Overview Part numbers

Type	Standard	SF	0,2 sec	0,2 sec SF
FMX 3501 Ex T	on request	on request	on request	on request
FMX 3501 Ex T BG	on request	on request	on request	on request



Industrial detectors

UV flame detector, Ex

UMX3001 Ex

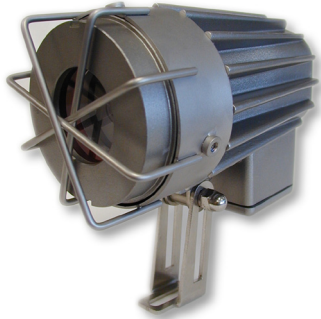

Product features

- Wide field of view
- Fast flame response
- High water and dust protection (IP 67)
- For use in Ex zones 1, 2, 21 and 22

Technical specifications

Detections method	UV-Sensor
Viewing angle	110 °
Number of detectors per line	max. 4
Operating voltage	7.6 V - 13.2 V DC
Quiescent current	approx. 1 mA
Alarm current	approx. 20 mA
Alarm indication	1 LED red
Electrostatic shielding	required
Operating temperature	-20 °C to +70 °C (-4 °F to +158 °F)
IP rating (EN 60529)	IP 67
Enclosure material	Diecast aluminum, silver grey
Relative humidity	max. 95% at +35 °C (95 °F)
Weight	3 kg (6.6 lbs)
Dimensions	88 x 190 mm (dia. x H) 3.5 x 7.5 inch (dia. x H)

Part no.: 903802

UV flame detector for the detection of open flames. Designed for use in rough industrial environments. Equipped for operation as a conventional detector. The UMX3001 Ex flame detectors are ATEX-approved for category 2 gas and dust and are suitable for use in Ex zones 1 and 21. The UMX3001 Ex has a pressure resistant casing.

Not included in delivery

End of line-resistor 1.8 K / 0.5 W 675235

Connection / mounting

Connection cable standard detector 2-wire
 Additional connection latching indication 1-wire
 Recommended cable LIYCY grey 5x0.5 mm²
(AWG 20)
 Conductor cross-section max. 2.5 mm² (AWG 13)
 Conducting cable diameter 5 mm to 9 mm (0.20 to 0.35 inch)
 Cable gland metal, EMV, Ex M16x1.5

Approvals / marking

Type examination certificate: BVS 04 ATEX E 168 X





Industrial detectors

Detector accessories

Mounting device console 80x75 Ø54 (3.1x2.9 Ø 2.1 inch)



Technical specifications

Material	Plastic POM
Color	black
Weight	160 g (0.4 lbs)
Dimensions	112 x 112 mm (LxW) (4.4 x 4.4 inch (LxW))

Part no.: 902898

Mounting device to support gas emission detectors
GMX1001CO I.

Included in delivery

1 Mounting device console 80x75 Ø54 complete	902896
2 Countersunk screw DIN923-M5x10 St	835703
5 Self-taping screw DIN7981 C4.2x16	885080
5 Blind rivet 3.2x16 alu	885078
1 O-ring 60x3 Viton	132587
2 Hex screw DIN933-M8x20-A2	772552
2 Spring washer DIN127 B8-1.4310	820707

Not included in delivery

Adhesive Loctite AVX 586, 50 ml	886226
---------------------------------	--------

Note

Do not install the mounting device console in
explosion-hazard zone 1.



Industrial detectors

Detector accessories

Mounting device console 125x80 Ø60 (4.9x3.1 Ø 2.3 inch)



Technical specifications

Material	Plastic PETP
Colour	black
Weight	350 g (0.8 lbs)
Dimensions	120 x 150 mm (LxW) (4.7 x 5.9 inch (LxW))

Part no.: 801280

Mounting device to support flame detector FMX3511.

Included in delivery

1 Mounting device console 125x80 Ø60	801069
2 Countersunk screw DIN923-M5x10 St	835703
5 Self-taping screw DIN7981 C4.2x16	885080
5 Blind rivet 3.2x16 alu	885078
1 O-ring 70x3 Viton 70°SH	800774
2 Hex screw DIN933-M8x20-A2	772552
2 Spring washer DIN127 B8-1.4310	820707

Not included in delivery

Adhesive LoctiteAVX 586, 50 ml	886226
--------------------------------	--------

Note

Do not install the mounting device console in explosion-hazard zone 1

Mounting device console 125x80 Ø60 (4.9x3.1 Ø 2.3 inch) LSP

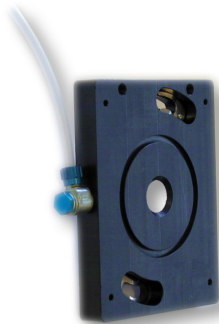

Technical specifications

Medium	Compressed air
Pressure range	0.8 - 1.5 bar
Connection thread	G1/8", DIN ISO228
Material	Plastic PEPT
Colour	black
Hose connection	6 mm (0.24 inch)
Weight	370 g (0.8 lbs)
Dimensions	120 x 150 mm (LxW) (4.7 x 5.9 inch (LxW))

Part no.: 801281

Mounting device with air flushing to support and preventive cleaning of the detector optics of flame detectors FMX3511.

Included in delivery

1 Mounting device console 125x80 Ø60 LSP	801298
2 Countersunk screw DIN923-M5x10 St	835703
5 Self-taping screw DIN7981 C4.2x16	885080
5 Blind rivet 3.2x16 alu	885078
1 O-ring 60x3 Viton 70°SH	800774
2 Hex screw DIN933-M8x20-A2	772552
2 Spring washer DIN127 B8-1.4310	820707

Not included in delivery

Adhesive Loctite AVX 586, 50 ml	886226
Hose 6x4 PUN	914329
Hose 6x4 PUN ANTISTAT (Ex)	919559

Air flushing has to be supplied with compressed air on site

Note

Do not install the mounting device console in explosion-hazard zone 1



Industrial detectors

Detector accessories

Mounting device bracket with insulation

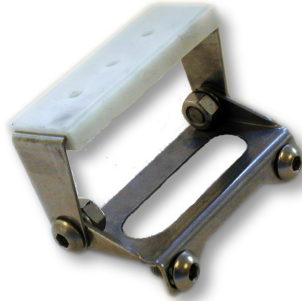

Part no.: 801284

Mounting device to support gas emission detectors, flame detectors, spark detectors and spark test light detectors.

Included in delivery

1 Mounting device complete with 2 oval-head screw M8x12 for fixing the detector on the bracket

Not included in delivery

Clamping screw for wall/ceiling mounting

Technical specifications

Material bracket	Stainless steel, 2 mm (0.08 inch) thick
Material clamp	Stainless steel, 1.5 mm (0.06 inch) thick
Insulating	Plastic POM
Weight	160 g (0.4 lbs)
Dimensions	81.5 x 86 x 31 mm (LxWxH) (3.2 x 3.4 x 1.2 inch (LxWxH))

Spare parts

Oval-head screw M8x12-1.4301	800596
Hex. nut DIN934-M8-A2/A4	820781
Spring washer DIN127 B8-1.4310	820707



Industrial detectors

Detector accessories

Set disk mounting 90 °C (194 °F)

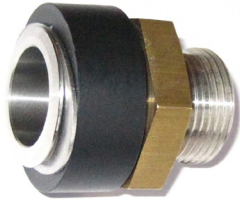

Part no.: 891848

Quick installation device to support detectors with single-hole. The installation is allowed up to a wall thickness of 8 mm (0.3 inch).

Technical specifications

Enclosure material	Stainless steel
- mounting coupling	Brass
- hex. nut	Stainless steel
- oval washer	Polyamide PA12, black
- tapered block	
Operating temperature	to +90 °C (+194 °F)
Weight	120 g (0.3 lbs)

Set disk mounting 250 °C (482 °F)

Part no.: 800034

Quick installation device to support detectors with single-hole and fiber options

Technical specifications

Enclosure material	Peck / Mod, black
tapered block 250 °C (482 °F)	
Operating temperature	to +250 °C (+482 °F)

Otherwise like part no. 891848

Flushing air device



Part no.: 907822

Quick installation device to support detectors with single-hole and air flushing

Not included in delivery

Hose 6x4 PUN	914329
Hose 6x4 PUN ANTISTAT (Ex)	919559

Technical specifications

Enclosure material	V2A and PA 12
Operating temperature	-10 °C to +60 °C (-14 °F to +140 °F)
Operating pressure	0.2 to 10 bar
Hose connection	6 mm (0.24 inch)
Weight	200 g (0.4 lbs)
Dimensions	55 x 48 mm (DxL) 2.2 x 1.9 inch (DxL)



Industrial detectors

Detector accessories

Mounting tool disk mounting - F180

Part no.: 843474



Technical specifications

Enclosure material	Stainless spring band steel
Weight	90 g (0.2 lbs)



Industrial detectors

Flame detector accessories

Sun screen FMX3511/FMX3501 Ex



Part no.: 801277

Protection against unwanted radiation (e.g. sunlight of outdoor applications) for the flame detector FMX3511 and FMX3501 Ex.

Connection / mounting

Plug sun screen onto detector optic.

Note

After mounting the sunscreen can not be removed

Technical specifications

Material	Stainless steel, 2.5 mm (0.09 inch) thick
Dimensions	62.5 x 53 mm (WxH) 2.5 x 2.1 inch (WxH)
Colour	internally black
Weight	90 g (0.2 lbs)

Cleaning kit optic



Part no.: 916644

To clean the optic and reflective surface of flame detectors.

Included in delivery

1 packaging unit
(20 cleaning cloth and 10 cleaning sponge)



Industrial detectors

Thermal detectors - Accessories

Split cable gland QVT 32

Part no.: 934325



Panel feed-through for the flexible sensor rod of UniVario WMX5000 FS Flex detectors.

Included in delivery

Split cable gland QVT (PU 10 pcs.)
Locknut
Ring seal

Product features

- Halogen and silicone-free

Technical specifications

Thread	M32 x 1.5
IP rating	IP54
Fire class	UL94-V0, self-extinguishing
Ambient temperature	-30 °C to +100 °C (-22 °F to +212 °F) (static)
Material	Polycarbonate
Color	grey (similar to RAL 7035)
Weight	220 g (0.49 lbs)
Dimensions	39 x 27 mm (DxH) 1.54 x 1.06 inch (DxH)



Industrial detectors

UniVario Test equipment

Laser measure tool Bosch GLM50-27 C



Part no.: 4003599

Laser measure tool for testing the range and the exact alignment of fire detectors in combination with the UniVario Test-Set JMX5000, part no. 4003558.

Product features

- User-friendly user interface with illuminated color display
Tilt measurement 0 - 360 ° (4 x 90 °)
- Shock absorbing enclosure with rubber coating
- Drop resistance up to 1.5 meters
- Acoustic and vibration signal on successful measurement

Included in delivery

Laser measure tool Bosch GLM50-27 C
Alkaline batteries
Carrying loop
Protection bag

Not included in delivery

UniVario Test-Set JMX5000

4003558

Technical specifications

Measuring range	0.05 - 50 m (1.97 - 164 ft)
Laser diode	635 nm, <1 mW
Laser class	2
Laser color	rot
Measurement precision, typ.	±1.5 mm
Measurement time, typ.	< 0.5 s
Measurement time, max.	4 s
Memory values	30
Power supply	2 x 1.5 V LR6 (AA) Alkaline batteries
Automatic switch off	5 min
IP rating	IP65
Weight	0.2 kg (0.44 lbs)
Dimensions	53 x 119 x 29 mm (WxHxD) 2.09 x 4.69 x 1.14 inch (WxHxD)

Approvals / markings





Industrial detectors UniVario Test equipment

UniVario Test-Set JMX5000



Product features

- Custom-fit adapters for precise alignment of fire detectors

Technical specifications

Ambient temperature	max. +55 °C (+131 °F)
Weight	1.0 kg (2.2 lbs)
Dimensions universal case	265 x 175 x 250 mm (LxWxH) 10.4 x 6.9 x 9.8 inch (LxWxH)

Part no.: 4003558

The UniVario Test-Set JMX5000 allows to check the fault indication visibility and the alignment of the visual range of fire detectors of the types UniVario YMX5000 FMX/FUX single hole, FMX5000 and FMX3511 by darkening the optics of the detectors and using the Laser measure tool Bosch GLM50-27 C, part no. 4003599.

Included in delivery

1 Adapter FMX5000
1 Adapter YMX5000
1 Adapter FMX3511
1 Adapter plate YMX5000
1 Direction part for measure tool
Universal case with adapted foam insert
Short instructions of use

Not included in delivery

Laser measure tool Bosch GLM50-27 C 4003599

Spare parts

See next page.

Note

For the duration of a detector visibility test cycle, a constant obscuration must be maintained by the corresponding adapter.



Industrial detectors UniVario Test equipment

Spare parts UniVario test-set JMX5000

Adapter FMX5000



Part no.: 4003594

Adapter for use with detectors type FMX5000.

Adapter YMX5000



Part no.: 4003595

Adapter for use with detectors type YMX5000.

Adapter FMX3511



Art.-Nr.: 4003596

Adapter for use with detectors type FMX3511.

Adapter plate YMX5000



Part no.: 4003597

Adapter plate for use with detectors type YMX5000.

Direction part Measure tool



Part no.: 4003598

Direction part for the alignment of the Measure tool
Bosch GLM50-27 C, part no. 4003599.



Aspirating smoke detectors

Chapter 08



Aspirating smoke detectors

AMX4004, basic devices

AMX4004



Product features

- Up to three combined sensors can be used for different application areas (scattered light smoke sensor, ionization smoke sensor, carbon monoxide gas sensor)
- High aspiration capacity
- Scattered light smoke sensors for different sensitivity ranges, with pollution compensation for use in critical environments
- Ionization smoke sensor for detecting very small and dark smoke particles
- Carbon monoxide gas sensor for earliest fire detection (40 ppm CO)
- Integrated LC display for indicating status information
- Configurable without accessories (menu-controlled)

Technical specifications

Operating voltage	18 V - 30 V DC
Rated voltage	24 V DC
Measuring principle	dependent on detector heads
Max. current consumption	Detector approx. 400 mA
Max. contact load	60 V DC, 1 A
IP rating	IP 54
Ambient temperature	-20 °C to +50 °C (-4 °F to +122 °F)
Sampling pipe	25 mm (0.98 inch)
Sampling pipe length	max. overall length 100 m (328 ft) max. 50 m (164 ft) as single strand
Relative humidity	max. 95 %, at 35 °C (+95 °F), no condensation
Enclosure material	Die cast aluminum
Cable gland	4 x M16, clamping range 5-9 mm (0.19 - 0.35 inch)
Weight without detector head	3.4 kg (7.5 lbs)
Dimensions without cable gland	280 x 170 x 90 mm (WxHxD) 11.02 x 6.7 x 3.5 inch (WxHxD)
Specification	acc. to EN 54-20, class A, B, C

Part no.: 909244

The aspirating smoke detector AMX4004 is an active smoke detection system that can be individually tuned to the application area with up to three different detector heads. Up to 20 suction holes with a 130 m (427 ft) pipe system are possible thanks to the powerful fan.

Application

Aspirating smoke detector for the detection of smoke particles and/or fire gases in aspirated air samples. The system actively draws air samples from the monitored area via a pipe system.

Typical application areas are:

- Equipment monitoring: computer rooms, warehouses, high rack storage areas, hollow floors.
- protection of cultural assets, transformer stations, etc.

Included in delivery

1 Aspirating smoke detector AMX4004 909244

Not included in delivery

Detector heads:

OMX6002 LS	4002679
approx. 2.73 % /m (0.83 % /ft); approx. 0.120 dB /m	
OMX6002 S	933628
approx. 1.20 % /m (0.10 % /ft); approx. 0.053 dB /m	
OMX6002 HS	933629
approx. 0.34 % /m (0.10 % /ft); approx. 0.015 dB /m	
OMX6002 VHS	933630
approx. 0.12 % /m (0.4 %/ft); approx. 0.005 dB /m	
Ionization smoke detector IMX1002E 1HU, y=0.8	909491
Carbon monoxide gas detector	909492
GMX1002CO 1HU, 40 ppm	

Note

The AMX4004 uses three conventional lines for three alarms as well as one fault line for connection to the fire detection system FMZ 5000 or Clunid. In addition floating contacts for three alarms as well as for fault are available.

Approvals / marking



G 212001



0786-CPD-21095



OPERATING 24/7



Aspirating smoke detectors AMX4004, basic devices



AMX4004 IT AP

Complete device especially for use in IT facilities.
Integrated optical smoke detector OMX6002 HS and optical smoke detector OMX6002 VHS.
Prepared to connect to analogue addressable Loop AP by integrated modul with dual isolator.

Part no.: 921108

Included in delivery

1 Aspirating smoke detector AMX4004	909244
1 Input module IUX 760 M-I	908531
Detector heads:	
1 Optical smoke detector OMX6002 HS	933629
1 Optical smoke detector OMX6002 VHS	933630

Technical specifications

Weight	3.7 kg (8.2 lbs)
--------	------------------

Otherwise like part no.: 909244

AMX4004 WEA

Basic device especially for use in wind turbines
(with integrated controlled heating)

Part no.: 909043

Technical specifications

Max. current consumption	Heating approx. 1.4 A
--------------------------	-----------------------

Otherwise like part no.: 909244



Aspirating smoke detectors

AMX4004, detector heads

Optical smoke detector OMX6002 LS (incl. Adapter OMX6002)



Part no.: 4002679

Technical specifications

Sensitivity	approx. 2.73 % / m (0.83 % / ft)
Weight	0.135 kg (0.3 lbs)
Dimensions	55 x 40 mm (DxH) 2.16 x 1.57 inch (DxH)

Optical smoke detector OMX6002 S (incl. Adapter OMX6002)



Part no.: 933628

Technical specifications

Sensitivity	approx. 1.2 % / m (0.37 % / ft)
Weight	0.135 kg (0.3 lbs)
Dimensions	55 x 40 mm (DxH) 2.16 x 1.57 inch (DxH)

Optical smoke detector OMX6002 HS (incl. Adapter OMX6002)



Part no.: 933629

Technical specifications

Sensitivity	approx. 0.34 % / m (0.10 % / ft)
Weight	0.135 kg (0.3 lbs)
Dimensions	55 x 40 mm (DxH) 2.16 x 1.57 inch (DxH)

Optical smoke detector OMX6002 VHS (incl. Adapter OMX6002)



Part no.: 933630

Technical specifications

Sensitivity	approx. 0.12 % / m (0.04 % / ft)
Weight	0.135 kg (0.3 lbs)
Dimensions	55 x 40 mm (DxH) 2.16 x 1.57 inch (DxH)

Ionization smoke detector IMX1002E 1HU



Part no.: 909491

Technical specifications

Sensitivity	y = 0.8
Weight	0.1 kg (0.22 lbs)
Dimensions	55 x 40 mm (DxH) 2.16 x 1.57 inch (DxH)

Carbon monoxide gas detector GMX1002 CO 1HU



Part no.: 909492

Technical specifications

Trigger value carbon monoxide	40 ppm
Weight	0.05 kg (0.11 lbs)
Dimensions	55 x 40 mm (DxH) 2.16 x 1.57 inch (DxH)



Aspirating smoke detectors

HELIOS AMX5000, basic devices

AMX5001



Product features

- Autolearning function
- Separate airflow monitoring with one or two aspiration lines
- Adjustable sensitivity of 0.002 - 10 % / m (0.0006 - 3.049 % / ft)
- High sampling power (high negative pressure of 400 Pa)
- Highly sensitive smoke sensors with contamination compensation for use in critical environments
- Full integration into fire alarm system FMZ 5000 or Clunid

Technical specifications

Operating voltage	10.5 - 30 V DC
Rated voltage	24 V DC
Alarm sensitivity	0.02 % / m - 10 % / m (0.006 % / ft - 3.049 % / ft)
Pre-Alarm signals 1,2,3	0.002 - 10 % / m (0.0006 % / ft - 3.049 % / ft, programmable in increments of 10 %
Max. current consumption	Inactive/fault approx. 340 mA Alarm I approx. 390 mA
Number of relays	3
Max. contact load	50 V DC, 1 A
IP rating	IP 54
Ambient temperature	-30 °C to +60 °C (-22 °F to +140 °F)
Intake pressure	> 400 Pa (power level 5)
Suction noise at fan level 3 (standard)	43 dB (A)
Number of installation spaces for add-on modules	4
Sampling pipe	Plug-in system 25 mm (0.98 inch) max. 95 %, temporarily without condensation
Relative humidity	70 %, constantly
Enclosure material	ABS-Blend, UL 94-V0
Specification according to	EN 54-20, classes A, B and C
Weight	3.85 kg (8.5 lbs)
Dimensions	265 x 397 x 146 mm (WxHxD) 10.4 x 15.6 x 5.8 inch (WxHxD)

Part no.: 908095

The HELIOS AMX5000 aspirating smoke detector is a highly sensitive active smoke detection system of the latest generation. In addition to monitoring advance signals and contamination, it also provides the option of the user-specific adjustment of the sensitivity. The powerful fan enables up to 50 sampling holes with 300 m (984 ft) pipe system per smoke sensor. The HELIOS AMX5000 is even able to detect the smallest smoldering fires and can be used practically everywhere. Version AMX5001: basic device with simple display. For 1 sampling pipe and 1 smoke sensor.

Application

Aspirating smoke detector for the detection of smoke particles by air sampling. The system takes on air sampling probe in from the monitoring area via a pipe system.

Typical applications

- Equipment monitoring:
IT systems, electrical distributors, switch cabinets, etc.
- Room monitoring: IT rooms, clean rooms, warehouses, high rack storage areas, hollow floors, protection of cultural assets, transformer stations, etc.

Included in delivery

1 Aspirating smoke detector AMX5001 908095

Not included in delivery

Smoke sensor OMX5005,
0.5 % / m - 10 % / m (0.152 % / ft - 3.049 % / ft) 908099
Smoke sensor OMX5010,
0.1 % / m - 10 % / m (0.030 % / ft - 3.049 % / ft) 908100
Smoke sensor OMX5020,
0.02 % / m - 10 % / m (0.006 % / ft - 3.049 % / ft) 908101
Relay module KMX5005 RK 908103
Memory module MMX5005 908104
Configuration software HELIOS Config 908105
Project planning software HELIOS PipeCalc 908106

Spare parts

Case fastener (4 pieces) 909434
Air flow sensor HELIOS AMX5000 917702

Note

The HELIOS AMX5000 can be connected to a higher-level fire alarm panel via dry changeover contacts. The HELIOS AMX5000 can be integrated into a fire detection system FMZ 5000 or Clunid with Loop AP via modules. Indication and operation are thus possible at the control panel.

Approvals / marking



G 208193



0786-CPD-20637





Aspirating smoke detectors HELIOS AMX5000, basic devices



AMX5002

Part no.: 908096

Basic device with simple display.
For 2 aspiration tubes and 2 smoke sensors.

Technical specifications

Max. current consumption	Inactive/fault approx. 380 mA Alarm I approx. 450 mA
--------------------------	---

AMX5101

Part no.: 908097

Basic device with 10-LED display.
For 1 aspiration tube and 1 smoke sensor.

Technical specifications

Max. current consumption	Inactive/fault approx. 340 mA Alarm I approx. 405 mA
--------------------------	---

AMX5102

Part no.: 908098

Basic device with 10-LED display.
For 2 aspiration tubes and 2 smoke sensors.

Technical specifications

Max. current consumption	Inactive/fault approx. 380 mA Alarm I approx. 490 mA
--------------------------	---



Aspirating smoke detectors HELIOS AMX5000, detector heads

Smoke sensor OMX5005



Part no.: 908099

Technical specifications

Sensitivity	0.5 % / m - 10 % / m (0.152 % / ft - 3.049 % / ft)
Weight	0.30 kg (0.66 lbs)
Dimensions	150 x 125 x 95 mm (WxHxD) 5.90 x 4.92 x 3.74 inch (WxHxD)

Smoke sensor OMX5010



Part no.: 908100

Technical specifications

Sensitivity	0.1 % / m - 10 % / m (0.030 % / ft - 3.049 % / ft)
Weight	0.30 kg (0.66 lbs)
Dimensions	150 x 125 x 95 mm (WxHxD) 5.90 x 4.92 x 3.74 inch (WxHxD)

Smoke sensor OMX5020



Part no.: 908101

Technical specifications

Sensitivity	0.02 % / m - 10 % / m (0.006 % / ft - 3.049 % / ft)
Weight	0.30 kg (0.66 lbs)
Dimensions	150 x 125 x 95 mm (WxHxD) 5.90 x 4.92 x 3.74 inch (WxHxD)



Aspirating smoke detectors

HELIOS AMX5000, detector heads

Detector interface AMX1002 IF



Part no.: 908102

Detector can be used to insert up to two detector heads. Detection of pre-alarm and main alarm via the HELIOS AMX5000.

Technical specifications

Weight	0.26 kg (0.56 lbs)
Dimensions	150 x 115 x 95 mm (WxHxD) 5.90 x 4.52 x 3.74 inch (WxHxD)

Optical smoke detector OMX1002 C



Part no.: 801226

Detector head for use in the HELIOS AMX5000 via the detector interface AMX1002 IF

Technical specifications

Sensitivity	2.73 % / m (0.83 % / ft)
Weight	0.07 kg (0.56 lbs)
Dimensions	55 x 55 mm (DxH) 2.16 x 2.16 inch (DxH)

Optical smoke detector OMX1002C HS



Part no.: 904639

Detector head with increased sensitivity for use in the HELIOS AMX5000 via the detector interface AMX1002 IF

Technical specifications

Sensitivity	0.34 % / m (0.10 % / ft)
Weight	0.07 kg (0.56 lbs)
Dimensions	55 x 55 mm (DxH) 2.16 x 2.16 inch (DxH)

Ionization smoke detector IMX1002E



Part no.: 797144

Technical specifications

Sensitivity	$\gamma = 0,8$
Weight	0.06 kg (0.13 lbs)
Dimensions	55 x 55 mm (DxH) 2.16 x 2.16 inch (DxH)

Carbon monoxide gas detector GMX1002 CO



Part no.: 900959

Technical specifications

Trigger value carbon monoxide	40 ppm
Weight	0.06 kg (0.13 lbs)
Dimensions	55 x 35 mm (DxH) 2.16 x 1.37 inch (DxH)



Aspirating smoke detectors

Fittings

Cable Connection Unit WCU 535 PC

Part no.: 4002124



For use in the suction lines of AMX5001, AMX5002, AMX5101 and AMX5102 aspirating smoke detectors in deep-freeze applications down to -30°C.

Included in delivery

- 1 Cable Connection Unit WCU 535 PC
- 2 Connection gland M32 for suction line
- 1 Connection gland M20 for installation cable

Not included in delivery

- Installation cable
- Wire silicone white 908733
- Wire silicone black 908732

Product features

- For professional connection of the silicone wires for the aspiration fitting sets (heaters)
- The connection between aspirating smoke detector and cable connection unit WCU 535 PC is made by means of installation / fire alarm cable

Approvals / marking



G 208154 0786-CPR-20600

Technical specifications

Material enclosure	Polycarbonate
Color	grey, RAL7035
Ambient temperature	-30 °C to +60 °C (-22 °F to +140 °F)
Specification accord. to	EN 54-20
Weight	0.8 kg (1.76 lbs)
Dimensions without glands	82 x 80 x 85 mm (WxHxD) 3.3 x 3.2 x 3.4 inch (WxHxD)
Dimensions with glands	112 x 150 x 85 mm (WxHxD) 4.4 x 5.9 x 3.4 inch (WxHxD)



Aspirating smoke detectors

HELIOS AMX5004C

AMX5004C



Product features

- Airflow monitoring
- Adjustable sensitivity of 0.006 - 10 % / m (0.0018 - 3.049 % / ft)
- Highly sensitive smoke sensors with contamination compensation for use in critical environments

Technical specifications

Operating voltage	14 - 30 V DC
Rated voltage	24 V DC
Alarm sensitivity	0.02 % / m - 10 % / m (0.006 % / ft - 3.049 % / ft)
Pre-Alarm signals 1,2,3	4 (3 pre signals fix adjusted) 30 / 50 / 70 %
Max. current consumption	75 mA
Number of relays	2 (1 alarm, 1 fault)
Max. contact load	50 V DC, 1 A (UL 30 V DC)
IP rating	IP 54
Ambient temperature	-10 °C to +55 °C (VdS) (14 °F to +131 °F) (VdS) -10 °C to +40 °C (UL) (14 °F to 104 °F) (UL)
Intake pressure	> 30 Pa
Suction noise at fan level 1	< 25 dB (A)
Number of installation spaces for add-on modules	1 Relay interface module HELIOS AMX5004C
Sampling pipe	Plug-in system 25 mm (0.98 inch)
Relative humidity	max. 95 % no condensation
Enclosure material	ABS-Blend, UL 94-V0
Specification according to	UL 268, EN 54-20
Weight	1950 g (4.3 lbs)
Dimensions	195 x 290 x 140 mm (WxHxD) 7.7 x 11.4 x 5.5 inch (WxHxD)

Part no.: 923277

The HELIOS AMX5004C aspirating smoke detector is a highly sensitive active smoke detection system of the latest generation. In addition to monitoring advance signals and contamination, it also provides the option of the user-specific adjustment of the sensitivity. The powerful fan enables up to 12 sampling holes with 75 m (246 ft) pipe system per smoke sensor. The HELIOS AMX5004C is even able to detect the smallest smoldering fires and can be used practically everywhere.

Application

Aspirating smoke detector for the detection of smoke particles in aspirated air samples. The system actively takes air samplings in from the monitored area via a pipe system.

Typical applications:

- Equipment monitoring: IT systems, electrical distributors, switch cabinets, etc.
- Room monitoring: IT rooms, clean rooms, warehouses, hollow floors, protection of cultural assets, transformer stations, etc.

Included in delivery

1 Aspirating smoke detector AMX5004C with smoke sensor OMX5020S

Not included in delivery

Memory card SD HELIOS AMX5004C 925156
Relay-interface module KMX5006RK 924106

Spare parts

Smoke sensor OMX5020S 924107
Air flow sensor AFS 32 925155

Note

The HELIOS AMX5004C can be connected to a higher-level fire detection panel via potential-free changeover contacts. The HELIOS AMX5004C can be integrated into a fire detection system with Loop AP via modules. Indication and operation are thus possible at the panel.

Approvals / marking



G 217082



Aspirating smoke detectors HELIOS AMX5000, accessories

Accessories HELIOS AMX5x01 US

Part no.: 910977

For use with aspirating smoke detector HELIOS AMX5001 and AMX5101 (1 aspiration tube) for „CPVC“ tubes.



Included in delivery

- 1 PVC pipe 25 x 1,5
- 1 Flexible hose
- 3 Adapter M20 x 1,5 - NPT 1/2"
- 1 Adapter M25 x 1,5 - NPT 3/4"

Accessories HELIOS AMX5x02 US

Part no.: 911660

For use with aspirating smoke detector HELIOS AMX5002 and AMX5102 (2 aspiration tubes) for „CPVC“ tubes.

Otherwise like part no.: 910977

Included in delivery

- 2 PVC pipes 25 x 1,5
- 1 Flexible hose
- 3 Adapter M20 x 1,5 - NPT 1/2"
- 1 Adapter M25 x 1,5 - NPT 3/4"



Aspirating smoke detectors

Vesda laser, basic devices

LaserFocus VLF-250



Product features

- Two-level air filtering
- AutoLearn alarm thresholds and air flow rate
- Ultrasonic airflow rate reading
- Laser-based, absolute smoke identification
- Programmable alarm threshold values
- Pre-set pipe network constructions
- Installation and start-up can be carried out in delivered condition

Technical specifications

Sensitivity range	0.025 - 20 %/m (39 inch)
Ambient temperature	0 °C to +40 °C (32 °F to +104 °F)
Temperature of the aspirated air	0 °C to +40 °C (32 °F to +104 °F)
Operating voltage	18 - 30 V DC
Rated voltage	24 V DC
Quiescent current	220 mA
Alarm current	295 mA
Rated output	5.2 W
Rated output for alarm	7.0 W
Areas of coverage	max. 250 m ² (2691 square foot)
IP rating	IP 30
Maximum pipe length	1 x 25 m (984 inch), 2 x 15 m (590 inch)
Event memory	max. 18000 entries
Aspiration tube	Plug-in system 25 mm (0.98 inch)
Relative humidity	5 - 95 %, no condensation
Colour of enclosure	light grey
Specification according to	EN 54-20
Weight	2.0 kg (4.4 lbs)
Dimensions	255 x 185 x 90 mm (WxHxD) 8.9 x 7.3 x 3.5 inch (WxHxD)

Part no.: 908495

The LaserFocus VLF-250 is designed to ensure extremely early smoke detection for small and operationally critical areas. The detector constantly takes air samples through inlets to a pipe network where the air is filtered and sent to a collection chamber. Using light dispersion technology, the presence of even the smallest amounts of smoke can be identified. An immediate airflow rate measuring value display on the air inlet pipe presents the ultrasound airflow rate reading. The system is resistant to changes in air temperature and air pressure and is not damaged by impurities.

Included in delivery

1 LaserFocus VLF-250

Not included in delivery

Mounting hardware

Approvals / marking



G 205060



0832-CPD-0771





Aspirating smoke detectors

Sampling pipes

Pipe 25 x 1.5 mm (98 x 0.06 inch)



Part no.: 905253

Technical specifications

Material	PVC pressure pipe, grey, 10 bar
Weight	1.0 kg (2.2 lbs)
Length	5000 mm (196.9 inch)

Sleeve 25 mm (98 inch)



Part no.: 905264

Technical specifications

Material	PVC, grey, 16 bar
Weight	0.01 kg (0.02 lbs)

Adhesive cap 25 mm (98 inch)



Part no.: 905263

Technical specifications

Material	PVC, grey, 16 bar
Weight	0.01 kg (0.02 lbs)

Elbow 90° 25 x 15 mm (98 x 0.59 inch)



Part no.: 905255

Technical specifications

Material	PVC, grey, 16 bar
Weight	0.03 kg (0.07 lbs)

Bend 90° 25 x 50 mm (98 x 1.97 inch)



Part no.: 905254

Technical specifications

Material	PVC, grey, 16 bar
Weight	0.05 kg (0.1 lbs)

Elbow 45° 25 x 6 mm (98 x 0.23 inch)



Part no.: 905256

Technical specifications

Material	PVC, grey, 16 bar
Weight	0.03 kg (0.07 lbs)

T-piece 90° 3 x 25 mm (0.11 x 98 inch)



Part no.: 905262

Technical specifications

Material	PVC, grey, 16 bar
Weight	0.041 kg (0.09 lbs)



Aspirating smoke detectors

Sampling pipes

Coupling 25 mm (98 inch)



Part no.: 905265

Technical specifications

Material	PVC, grey, 16 bar
Weight	0.06 kg (0.1 lbs)

Hose piece for active detector



Part no.: 904393

Technical specifications

Material	PVC hose with steel reel
Weight	0.15 kg (0.33 lbs)
Length	350 mm (0.3 inch)

Hose flexible D21 grey

Part no.: 834784

Technical specifications

Material	PVC hose flexible
Weight	2.5 kg (5.5 lbs)
Length	cabl roll to 10 m (394 inch)

Ceiling duct set, PVC, d=21.2



Part no.: 908699

Complete suction set for installation in the PVC sensor pipe system d=25 mm (0.98 inch), e.g. for suspended ceilings, for taking air samples from a room. Length: 0.8 m (31.5 inch).

Air duct set ASD

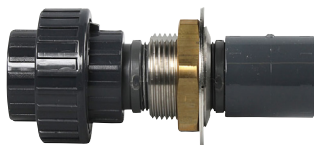

Part no.: 916325

Air duct set ASD for quick and easy installation of the suction-pipe in the air duct.
Application with set disk mounting.

Technical specifications

Material	PVC grey 16 bar Stainless steel/Brass/PA12
Weight	0.29 kg (0.64 lbs)



Aspirating smoke detectors

Aspirating pipes - connections/accessories

Pipe clamp 25 - 28 mm (0.98 - 1.10 inch)

Part no.: 905266



Technical specifications

Material	PP grey
Weight	0.01 kg (0.02 lbs)

Sampling hole clip d=2.0 mm (0.08 inch) red

Part no.: 908331



Sampling hole clip d=2.5 mm (0.09 inch) red

Part no.: 908332

Sampling hole clip d=3.0 mm (0.11 inch) red

Part no.: 908333

Sampling hole clip d=3.5 mm (0.14 inch) red

Part no.: 908334

Sampling hole clip d=4.0 mm (0.16 inch) red

Part no.: 908335

Sampling hole clip d=4.5 mm (0.18 inch) red

Part no.: 908336

Sampling hole clip d=5.0 mm (0.19 inch) red

Part no.: 908337

Sampling hole clip d=5.5 mm (0.22 inch) red

Part no.: 908338

Sampling hole clip d=6.0 mm (0.24 inch) red

Part no.: 908339

Sampling hole clip d=6.5 mm (0.26 inch) red

Part no.: 908340

Sampling hole clip d=7.0 mm (0.28 inch) red

Part no.: 908341

Sampling hole revision red

Part no.: 908342



Aspirating smoke detectors

Aspirating tube system, mounting accessories

Industrial hose, gray 25 m 25/20 mm

Part no.: 4001255



Flexible PVC industrial hose for smoke aspiration with smooth inner and outer surface, reinforced with PVC spirals. For use when laying PVC pipes and sleeves, e.g. to allow flexible laying in the case of joists.

Technical specifications

Material	PVC, gray
Length	25 m (80.02 ft)
Outer diameter	25 mm (0.98 inch)
Inner diameter	20 mm (0.79 inch)
Temperature range	-10 °C to +55 °C (+14 °F to +131 °F)
Permissible operating pressure: at 23 °C (+73 °F) at 55 °C (+131 °F)	7 bar (101.53 psi) 2 bar (29.01 psi)
Bursting pressure: at 23 °C (+73 °F) at 55 °C (+131 °F)	17 bar (246.56 psi) 5 bar (72.52 psi)
Min. bending radius	3 x d
Weight	250 g (0.55 lbs)

Included in delivery

Industrial hose 25 m, coiled bundle

Note

The industrial hose can only be glued in place using a PVC socket and the Adhesive PVC glue UNI-100, part no. 4002970 or 4002971. The use of ABS adhesive or Adhesive PVC glue UNI-100 XT is not permitted.

Approvals / marking





Aspirating smoke detectors

Aspiration tube system, mounting accessories

Adhesive, PVC glue Uni-100



Part no.: 4002971

Technical specifications

Container	500 ml (0.13 gallon) can with brush
Weight	0.8 kg (1.76 lbs)

Adhesive, PVC glue Uni-100



Part no.: 4002970

Technical specifications

Container	125 ml (0.033 gallon) tube
Weight	0.2 kg (0.44 lbs)

Adhesive, PVC glue Uni-100 XT



Part no.: 905267

Technical specifications

Container	500 ml (0.13 gallon) can with brush
Weight	0.8 kg (1.76 lbs)

Note

Must not be used with industrial hose, part no. 4001255.

Adhesive, PVC glue Uni-100 XT



Part no.: 922714

Technical specifications

Container	125 ml (0.033 gallon) tube
Weight	0.2 kg (0.44 lbs)

Note

Must not be used with industrial hose, part no. 4001255.

PVC cleaner



Part no.: 905269

Technical specifications

Container	1000 ml (0.26 gallon) funnel bottle
Weight	1.1 kg (2.42 lbs)



Aspirating smoke detectors Fittings

Pipe cutter plastic pipe + hose



Part no.: 905281

For plastic pipes and hoses of 6 - 35 mm (0,23 to 1.38 inch)

Three-way ball valve, d=25 mm (0.98 inch)



Part no.: 908548

For connecting compressed air to blow the sensor pipework clean

Pipe blow-valve, PVC, automatic



Part no.: 908721

Included in delivery

- 1 PVC sleeve d=40 mm (1.57 inch)
- 1 PVC reducer d=40/25 mm (1.57/0.98 inch)
- 1 Backflow preventer

Compressed-air connection for PVC-DWK d=25 mm (0.98 inch)



Part no.: 908722

Included in delivery

- 1 PVC adapter sleeve
- 1 Brass reducing adapter
- 1 Compressed-air coupling

Sampling fitting set with heater, PVC, red



Part no.: 908723

For creating the pipe system at temperatures down to -30°C (-22 °F)

Included in delivery

- 1 PVC T-piece including heating resistor and suction port d = 5.7 mm (0.22 inch), colour coding: red

Sampling fitting set with heater, PVC, blue



Part no.: 908725

For creating the pipe system at temperatures down to -30°C (-22 °F)

Included in delivery

- 1 PVC T-piece including heating resistor and suction port d = 6.1 mm (0.24 inch), colour coding: blue



Aspirating smoke detectors Fittings

Sampling fitting set with heater, PVC, green



Part no.: 908726

For creating the pipe system at temperatures down to
- 30°C (-22 °F)

Included in delivery

1 PVC T-piece including heating resistor and
suction port d=6.3 mm (0.25 inch), colour coding: green

Sampling fitting set with heater, PVC, black



Part no.: 908728

For creating the pipe system at temperatures down to
- 30°C (-22 °F)

Included in delivery

1 PVC T-piece including heating resistor and
suction port d=6.7 mm (0.26 inch), colour coding: black

Sampling fitting set with heater, PVC, brown



Part no.: 908730

For creating the pipe system at temperatures down to
- 30°C (-22 °F)

Included in delivery

1 PVC T-piece including heating resistor and
suction port d=7.1 mm (0.28 inch), colour coding: brown

Cable connector set, PVC



Part no.: 908731

For creating the pipe system in refrigerated warehouses

Silicone wire, black



Part no.: 908732

For connecting the heaters, single-lead

Included in delivery

1 packaging unit with 100 m (3937 inch)

Silicone wire, white



Part no.: 908733

For connecting the heaters, single-lead

Included in delivery

1 packaging unit with 100 m (3937 inch)



Aspirating smoke detectors Fittings

Filter box (small), d=25 mm (0.98 inch)



Part no.: 908734

For use in rooms with low temperatures and high dust levels

Included in delivery

- 1 Filter box with built-in filter
- 2 Glands

Technical specifications

Enclosure	PVC grey
Temperature range	down to -30 °C (-22 °F)
Dimensions	80 x 82 x 85 mm (HxWxD) 3.2 x 3.2 x 0.8 inch (HxWxD)

Filter box (small)



Part no.: 908740

For use in the filter box (small)

Technical specifications

Temperature range	down to -30 °C (-22 °F)
Dimensions	80 x 80 x 20 mm (HxWxD) 3.2 x 3.2 x 0.8 inch (HxWxD)

Filter box (large) d=25

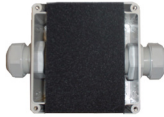

Part no.: 908735

For use in rooms with high dust levels

Included in delivery

- 1 Filter box with filter mat block, fine stage
- 2 Glands

Technical specifications

Enclosure	PVC grey
Temperature range	normal
Dimensions	120 x 122 x 85 mm (HxWxD) 4.7 x 4.8 x 3.4 inch (HxWxD)



Aspirating smoke detectors

Fittings

Filter mat block fine stage



Part no.: 908741

For use in the filter box (large)

Technical specifications

Temperature range	normal
Dimensions	117 x 80 x 80 mm (HxWxD) 4.6 x 3.2 x 3.2 inch (HxWxD)

Filter active detector



Part no.: 900341

Air filter for use aspirating fire detection systems (AMX4004) in case of polluted ambient air

Spare parts

Replacement kit filter active detector 902471
consisting of 1 coarse filter mat, 1 fine filter and
1 Infusion filter 5 µm (for AMX4004 detectors only)

Technical specifications

Enclosure	Polycarbonate, RAL 7035 - light grey
Temperature range	-35 °C to +65 °C (-31 °F to +149 °F)
Relative humidity	max. 98 %, condensation on the filter mats must be ruled out
IP rating (EN 60529)	IP 65
Weight	370 g (0.8 lbs)
Dimensions	122 x 190 x 85 mm (HxWxD) 4.8 x 7.5 x 3.4 inch (HxWxD)

Dust trap box d=25 mm (0.98 inch)



Part no.: 908736

For use in rooms with high dust levels

Included in delivery

1 Dust trap
2 Glands

Technical specifications

Enclosure	PVC grey
Dimensions	240 x 250 x 90 mm (HxWxD) 9.5 x 9.8 x 3.5 inch (HxWxD)



Aspirating smoke detectors

Fittings

Dust separator, cyclone d=25 mm (0.98 inch)



Part no.: 908737

For use in rooms with high dust levels. Smoke and water separator for aspirating smoke detectors. Filterless separation of granular foreign matter with a particle size exceeding 100 µ or liquid aerosols.

Included in delivery

1 Dust and cyclone separator with adapters for installation in sensor pipe systems d = 25 mm (0.98 inch)

Technical specifications

Enclosure	PVC grey
-----------	----------

Automatic blow-out device ADB 01A

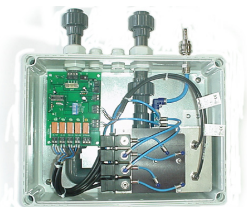

Part no.: 908700

For aspirating smoke detectors for use in rooms with very high dust levels. For the automatic cleaning (blowing out) of the sensor pipe system using compressed air.

Technical specifications

Operating voltage	15 - 30 V DC
Compressed-air port	Constant, approx. 4 bar

Water retaining box, standard



Part no.: 908738

For use with aspirating smoke detectors in rooms with high humidity.

Included in delivery

1 Water retaining box, standard
1 Gland
1 T-piece for connection to the sensor pipe
d = 25 mm (0.98 inch)

Technical specifications

Enclosure	PVC grey
Dimensions	390 x 250 x 90 mm (HxWxD) 15.4 x 9.8 x 3.5 inch (HxWxD)



Aspirating smoke detectors Fittings

Detonation flame arrester



Part no.: 908739

For detection in hazard areas zone 1 (category 2G) and zone 2 (category 3G) in accordance with the Directive 2014/34/EU (ATEX 100a). BAM and TÜV-certified (TÜV = German Inspection Authority) and approved for products of explosion group IIC, up to a permissible standard gap width of ≥ 0.29 mm (1.14 inch). The aspirating smoke detector needs to be mounted outside the potentially explosive area.

Included in delivery

- 1 Explosion and detonation arrester
- 2 Glands

Technical specifications

Enclosure	PVC grey
Dimensions	390 x 250 x 90 mm (HxWxD) 15.4 x 9.8 x 3.5 inch (HxWxD)



Aspirating smoke detectors

OneU®

OneU® active extinguishing system



Product features

- Compact and space-efficient design
- Fire detection and fire fighting by one device directly on and in the protected site
- Expandable by networking with slave extinguishing modules for protecting up to four other sites
- Residue-free extinguishing agent Novec™ 1230 from 3M™
- Minimal maintenance required

Technical specifications

Detection method	2 optical smoke detectors
Rated voltage	100 - 240 V AC, 50/60 Hz
Emergency power supply	approx. 4 h
IP rating	IP 30
Ambient temperature with batteries	+10 °C to +40 °C (Operating) +50 °F to +104 °F (Operating) -20 °C to +65 °C (Storage) -4 °F to +149 °F (Storage)
Humidity	max. 96 %, no condensation
Ports	4 dry changeover contacts Pre-alarm, fire, extinguishing, group fault, for 30 V AC/DC 0.5 A
Display features acc. DIN 14497	1 LCD with text display 1 LED green „Operation“ 1 LED yellow „Shutdown“ 1 LED red „Extinguishing system triggered“ 1 LED red „Extinguishing system released“ 1 LED yellow „Blocked“ 1 LED yellow „Failure“
Aspiration tube	Plug-in system 22 mm (0.86 inch)
Airflow monitoring	approx. +/- 10 % volumetric flow rate, adjustable
Extinguishing agent	approx. 1.8 l Novec™ 1230
Protected volume	max. 2.8 m³ (33 lbs) Cabinet volume
Weight	approx. 15.5 kg (34.2 lbs) with extinguishing agent
Enclosure dimensions	19", 1 U, 660 mm (26 inch) deep

Part no.: 916237

The OneU® active extinguishing system, which is intended for installation in closed switch cabinet systems, is a stand-alone, compact unit that is able to detect and extinguish fires. Novec™ 1230 by 3M™ is used as the extinguishing agent which vaporizes at the discharge nozzle and spreads evenly across the extinguishing zone. This extinguishes the fire by extracting heat energy from the flames. Fire detection occurs by means of 2 fire detectors. Alarms and failures can be transmitted to a superordinate position (monitoring and/or control equipment) via potential-free contacts or via the Monitoring System CMC III (a Rittal product).

The compact system with a space requirement of only 1 height unit is intended for installation in the upper third of the closed switch cabinet system to be protected.

Application / Function

The ideal area of application for the OneU® are spaces with a self-contained atmosphere, as found in server, network, modem and IT cabinets, modem and machine control cabinets, high- and low-voltage cabinets, and telephone distribution cabinets. The smoke aspiration system takes air samples from the entire cabinet volume and conveys them past the two sensitive smoke detectors. When the pre-alarm threshold is reached, shutdown measures can be initiated. If the smoke concentration continues to rise, the extinguishant container is triggered by the fire alarm threshold. The extinguishing agent is discharged, gasified at the discharge nozzle and distributed effectively in the cabinet.

Included in delivery

OneU® active extinguishing system 916237

Not included in delivery

Aspiration tube system 907061

Optional accessories

OneU® ED extinguishing system 916238
LMC III Monitoring system (Rittal)
System SNMP V3

Note

Door contact switches, part no. 889337, with retainers are to be provided by the customer.

OneU® can perform fire detection monitoring for up to five server cabinets, but not selectively. One OneU® active extinguishing system can control up to 4 more extinguishing modules.

Approvals / marking



S 615002



Aspirating smoke detectors

OneU®

OneU® DD aspirating smoke detection system



Product features

- Compact and space-efficient design
- Fire detection directly on and in the protected site
- Expandable by networking with OneU® ED (slave extinguishing system) for protecting up to four other sites
- Easy to mount due to use of international standard 19" technology
- Minimal maintenance required

Technical specifications

Detection method	2 optical smoke detectors
Rated voltage	100 - 240 V AC, 50/60 Hz
Operating voltage	24 V DC
Emergency power supply	approx. 4 h
IP rating	IP 30
Ambient temperature with batteries	+10 °C to +40 °C (Operating) +50 °F to +104 °F (Operating) -20 °C to +65 °C (Storage) -4 °F to +149 °F (Storage)
Humidity	max. 96 %, no condensation
Ports	4 dry changeover contacts Pre-alarm, fire, extinguishing, group fault, for 30 V AC/DC 0.5 A
Display features acc. DIN 14497	1 LCD with text display 1 LED green „Operation“ 1 LED yellow „Shutdown“ 1 LED red „Extinguishing system triggered“ 1 LED red „Extinguishing system released“ 1 LED yellow „Blocked“ 1 LED yellow „Failure“
Aspiration tube	Plug-in system 22 mm (0.86 inch)
Air flow monitoring	approx. +/- 10 % of the total air flow current
Weight	approx. 9.6 kg (21.2 lbs)
Enclosure dimensions	19", 1 U, 490 mm (19.3 inch) deep

Part no.: 916236

The OneU® DD aspirating smoke detection system, which is intended for installation in closed switch cabinet systems, is a stand-alone, compact unit that is able to detect fires. Alarms and failures can be transmitted to a superordinate position (monitoring and/or control equipment) via potential-free contacts or via the Monitoring System CMC III (a Rittal product).

The compact system with a space requirement of only 1 height unit is intended for installation in the upper third of the closed switch cabinet system to be protected.

Application / Function

The ideal area of application for the OneU® are spaces with a self-contained atmosphere, as found in server, network, modem and IT cabinets, modem and machine control cabinets, high- and low-voltage cabinets, and telephone distribution cabinets. The smoke aspiration system takes air samples from the entire cabinet volume and conveys them past the two sensitive smoke detectors. When the pre-alarm threshold is reached, shutdown measures can be initiated. If the smoke concentration continues to rise, the extinguishant container is triggered by the fire alarm threshold. The extinguishing agent is discharged, gasified at the discharge nozzle and distributed effectively in the cabinet.

Included in delivery

OneU® DD aspirating smoke detection system 916236

Not included in delivery

Aspiration tube system 907061

Optional accessories

OneU® ED extinguishing system 916238
LMC III Monitoring system (Rittal)
System SNMP V3

Note

Door contact switches, part no. 889337, with retainers are to be provided by the customer. OneU can perform fire detection monitoring for up to five server cabinets, but not selectively. One OneU® DD can control up to 5 OneU® ED modules.

Approvals / marking



S 615002



Aspirating smoke detectors

OneU®

OneU® ED extinguishing system



Product features

- Compact and space-efficient design
- Fire detection directly on and in the protected site
- Can be expanded by networking with up to 4 OneU® ED extinguishing systems
- Easy to mount due to use of international standard 19" technology
- Minimal maintenance required

Technical specifications

Extinguishing agent	approx. 1.8 l (0.48 gallon) Novec™ 1230
Rated voltage	24 V DC
Operating voltage	24 V DC -3/+5 V
Emergency power supply	approx. 4 h via master device
IP rating	IP 30
Ambient temperature with batteries	+10 °C to +35 °C (Operating) +50 °F to +95 °F (Operating) -20 °C to +65 °C (Storage) -4 °F to +149 °F (Storage)
Humidity	max. 96 %, no condensation
Ports	4 dry changeover contacts Pre-alarm, fire, extinguishing, group fault, for 30 V AC/DC 0.5 A
Display features	exclusive via master device (OneU® or OneU® DD)
Fire detection	via master device
Actuation extinguishing system	via master device
Protected volume	max. 2.8 m³ (33 lbs) Cabinet volume
Weight	approx. 12.5 kg (27.6 lbs) with extinguishing agent
Enclosure dimensions	19", 1 U, 660 mm (26 inch) deep

Part no.: 916238

The OneU® ED extinguishing system, which is intended for installation in closed switch cabinet systems, is a compact unit that is able to extinguish fires. A superordinate system (Active extinguishing system OneU® or aspirating smoke detection system OneU® DD) is to be in place in order to activate this unit. Novec™ 1230 by 3M™ is used as the extinguishing agent which vaporizes at the discharge nozzle and spreads evenly across the extinguishing zone. This extinguishes the fire by extracting heat energy from the flames. Alarms and failures can be transmitted to a superordinate position (monitoring and/or control equipment) via potential-free contacts or via the Monitoring System CMC III (a Rittal product).

The compact system with a space requirement of only 1 height unit is intended for installation in the upper third of the closed switch cabinet system to be protected.

Application / Function

The OneU® ED is part of the OneU® fire protection device series, acting as an additional extinguishing system for expanding the extinguishing capacity by 2.8 m³ (98.9 cubic foot). Smoke detection is always performed by the master device.

Included in delivery

OneU® ED extinguishing system 916238

Optional accessories

OneU® active extinguishing system 916237
OneU® DD aspirating smoke detection system 916236
LMC III Monitoring system (Rittal)
System SNMP V3

Note

Door contact switches, part no. 889337, with retainers are to be provided by the customer.

The OneU® ED can only be operated together with a OneU® active extinguishing system or a OneU® DD, see manual.

Approvals / marking



S 615002



Special detectors

Chapter 09



Special detectors

Linear heat detectors

WMX5000 LH



Product features

- Self-monitoring
- LED status display indicates operation, alarm and fault
- Potential-free contacts signal alarm and fault

Technical specifications

Measuring principle	Linear hear detector cable
Operating voltage	16 - 30 V DC
Current consumption (excluding alarm)	approx. 30 mA
Current consumption (including alarm)	approx. 50 mA
Relay contact alarm max.	1 A / 30 V DC
Relay contact fault max.	1 A / 30 V DC (fail safe)
Normal operation indication	1 LED green
Alarm indication	1 LED red
Fault indication	1 LED yellow
Operating temperature	-40 °C to +80 °C (-40 °F to +176 °F)
IP rating (EN60529)	IP 67
Enclosure material	Diecast aluminum
Weight	860 g (1.9 lbs)
Dimensions incl. base	130 x 140 x 36 mm (BxHxT) 5.12 x 5.51 x 1.42 inch (WxHxD)

Part no.: 913705

The fire detection element is the linear heat detection cable, part no. 910558. The WMX5000 LH monitors the heat detection cable and triggers an alarm when a defined temperature is exceeded at any point of the cable. The detector also has various monitoring functions. Alarms and faults are indicated by LED status displays which are available as potential-free contacts.

Included in delivery

WMX5000 LH with mounted base

Not included in delivery

Linear heat detection cable WMX5000 LH 910558

Note

Compatible with all UniVario assembly components.

Approvals / marking





Special detectors

Linear heat detectors

Linear heat detection cable WMX5000 LH



Technical specifications

Length (standard)	7 m (23 ft)
Permanent temperature max.	+ 120 °C (248 °F)
Response temperature	+ 180 °C (356 °F)
Weight	295 g (0.65 lbs)

Part no.: 910558

The linear heat detection cable is the fire detection element of the linear heat detector WMX5000 LH, part no. 913705.

Included in delivery

Linear heat detection cable WMX5000 LH 910558

Not included in delivery

Linear heat detector WMX5000 LH 913705

Note

Alternate lengths and response temperatures can be provided if required. The cable has to be replaced after a fire detection..



Special detectors

Linear heat detectors

Linear heat detector ProReact incl. EOL

Part no.: 4003611



The fire detection element of the detector is the analog sensor cable, part no. 4003605 or 4003606. The Linear heat detector monitors the sensor cable and triggers an alarm when a defined temperature is exceeded any point of the cable. The analog EOL function device enables the control unit to detect open circuits and short circuits in the sensor cable.

Included in delivery

Linear heat detector ProReact, EOL device

Product features

- Analog sensor control unit
- Self-monitoring via EOL device

Not included in delivery

Sensor cable analog PVC 100 m	4003605
Sensor cable analog PVC 500 m	4003606
L-clip stainless steel	4003607
Pipe clip stainless steel	4003608
High Temperature Silicone Sleeves	4003609
Cable tie	4003610

Technical specifications Linear heat detector

Measuring principle	Sensor cable analog
Operating voltage	20 - 30 V DC
Quiescent current	31 mA / 20 V DC
Current consumption (alarm)	85 mA / 20 V DC
Relay contact alarm max.	2 A / 30 V DC
Operation indication	green
Alarm indication	red
Default indication	yellow
Operating temperature	-20 °C to +50 °C (-4 °F to +122 °F)
Relative humidity	
at max. +30 °C (+86 °F)	max. 95%
at max. +50 °C (-122 °F)	max. 75%
IP rating	IP 65
Enclosure	Polycarbonate
Weight	860 g (1.9 lbs)
Dimensions	182 x 180 x 90 mm (WxHxD) 7.17 x 7.07 x 3.54 inch (WxHxD)

Approvals / marking



G 220006





Cable/installation material

Cable/installation material

Sensor cable analog PVC 100



Technical specifications

Material	PVC, red
Outer diameter	4.83 mm (0.19 inch)
Ambient temperature	-40 °C to +125 °C (-40 °F to + 257 °F)
Relative humidity at -40 °C to +40 °C at +40 °C to +125 °C	max. 99% max. 75%
Weight	3.12 kg (6.88 lbs)
Dimensions cable reel	300 x 100 mm (diaxH) 11.81 x 3.94 inch (diaxH)

Part no.: 4003605

PVC-coated analog Sensor cable for use with Pro React line heat detector, Part no. 4003611, for indoor and outdoor use.

Included in delivery

1 Packaging unit (100 m cable reel)

Approvals / marking



Sensor cable analog PVC 500

Technical specifications

Weight	15.6 kg (34.39 lbs)
Dimensions cable reel	430 x 250 mm (diaxH) 16.93 x 9.84 inch (diaxH)

Part no.: 4003606

Otherwise like part no. 4003605.

Included in delivery

1 Packaging unit (500 m cable reel)

L-clip 50 mm stainless steel



Technical specifications

Material	Stainless steel
Ambient temperature	max. 815 °C (+1499 °F)
Weight	0.016 kg (0.04 lbs)
Dimensions	50 x 20 mm (HxW) 1.97 x 0.79 inch (HxW)

Part no.: 4003607

L-clip for fastening Sensor cables.

Included in delivery

1 Packaging unit
(L-clips, High Temperature Silicone Sleeves 100 pcs.)

Not included in delivery

Fastening material

Pipe clip stainless steel



Mounting example with Sensor cable and Silicone sleeve

Technical specifications

Material	Stainless steel
Ambient temperature	max. 815 °C (+1499 °F)
Weight	0.004 kg (0.01 lbs)
Dimensions	22 x 12 mm (HxW) 0.87 x 0.47 inch (HxW)

Part no.: 4003608

Pipe clip for fastening Sensor cables.

Included in delivery

1 Packaging unit
(Pipe clips, High Temperature Silicone Sleeves 100 pcs.)

Not included in delivery

Fastening material



Cable/installation material

Cable/installation material

High Temperature Silicone Sleeves



Part no.: 4003609

Silicone sleeve to protect sensor cables from abrasion, strong pressure or heat transfer, which could affect the functionality of the cable.

Technical specifications

Material	silicone, black
Ambient temperature	max. +180 °C (+356 °F)
Dimensions	25 x 6 mm (Lxdia) 0.98 x 0.24 inch (Lxdia)
Weight	0.001 kg

Included in delivery

1 Packaging unit (100 pcs.)

Cable tie 102x2,5 mm PA66 sw 110 °C

Technical specifications

Ambient temperature	max. +110 °C (+230 °F)
Dimensions	102 x 2.5 mm (LxW) 4.02 x 0.1 inch (LxW)
Weight	0.001 kg

Part no.: 4003610

UV light and heat resistant cable tie for fixing sensor cables.

Included in delivery

1 Packaging unit (100 pcs.)

Push-in plug clamp 6 mm

Technical specifications

Length dowel	30 mm
Borehole	6 mm
Material	PP Hostalen, transparent matt
Weight	0.003 kg

Part no.: 931500

Push-in plug clamp with integrated dowel for fastening sensor cables Ø 3 - 5 mm with optimum spacing of the cable to ceiling or wall.

Included in delivery

1 Packaging unit (100 pcs.)



Special detectors

Linear smoke detectors

FireRay 5000



Product features

- Integrated laser
- One system controller unit can be used to control and monitor up to two detector heads
- Monitored area min. 8 m (25 ft) up to max. 100 m (328 ft) depends on the used number of prism reflectors
- Auto-Align: automatic ray alignment
- Auto-Optimize: adjustment to compensate for building movement and impurities
- 2-wire interface between system control device and detector
- Integrated event log for 50 events per detector head

Technical specifications

Optical wavelength	850 nm
Ambient temperature	-10 °C to +55 °C (+14 °F to +131 °F)
Storage temperature	-40 °C to +85 °C (-40 °F to +185 °F)
Relative humidity	max. 93 %, no condensation
Operating voltage	14 to 36 V DC
Rated voltage	24 V DC
Rated current consumption with 1 detector head	5 to 6 mA
Rated current consumption with 2 detector heads	7.5 to 8.5 mA
Current consumption alignment mode	35 to 37 mA
Outputs	2 alarm relays 2 fault relays
Relay contact voltage	30 V DC
Relay contact current	100 mA
Response sensitivity	adjustable 10 to 60 %
IP rating	IP 54
Specification according to	EN 54-12
Weight (system control)	1000 g (2.2 lbs)
Dimensions (system control)	202 x 230 x 87 mm (WxHxD) 7.95 x 9.05 x 3.42 inch (WxHxD)
Weight (detector head)	500 g (1.1 lbs)
Dimensions detector head	134 x 131 x 134 mm (WxHxD) 5.27 x 5.16 x 5.27 inch (WxHxD)
Dimensions prism reflectors	100 x 100 x 10 mm (WxHxD) 3.9 x 3.9 x 0.4 inch (WxHxD)

Part no.: 908458

The FireRay 5000 is a motorized, linear smoke detector with automatic alignment and optical rays. The FireRay 5000 consists of an infrared transmitter and an infrared receiver within the same device. It works by conducting a clearly distinguished ray to a reflective prism. If the ray meets smoke, a decrease in performance is recorded and an alarm signal is triggered as when this drops below a pre-programmed threshold. As soon as the laser is used to roughly align the ray, the Auto-Align takes over to move the ray into the optimal position. This is an ideal solution for the protection of wide areas in which the use of standard detector technology would pose significant costs.

Included in delivery

- 1 System controller unit
- 1 Detector head
- 1 Reflector
- 1 Short range mask

Note

1 reflector is monitoring distances from 8 up to 50 m (26 up to 164 ft). For a range less than 18 m (59 ft), the short range mask may be used. 4 reflectors are required for monitoring a range of 50 m up to 100 m (26.25 up to 328 ft).

Approvals / marking



G 208017



2831-CPR-F0390





Special detectors

Linear smoke detectors, accessories

Detector head

Part no.: 908661

Additional detector head with reflector for the Fireray 5000.



Universal mounting bracket

Part no.: 908460

Bracket pivots for accurate alignment of Fireray 5000 smoke detector or reflectors.



Technical specifications

Weight	200 g (0.4 lbs)
Dimensions	135 x 135 x 71 mm (WxHxD) 5.3 x 5.3 x 2.8 inch (WxHxD)

Single reflector alignment adapter

Part no.: 908662

Comes pre-drilled to mount 1 reflector.
Designed to mount on the universal mounting bracket.

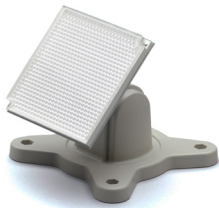

Not included in delivery

Universal holder and reflector.

4 reflectors alignment adapter

Part no.: 908663

Comes pre-drilled to mount 4 reflectors.
Designed to mount on the universal mounting bracket.

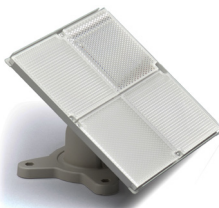

Not included in delivery

Universal holder and reflectors.

Long range reflector kit (3 prisms)

Part no.: 908459

3 additional reflectors for use when the installation is between 50 m / 1968 inch and 100 m / 3937 inch (Fireray 5000) resp. 120 m / 3937 inch (Fireray One) from detector head.

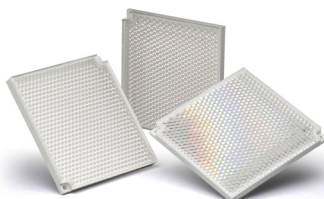

Technical specifications

Weight (1 reflector)	100 g (0.2 lbs)
Dimensions (1 reflector)	100 x 100 x 10 mm (WxHxD) 3.9 x 3.9 x 0.4 inch (WxHxD)



Special detectors

Linear smoke detectors, accessories

Reflector wall bracket

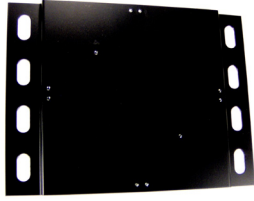
**Part no.: 908664**

Comes pre-drilled to mount 1 (up to 50 m (1968 inch)) or 4 (50 m up to 100 m (1968 to 3937 inch)) reflectors. Hole pattern on side mounting flange similar to unistrut.

Ceiling pendant mount bracket

**Part no.: 908669**

Comes pre-drilled to mount detector head. Can be used for single or bidirectional applications. Includes 2 mounting plates and 1 blank cover.

System controller back box

**Part no.: 908665**

Includes conduit knock-outs on top and bottom. Surface or flush mount. Will mount to single gang, double gang or 4 square box.

Note

Is intended for use on the US market.

System controller semi flush trim plate

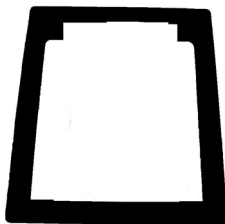
**Part no.: 908666**

Mounts on system controller back box for semi flush installation.

Note

Is intended for use on the US market.

Detector head back box

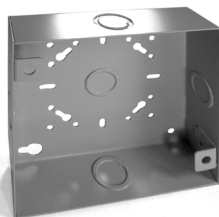
**Part no.: 908667**

Back box includes knock-outs on all four sides. Will mount over single gang, double gang or 4 square box.

Note

Is intended for use on the US market.



Special detectors

Linear smoke detectors, accessories

Detector head cover plate detector head



Part no.: 908668

Use with detector head back box. Pre-drilled to mount the detector head.

Not included in delivery
Flush-mounted enclosure for detector.

Note
Is intended for use on the US market.

Obscuration filter

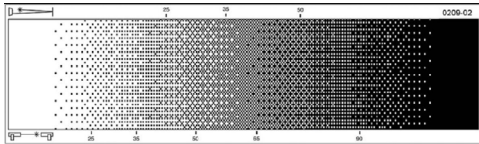

Part no.: 908461

Obscuration test filter to perform the sensitivity test.

Fireray adjustment bracket



Part no.: 4003618

Adjustment bracket for use with Fireray One, Fireray 5000 and Fireray 3000. Provides 360 ° rotation plus max. 180 ° adjustment depending on used detector.

Fireray One heater



Part no.: 4003619

Heater for protection against condensation onto the optics.

Technical specifications

Operating voltage	24 V AC/DC
Current consumption	20 W
Ambient temperature	-10 °C to +43 °C (+14 °F to +109 °F)
Relative humidity	max. 95% no condensation

Fireray One Back box



Part no.: 4003620

Surface-mounted wall housing for use with Fireray One.



Special detectors

Linear smoke detectors, accessories

Fireray One protective cage

Part no.: 4003621

Protective cage for use with Fireray One.





Special detectors

Linear smoke detectors

Fireray One



Product features

- Integrated laser alignment
- Monitored area min. 5 m (25 ft) up to max. 120 m (394 ft) (depends on the used number of prism reflectors)
- Auto-Align: automatic alignment of the ray, no interference between the rays
- Building movement tracking™: adjustment to compensate for building movement
- Insensitive to sunlight
- Easy installation, integrated user interface

Technical specifications

Operating voltage	14 - 36 V DC
Operating current:	
constantly	5 mA
fast alignment mode	33 mA
Optical wavelength	850 nm
Response thresholds 25, 35, 55, 85% ¹⁾	1.87 dB
Response sensitivity	adjustable 25% to 85%
Alarm / fault delay	10 s
Operating temperature	-20 °C to +55 °C (-4 °F to +131 °F)
Storage temperature	-40 °C to +85 °C (-40 °F to +185 °F)
Relative humidity	max. 93 %, no condensation
IP rating	IP 55
Weight (detector head)	700 g (1.54 lbs)
Dimensions (detector head)	130 x 181 x 134 mm (WxHxD) 5.1 x 7.1 x 5.3 inch (WxHxD)
Dimensions (prism reflector)	100 x 100 x 9 mm (WxHxD) 3.9 x 3.9 x 0.4 inch (WxHxD)

¹⁾Only response thresholds 25% and 35% are approved acc. to EN 54-12

Part no.: 4003617

Stand-alone linear smoke detector with automatic alignment, automatic compensation for building movement and sunlight exposure. The Fireray One consists of an transmitter and receiver within the same device and works by conducting a clearly distinguished ray to a reflective prism. If the ray encounters smoke, the decrease of light intensity is recorded and an alarm signal is triggered as when this drops below a predefined threshold. The Fireray One is designed for the protection of e.g. industrial plants, warehouses, aircraft hangars, retail complexes and in the chemical family.

Included in delivery

- 1 Detector base with System control unit
- 1 Detector head
- 1 Reflector
- 1 Short range mask

Note

1 reflector is monitoring distances from 5-50 m (16-164 ft). For a range less than 18 m (59 ft), the short range mask may be used. 4 reflectors are required for monitoring a range of 50-120 m (164-394 ft).

Optional accessories

Fireray adjustable bracket	4003618
Fireray One heater	4003619
Fireray One wall box	4003620
Fireray One Protective Cage	4003621
Long Range Kit Fireray	908459

Approvals / marking



G 218070



0832-CPR-F2237

Fireray One UL

Approvals / marking



Part no.: 4003626

Base device with 1 reflector for up to 50 m (164 ft) surveillance distance.

Otherwise like part no. 4003617



Special detectors

Optical detection

Duct smoke detector UG-5



Product features

- Automatic alarm threshold tracking
- Single tube air sampler system (Venturi tube)
- Service alarm
- Electronic airflow indicator
- Easy mounting by bayonet fitting
- Test port in housing

Technical specifications

Voltage supply	24 V AC/DC -15%, +10% Not sensitive for polarization
Current consumption	max. 220 mA
Relay output	potential-free
Relay (potential-free), switch contact:	
smoke alarm (2 pcs.)	
service alarm	250 V/8 A
system fault	
low-flow alarm	
LED smoke detector	
green:	service alarm, contamination
red:	smoke alarm
LED PCB	
green:	normal operation
yellow:	system fault, low-flow
Operating temperature	-10 °C to +55 °C (+14 °F to +32 °F)
Relative humidity	max. 99% no condensation
Duct ventilation power range	1 - 20 m/s
Specification acc. to	EN 54-27
Adapter housing	ABS
IP rating	IP54
Weight	1.1 kg (2.43 lbs)
Dimensions	195 x 241 x 68 mm (LxWxH) 7.68 x 9.49 x 2.68 inch (LxWxH)

Part no.: 4004802

The UG-5 duct smoke detector combines the optical smoke detector with an adapter system whereby tube and housing is designed to ensure the optimum airflow through the smoke detector. It can be installed on any side of a ventilation duct in the positions 0°, 90°, 180° and 270°. Via integrated relay contacts for alarm, service alarm, system error and airflow malfunction the message is sent to the connected fire alarm control panel. A service alarm is triggered by the event of contamination.

Included in delivery

Optical Duct smoke detector UG-5

Not included in delivery

Venturi tube	0.6 m	4004803
	1.5 m	4004804
	2.8 m	4004805
Mounting bracket UG-5-AFR		4004808

Optional accessories

Extension Venturi tube	4004806
Smoke detector UG-5 spare part	4004807
Waterproof housing UG-5	4004809

Approvals / marking

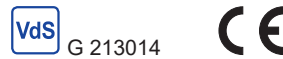



Special detectors

Cyclone monitoring

VMX 3001-S VMX 3001-E

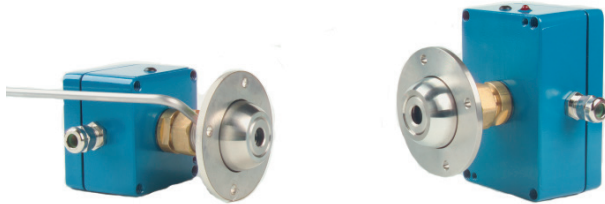

Product features

- Unproblematic alignment of the detectors by means of a spherical joint

Technical specifications

Detection method	Infrared light barrier according to the transmitted light method
Viewing angle	60 ° in case of air flushing
Spectral sensitivity	950 nm
Operating voltage	24 V DC (VMX 3001-S) 7.6-13.2 V DC (VMX 3001-E)
Alarm current consumption	25 mA (VMX 3001-S) approx. 18 mA (VMX 3001-E)
Alarm indication	1 LED red
Electrostatic shielding	required
Operating temperature	-20 °C to +70 °C (-4 °F to +158 °F)
IP rating (EN 60529)	IP 65
Enclosure material	Diecast aluminium, RAL 5009, blue
Relative humidity	max. 95 % at 35 °C (+95 °F) no condensation
Weight	650 g (1.4 lbs) VMX 3001-S 900 g (2 lbs) VMX 3001-E
Dimensions	80 x 75 x 57 mm (WxHxD) 3.2 x 3 x 2.2 inch (WxHxD) VMX 3001-S
	125 x 80 x 57 mm (WxHxD) 4.9 x 3.2 x 2.2 inch (WxHxD) VMX 3001-E

Part no.: 903121

Part no.: 903122

In the timber industry and in milling plants, especially in the chipboard industry, frequent clogging of cyclones occurs due to material deposits which result in a sudden emission of material on the clean air side. In order to detect this material accumulation in the initial stage, thus preventing breakdowns and pollutant emissions, special sensors are installed in the conical section of the cyclone. Monitoring occurs according to the light barrier principle with one infrared emitter VMX 3001-S and on the opposite side one receiver VMX 3001-E.

Not included in delivery

Support ball mounting	903123
Fitting tool	843474
Support adapter assembly with washer	891848
Support adapter assembly with washer 250 °C (482 °F)	800034
Air flushing single hole	907822

Connection / mounting

Connection cable standard detector	2-wire
Conductor cross-section	max. 2.5 mm ² (AWG 13)
Recommended cable with shielding braid	606061
LIYCY grey	5x0.5 mm ² (AWG 20)
Cable gland	M16x1.5, brass galv. nickel-plated, EMV

Approvals / marking



G 208191





Special detectors

Cyclone monitoring, Ex

VMX 3001-S Ex Dust VMX 3001-E Ex Dust



Product features

- Easy alignment of the detectors by means of a spherical joint
- For use in Ex zones 20, 21 and 22

Technical specifications

Detection method	Infrared light barrier according to the transmitted light method
Viewing angle	60 ° in case of air flushing
Spectral sensitivity	950 nm
Operating voltage	24 V DC (VMX 3001-S) 7,6-13,2 V DC (VMX 3001-E)
Alarm current consumption	25 mA (VMX 3001-S) approx. 18 mA (VMX 3001-E)
Alarm indication	1 LED red
Electrostatic shielding	required
Operating temperature	-20 °C to +70 °C (-4 °F to +158 °F)
IP rating (EN 60529)	IP 65
Enclosure material	Diecast aluminium, RAL 5009, blue
Relative humidity	max. 95 % at 35 °C (+95 °F) no condensation
Weight	650 g (1.4 lbs) VMX 3001-S 900 g (2 lbs) VMX 3001-E
Dimensions	80 x 75 x 57 mm (WxHxD) 3.2 x 3 x 2.2 inch (WxHxD) VMX 3001-S
	125 x 80 x 57 mm (WxHxD) 4.9 x 3.2 x 2.2 inch (WxHxD) VMX 3001-E

Part no.: 907434

Part no.: 907433

In the timber industry and in milling plants, especially in the chipboard industry, frequent clogging of cyclones occurs due to material deposits which result in a sudden emission of material on the clean air side. In order to detect this material accumulation in the initial stage, thus preventing breakdowns and pollutant emissions, special sensors are installed in the conical section of the cyclone. These detector versions are suitable as category 1D/3D devices for use in areas of the zones 20, 21 and 22 where there is risk of dust explosion.

Not included in delivery

Support ball mounting	903123
Fitting tool	843474
Support adapter assembly with washer	891848
Support adapter assembly with washer 250 °C (482 °F)	800034
Air flushing single hole	907822

Connection / mounting

Connecting cable standard detector	2-wire
Conductor cross-section	max. 2.5 mm ² (AWG 13)
Recommended cable with shielding braid	606061
LIYCY grey	5x0.5 mm ² (AWG 20)
Cable gland	M16x1.5, brass galv. nickel-plated, EMV, Ex

Approvals / marking

Type examination certificate: BVS 09 ATEX E025





Notification devices

Chapter 10



Notification devices

Audible

Sounder ROLP MX



Part no.: 908631

Audible notification device for signaling fire hazards, approved according to EN 54-3 and VdS. The alarm signaling device offers a selection of 32 tones and the configuration is carried out via a five-pin DIP switch. Up to two different acoustic signals can be configured via wiring. The volume can be adjusted via a DIP-switch.

Technical specifications

Enclosure material	ABS, red
IP rating	IP 65
Rated voltage	24 V DC
Operating voltage	9 V - 28 V DC
Rated current consumption	32 mA
Tones	32
Tone stages	2
Ambient temperature	-25 °C to +70 °C (-13 °F to +158 °F)
Relative humidity	max. 95 %
Sound pressure	up to 102 dB (A) 1 m
Weight	250 g (0.6 lbs)
Dimensions	93 x 93 mm (WxH) 3.7 x 3.7 inch (WxH)

Included in delivery

1 Sounder ROLP MX

Not included in delivery

Mounting hardware
Cable glands

Connection / mounting

Recommended cable 2-wire
Conductor cross-section max. 2.5 mm² (AWG 13)

Note

The sounder can only be operated via the via the voltage reversal function at the fire detection and suppression control panels FMZ 5000, FMZ 5000 modS or Clunid. The device has an integrated reverse polarity protection diode.

Approvals / marking



G 206019



0832-CPD-0128





Notification devices

Audible

Sounder PA 1



Part no.: 917456

Audible notification device for signaling fire hazards, approved according to EN 54-3 and VdS. The sounder is impressive due to its safe and simple mounting with external lugs or internal holes, simple electrical connection on the bottom of the casing. A potentiometer can be used to adjust the volume.

Technical specifications

Enclosure material	PC/ABS Blend, red
IP rating	IP 66
Ambient temperature	-40 °C to +55 °C (-40 °F to +131 °F)
Storage temperature	-40 °C to +70 °C (-40 °F to +158 °F)
Relative humidity	max. 90 %
Rated voltage	24 V DC
Operating voltage	10 V - 57 V DC
Rated current consumption ¹⁾	38 mA (at 24 V DC / DIN-tone)
Current consumption max. (acc. to UL)	80 mA
Tones	80
Tone stages	3 additional ext. selectable
Sound level	max. 105 dB (A) 1 m
Weight	270 g (0.59 lbs)
Dimensions	109.5 x 86 x 80.6 mm (WxHxD) 4.3 x 3.4 x 3.2 inch (WxHxD)

¹⁾ The manufacturer's technical documentation exclusively lists the data according to UL specifications. In some cases, these deviate significantly from the values to be expected in reality.

Included in delivery

1 Sounder PA 1

Not included in delivery

Mounting hardware
Cable glands

Connection / mounting

Recommended cable 2-wire
Conductor cross-section max. 2.5 mm² (AWG 13)

Note

The sounder has three pre-cut M20 cable openings. It can only be operated via the voltage reversal function at fire detection and suppression control panels FMZ 5000, FMZ 5000 modS or Clunid. The device has an integrated reverse polarity protection diode.

Approvals / marking



G 212115



0786-CPD-21182





Notification devices

Audible

Sounder PA 5



Part no.: 917457

Audible notification device for signaling fire hazards, approved according to EN 54-3 and VdS. The sounder is impressive due to its safe and simple mounting with external lugs or internal holes, simple electrical connection on the bottom of the casing. A potentiometer can be used to adjust the volume.

Technical specifications

Enclosure material	PC/ABS Blend, red
IP rating	IP 66
Ambient temperature	-40 °C to +55 °C (-40 °F to +131 °F)
Storage temperature	-40 °C to +70 °C (-40 °F to +158 °F)
Relative humidity	max. 90 %
Rated voltage	24 V DC
Operating voltage	10 V - 57 V DC
Rated current consumption ¹⁾	38 mA (at 24 V DC / DIN-tone)
Current consumption max. (acc. to UL)	80 mA
Tones	80
Tone stages	3 additional ext. selectable
Sound level	max. 107 dB (A) 1 m
Weight	643 g (1.41 lbs)
Dimensions	143 x 135 x 132 mm (WxHxD) 5.6 x 5.3 x 5.2 inch (WxHxD)

¹⁾ The manufacturer's technical documentation exclusively lists the data according to UL specifications. In some cases, these deviate significantly from the values to be expected in reality.

Included in delivery

1 Sounder PA 5

Not included in delivery

Mounting hardware
Cable glands

Connection / mounting

Recommended cable 2-wire
Conductor cross-section max. 2.5 mm² (AWG 13)

Note

The sounder has three pre-cut M20 cable openings. It can only be operated via the voltage reversal function at fire detection and suppression control panels FMZ 5000, FMZ 5000 mod S or Clunid. The device has an integrated reverse polarity protection diode.

Approvals / marking



G 212115



0786-CPD-21182





Notification devices

Audible

Sounder PA 10



Part no.: 4004596

Audible notification device for signaling fire hazards, approved according to EN 54-3 and VdS. The sounder is impressive due to its safe and simple mounting with external lugs or internal holes, simple electrical connection on the bottom of the casing. A potentiometer can be used to adjust the volume.

Technical specifications

Enclosure material	PC/ABS Blend, red
IP rating	IP 66
Ambient temperature	-40 °C to +55 °C (-40 °F to +131 °F)
Storage temperature	-40 °C to +70 °C (-40 °F to +158 °F)
Relative humidity	max. 90 %
Rated voltage	24 V DC
Operating voltage	10 V - 60 V DC
Rated current consumption ¹⁾	282 mA (at 24 V DC / DIN-tone)
Current consumption max. (acc. to UL)	485 mA
Tones	80
Tone stages	3 additional ext. selectable
Sound level	max. 117 dB (A) 1 m
Weight	1050 g (2.31 lbs)
Dimensions	214 x 170 x 156 mm (WxHxD) 8.4 x 6.7 x 6.1 inch (WxHxD)

¹⁾ The manufacturer's technical documentation exclusively lists the data according to UL specifications. In some cases, these deviate significantly from the values to be expected in reality.

Included in delivery

1 Sounder PA 10

Not included in delivery

Mounting hardware
Cable glands

Connection / mounting

Recommended cable 2-wire
Conductor cross-section max. 2.5 mm² (AWG 13)

Note

The sounder has seven pre-cut M20 cable openings. It can only be operated via the voltage reversal function at fire detection and suppression control panels FMZ 5000, FMZ 5000 modS or Clunid. The device has an integrated reverse polarity protection diode.

Approvals / marking



G 212191



0786-CPD-21223





Notification devices

Audible

Sounder PA 20

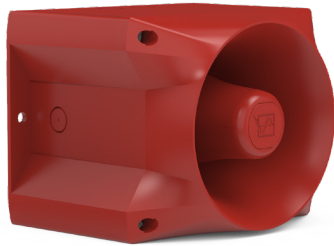

Part no.: 4004597

Audible notification device for signaling fire hazards, approved according to EN 54-3 and VdS. The sounder is impressive due to its safe and simple mounting with external lugs or internal holes, simple electrical connection on the bottom of the casing. A potentiometer can be used to adjust the volume.

Technical specifications

Enclosure material	PC/ABS Blend, red
IP rating	IP 66
Ambient temperature	-40 °C to +55 °C (-40 °F to +131 °F)
Storage temperature	-40 °C to +70 °C (-40 °F to +158 °F)
Relative humidity	max. 90 %
Rated voltage	24 V DC
Operating voltage	10 V - 60 V DC
Rated current consumption ¹⁾	477 mA (at 24 V DC / DIN-tone)
Current consumption max. (acc. to UL)	880 mA
Tones	80
Tone stages	3 additional ext. selectable
Sound level	max. 122 dB (A) 1 m
Weight	1090 g (2.4 lbs)
Dimensions	214 x 170 x 181.2 mm (WxHxD) 8.4 x 6.7 x 7.1 inch (WxHxD)

¹⁾ The manufacturer's technical documentation exclusively lists the data according to UL specifications. In some cases, these deviate significantly from the values to be expected in reality.

Included in delivery

1 Sounder PA 20

Not included in delivery

Mounting hardware
Cable glands

Connection / mounting

Recommended cable 2-wire
Conductor cross-section max. 2.5 mm² (AWG 13)

Note

The sounder has seven pre-cut M20 cable openings. It can only be operated via the voltage reversal function at fire detection and suppression control panels FMZ 5000, FMZ 5000 mod S or Clunid. The device has an integrated reverse polarity protection diode.

Approvals / marking



G 212191



0786-CPD-21223





Notification devices

Audible

Sounder A105N



Part no.: 917458

Audible notification device for signaling fire hazards, approved according to EN 54-3. The sounder is impressive due to its safe and simple mounting with external lugs or internal holes. A potentiometer can be used to adjust the volume.

Technical specifications

Enclosure material	ABS, red
IP rating	IP 66
Ambient temperature	-25 °C to +55 °C (-13 °F to +131 °F)
Storage temperature	-40 °C to +70 °C (-40 °F to +158 °F)
Relative humidity	at 20 °C max. 90 %
Rated voltage	24 V DC
Operating voltage	10 V - 30 V DC
Rated current consumption	at 24 V DC 25 mA
Tones	32
Tone stages	3
Sound pressure	up to 112 dB (A) 1 m
Weight	750 g (1.65 lbs)
Dimensions	144 x 130 x 133.5 mm (WxHxD) 5.7 x 5.1 x 5.2 inch (WxHxD)

Included in delivery

1 Sounder A105N
2 Blanking plugs M 20

Not included in delivery

Mounting hardware
Cable glands

Connection / mounting

Recommended cable 2-wire
Conductor cross-section max. 2.5 mm² (AWG 13)

Note

The sounder has two M20 cable openings. It can only be operated via the voltage reversal function. The device has an integrated reverse polarity protection diode.

Approvals / marking

 0786-CPD-20257



Notification devices

Audible

Sounder Symphoni HO WP



Part no.: 917459

Audible notification device for signaling fire hazards, approved according to EN 54-3 and VdS. A potentiometer can be used to adjust the volume.

Technical specifications

Enclosure material	ABS, red
IP rating	IP 66
Ambient temperature	-25 °C to +70 °C (-13 °F to +158 °F)
Storage temperature	-40 °C to +70 °C (-40 °F to +158 °F)
Relative humidity	max. 90 %
Rated voltage	24 V DC
Operating voltage	18 V - 28 V DC
Rated current consumption	260 mA
Tones	32
Tone stages	2
Sound pressure	up to 120 dB (A) 1 m
Weight	680 g (1.5 lbs)
Dimensions	110 x 110 x 105 mm (WxHxD) 4.3 x 4.3 x 4.1 inch (WxHxD)

Included in delivery

1 Sounder Symphoni HO WP

Not included in delivery

Mounting hardware
Cable glands

Connection / mounting

Recommended cable 2-wire
Conductor cross-section max. 2.5 mm² (AWG 13)

Note

The sounder can only be operated via the voltage reversal function at fire detection and suppression control panels FMZ 5000, FMZ 5000 mod S or Clunid. The device has an integrated reverse polarity protection diode.

Approvals / marking



G 206027



0832-CPD-0142



Notification devices

Audible

Sounder DS10 MX



Part no.: 801175

Audible notification device for signaling fire hazards, approved according to EN 54-3 and VdS. Equipped with an electronic module for operation directly on a primary control group of the fire alarm panel via a voltage increase.

Technical specifications

Enclosure material	Diecast aluminum, red
IP rating	IP 67
Ambient temperature	-25 °C to +55 °C (-13 °F to +131 °F)
Storage temperature	-40 °C to +70 °C (-40 °F to +158 °F)
Relative humidity	max. 90 %
Rated voltage	24 V DC
Operating voltage	19 V - 29 V DC
Rated current consumption	approx. 420 mA
Duty cycle	100 %
Tones	32
Sound pressure	up to 110 dB (A) 1 m
Sound range	approx. 10000 m ² (6.2 miles), Ø 116 m (4567 inch)
Weight	2200 g (4.9 lbs)
Dimensions	134 x 134 x 143 mm (WxHxD) 5.3 x 5.3 x 5.6 inch (WxHxD)

Included in delivery

1 Sounder DS10 MX
1 Cable gland M20 x 1.5
1 Blanking plug M20

Not included in delivery

Mounting hardware

Connection / mounting

Recommended cable 2-wire
Conductor cross-section max. 2.5 mm² (AWG 13)

Note

The sounder can be operated via the voltage increase function as well as via the voltage reversal function at fire detection and suppression control panels FMZ 5000, FMZ 5000 mod S or Clunid. The device has an integrated reverse polarity protection diode.

Approvals / marking



G 204031



0786-CPD-20005





Notification devices

Audible

Sounder DS10 MX ext. tone selection



Product features

- Sounder with external tone selection

Technical specifications

Enclosure material	Diecast aluminium, red
IP rating	IP 67
Ambient temperature	-25 °C to +55 °C (-13 °F to +131 °F)
Storage temperature	-40 °C to +70 °C (-40 °F to +158 °F)
Relative humidity	max. 90 %
Rated voltage	24 V DC
Operating voltage	19 V - 29 V DC
Rated current consumption	approx. 420 mA
Duty cycle	100 %
Tones	32
Sound pressure	up to 110 dB (A) 1 m
Sound range	approx. 10000 m ² (6.2 miles), Ø 116 m (4567 inch)
Weight	2200 g (4.9 lbs)
Dimensions	134 x 134 x 143 mm (WxHxD) 5.3 x 5.3 x 5.6 inch (WxHxD)

Part no.: 801176

Audible notification device for signaling fire hazards, approved according to EN 54-3 and VdS. Equipped with an electronic module for operation directly on a primary control group of the fire alarm panel via a voltage increase.

Included in delivery

- 1 Sounder DS10 MX ext. tone selection
- 1 Cable gland M20 x 1.5
- 1 Blanking plug M20

Not included in delivery

Mounting hardware

Connection / mounting

Recommended cable with function „ext. tone sel.2“
Conductor cross-section

2-wire
3-wire
max. 2.5 mm² (AWG 13)

Note

The sounder can be operated via the voltage increase function as well as via the voltage reversal function at the fire detection and suppression control panels FMZ 5000, FMZ 5000 mod S or Clunid. The device has an integrated reverse polarity protection diode.

Approvals / marking



G 204031



0786-CPD-20005



Notification devices

Audible, addressable

Loop sounder LSX 278r



Part no.: 905805

Loop sounder for audible alarm notification, approved according to EN 54-3 in red colour. Addressing via built-in DIP switches. Choice between two different tones, controlled via the fire alarm panel.

Technical specifications

Material	PC
IP rating	IP 21C
Sound pressure	up to 100 dB
Colour	red
Technology / protocol	Loop AP / XP95
Integrated isolator	no
Ambient temperature	10 °C to +55 °C (+14 °F to +131 °F)
Operating voltage	18 V - 28 V DC
Operating (alarm) current	5 mA
Quiescent current	330 µ A
Weight	290 g (0.6 lbs)
Dimensions	105 x 105 x 90 mm (WxHxD) 4.1 x 4.1 x 3.5 inch (WxHxD)

Included in delivery

1 Loop sounder LSX 278r

Not included in delivery

Mounting hardware

Connection / mounting

Cable recommendation standard
J-Y(St)Y -2x2x0.8 mm, red
Recommended cable
Conductor cross-section
Electrostatic shielding

747180
2-wire
max. 2.5 mm² (AWG 13)
not required

Approvals / marking

 0832-CPD-0147

Loop sounder LSX 279W

Part no.: 905806

Colour white

Otherwise like part no. 905805



Notification devices

Audible, addressable

Loop sounder LSX 274r WP

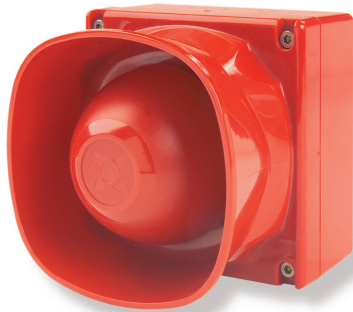

Part no.: 905807

Loop sounder for audible alarm notification, approved according to EN 54-3 in red colour. Addressing via built-in DIP switches. For applications in rough environmental conditions with increased protection rating IP 66. Choice between two different tones, controlled via the fire alarm panel.

Technical specifications

Enclosure material	PC, red
IP rating	IP 66
Colour	red
Technology / protocol	Loop AP / XP95
Integrated isolator	no
Ambient temperature	-20 °C to +70 °C (-4 °F to +158 °F)
Operating voltage	18 V - 28 V DC
Operating (alarm) current	5 mA
Quiescent current	330 µA
Sound pressure	up to 100 dB
Weight	294 g (0.6 lbs)
Dimensions	110 x 110 x 113 mm (WxHxD) 4.3 x 4.3 x 4.5 inch (WxHxD)

Included in delivery

1 Loop sounder LSX 274r

Not included in delivery

Mounting hardware

Connection / mounting

Cable recommendation standard
J-Y(St)Y -2x2x0.8 mm, red
Recommended cable
Conductor cross-section
Electrostatic shielding

747180
2-wire
max. 2.5 mm² (AWG 13)
not required

Approvals / marking

 0832-CPD-0147



Notification devices

Audible, addressable

Loop sounder LSX 001r



Part no.: 916281

Loop sounder for audible alarm notification, approved according to EN 54-3 and VdS with an integrated dual isolator in red colour. Addressing via built-in DIP switches. Choice between two different tones, controlled via the fire alarm panel.

Technical specifications

Material	PC
IP rating	IP 65
Sound pressure	up to 100 dB
Colour	red
Technology / protocol	Loop AP / XP95
Integrated isolator	yes
Tones	3
Ambient temperature	-25 °C to +70 °C (-13 °F to +158 °F)
Operating voltage	17 V - 28 V DC
Operating (alarm) current	5 mA
Quiescent current	333 µA
Weight	225 g (0.5 lbs)
Dimensions	97.5 x 104 mm (dia. xH) 3.8 x 4.1 inch (dia. xH)

Included in delivery

1 Loop sounder LSX 001r

Not included in delivery

Mounting hardware

Connection / mounting

Cable recommendation standard

J-Y(St)Y -2x2x0.8 mm, red

Recommended cable

Conductor cross-section

Electrostatic shielding

747180

2-wire

max. 2.5 mm² (AWG 13)

not required

Approvals / marking



G 212187



0832-CPD-1050

Loop sounder LSX 002w

Part no.: 916282

Colour white

Otherwise like part no. 916281



Notification devices

Audible

Sounder HRK



Product features

- Field-selectable from tone and volume via rotary switch
- Compatible with Synchronization module MDL3R
- For outdoor use

Technical specifications

Enclosure material	PC, red
IP rating	IP 56
IP rating (American NEMA Standard Publ. 250)	NEMA 4X
Rated voltage	24 V DC
Operating voltage	8 - 33 V DC
Rated current consumption	approx. 70 mA depending on sound setting and candela
Tones	3
Operating temperature	-40°C to +66°C (-40 °F to +150.8 °F)
Relative humidity	10 to 93% no condensation
Sound pressure	up to 101 dB
Weight	460 g (1.0 lbs)
Dimensions	119 x 142 x 33 mm (WxHxD) 4.7 x 5.6 x 1.3 inch (WxHxD)

Part no.: 918425

Audible notification device for signaling fire hazards. This sounder is listed for ceiling or wall mounting. Compatible with Synchronization module MDL3R.

Included in delivery

1 Sounder HRK
1 Weatherproof back box

Not included in delivery

Synchronization module MDL3R 931853
Mounting hardware
End of line-resistor and diode

Connecting / mounting

Recommended cable 2-wire
Conductor cross-section max. 3.3 mm² (AWG 12)

Note

Applicable for operation with fire detection and suppression control panel FMZ 5000 mod S CA or Clunid. Distribution only to non-EU countries.

Approvals / marking





Notification devices

Audible

Sounder HRL



Product features

- Field-selectable from tone and volume via rotary switch
- For indoor use
- Impact resistant housing
- Compatible with Synchronization module MDL3R
- Simple installation due to separate mounting plate with integrated short-circuit spring

Technical specifications

Rated voltage	12 V DC 24 V DC
Operating voltage	8 - 17.5 V (12 V) DC 16 - 33 V (24 V) DC
Operating voltage with MDL3 Sync module	8.5 - 17.5 V (12 V) DC 16.5 - 33 V (24 V) DC
Rated current consumption	29-44 mA depending on sound setting and volume level
Tones	4
Volume levels	2
Operating temperature	0°C to +49°C (+32 °F to +120 °F)
Relative humidity	10 to 93% no condensation
Sound pressure	82 - 90 dB
Weight	320 g (0.7 lbs)
Dimensions	119 x 142 x 32 mm (WxHxD) 4.7 x 5.6 x 1.3 inch (WxHxD)

Part no.: 927474

Audible notification device for signaling fire hazards. This sounder is listed for wall mounting in indoor areas. Compatible with Synchronization module MDL3R.

Included in delivery

1 Sounder HRL
1 Mounting plate

Not included in delivery

Synchronization module MDL3R
Mounting hardware
1 End of line-resistor with diode

931853

Connecting / mounting

Recommended cable
Conductor cross-section

2-wire
max. 3.3 mm² (AWG 12)

Note

Distribution only to non-EU countries.

Approvals / marking





Notification devices

Audible, addressable

Base sounder BSX 300



Part no.: 901313

Base sounder for analogue addressable detectors for acoustic alarm generation approved according to EN 54-3 and VdS with dual isolator, in white. Addressing via built-in DIP switch. Simple mounting and easy insertion of detectors by clockwork rotation with subsequent locking. Cover available in red or white for use without detector.

Technical specifications

Enclosure material	Polycarbonate, white
Technology / protocol	Loop AP / XP95 / Discovery
Integrated isolator	yes
IP rating	IP 21D
Relative humidity	0 to 95 % no condensation
Operating temperature	-20 °C to +60 °C (-4 °F to +140 °F)
Operating voltage	17 V - 28 V DC
Rated current consumption	200 µA
Operating pressure	5 mA
Sound pressure	up to 91 dB
Weight	140 g (0.3 lbs)
Dimensions	115 x 38 mm (dia. x H) 4.5 x 1.5 inch (dia. x H)

Included in delivery

1 Base sounder BSX 300
1 Address card

Not included in delivery

Cover base sounder ACX 293 RD 912575
Cover base sounder ACX 292 WH 912576
Mounting plate base sounder ACX 311 4003200

Connection / mounting

Cable recommendation standard
J-Y(St)Y -2x2x0.8 mm, red 747180
Recommended cable 2-wire
Conductor cross-section max. 2.5 mm² (AWG 13)
Electrostatic shielding not required

Approvals / marking



G 207009



2531-CPR-CSP11040

Mounting plate base sounder ACX 311



Part no.: 4003200

Mounting plate for surface mounting of addressable base sounders. The mounting plate enables easy installation of the surface mounted wiring of the base sounder.

Included in delivery

Mounting plate base sounder ACX 311

Not included in delivery

Mounting material

Technical specifications

Material	Polycarbonate, white
Weight	20 g (0.04 lbs)
Dimensions	116.9 x 11.5 mm (dia x D) 4.69 x 0.45 inch (dia x D)



Notification devices

Audible, Ex

Sounder DS10 MX Ex



Product features

- For use in Ex zones 2 and 22

Technical specifications

Enclosure material	Diecast aluminum, red
IP rating	IP 67
Ambient temperature	-25 °C to +55 °C (T4) -13 °F to +131 °F (T4) -25 °C to +60 °C (T3) -13 °F to +140 °F (T3)
Storage temperature	-40 °C to +70 °C -40 °F to +158 °F
Relative humidity	max. 90 %
Rated voltage	24 V DC
Operating voltage	19 V - 29 V DC
Rated current consumption	420 mA
Duty cycle	100 %
Tones	32
Sound pressure	up to 110 dB (A) 1 m approx. 10000 m ² (107639 square foot), Ø 116 m (4566 inch)
Sound range	
Weight	2200 g (4.9 lbs)
Dimensions	134 x 134 x 143 mm (WxHxD) 5.3 x 5.3 x 5.6 inch (WxHxD)

Part no.: 900282

Audible notification device for the signaling of fire hazards, approved according to EN 54-3 and VdS. The sounder is especially suitable for use in industrial environments with hazardous areas in zone 2 as well as 22. Equipped with an electronic module for operation directly on a primary control group of the fire alarm panel via a voltage increase.

Included in delivery

- 1 Sounder DS10 MX Ex
- 1 Cable gland M20 x 1.5
- 1 Blanking plug M20

Not included in delivery

Mounting hardware

Connection / mounting

Recommended cable 2-wire
Conductor cross-section max. 2.5 mm² (AWG 13)

Note

The sounder can be operated via the voltage increase function as well as via the voltage reversal function at the fire detection and suppression control panels FMZ 5000, FMZ 5000 mod S or Clunid. The device has an integrated reverse polarity protection diode.

Approvals / marking

Ex classification: II 3G Ex nAc IIC T4 -25°C ≤ Ta ≤ +55°C
 II 3G Ex nAc IIC T3 -25°C ≤ Ta ≤ +60°C
 II 3D Ex tc IIIB T135°C IP 67 -25°C ≤ Ta ≤ +60°C

Ex conformity Russia in acc. with TP TC 012/2011:
2Ex nA_c IIC T3/T4
Ex tc IIIB T135°C IP 65



G 204031



0786-CPD-20005





Notification devices

Audible, Ex

Sounder DS10 MX Ex, ext. tone selection



Product features

- For use in Ex zones 2 and 22
- Sounder with external tone selection

Technical specifications

Enclosure material	Diecast aluminium, red
IP rating	IP 67
Ambient temperature	-25 °C to +55 °C (T4) -13 °F to +131 °F (T4) -25 °C to +60 °C (T3) -13 °F to +140 °F (T3)
Storage temperature	-40 °C to +70 °C -40 °F to +158 °F
Relative humidity	max. 90 %
Rated voltage	24 V DC
Operating voltage	19 V - 29 V DC
Rated current consumption	approx. 420 mA
Duty cycle	100 %
Tones	32
Sound pressure	up to 110 dB (A) 1 m
Sound range	approx. 10000 m ² (107639 square foot), Ø 116 m (4566 inch)
Weight	2200 g (4.9 lbs)
Dimensions	134 x 134 x 143 mm (WxHxD) 5.3 x 5.3 x 5.6 inch (WxHxD)

Part no.: 900283

Audible notification device for the signaling of fire hazards approved according to EN 54-3 and VdS. The sounder is especially suitable for use in industrial environments with hazard areas in zone 2 as well as 22. Equipped with an electronic module for operation directly on a primary control group of the fire alarm panel via a voltage increase.

Included in delivery

- 1 Sounder DS10 MX Ex, ext. tone selection
- 1 Cable gland M20 x 1.5
- 1 Blanking plug M20

Not included in delivery

Mounting hardware

Connection / mounting

Recommended cable 2-wire
with function „ext. tone sel.“ 3-wire
Conductor cross-section max. 2.5 mm² (AWG 13)

Note

The sounder can be operated via the voltage increase function as well as via the voltage reversal function at the FMZ 5000 and FMZ 5000 mod S control panels. The device has an integrated reverse polarity protection diode.

Approvals / marking

Ex classification: x II 3G Ex nAc IIC T4 -25°C ≤ Ta ≤ +55°C
x II 3G Ex nAc IIC T3 -25°C ≤ Ta ≤ +60°C
x II 3D Ex tc IIIB T135°C IP 67 -25°C ≤ Ta ≤ +60°C



G 204031



0786-CPD-20005





Notification devices

Audible, Ex

Sounder BExS110E MX



Product features

- Explosion-protected device for hazardous zone 1
- Sounder with flameproof enclosure
- Terminal compartment compliant with protection rating "Increased safety Ex e"

Technical specifications

Enclosure material	Diecast aluminium, red
Horn material	ABS, red
IP rating	IP 67
Ambient temperature	Ex de IIC T4 (-50 °C to +55 °C) (-58 °F to +131 °F) Ex de IIB T4 (-50 °C to +70 °C) (-58 °F to +158 °F)
Storage temperature	-50 °C to +70 °C (-58 °F to +158 °F)
Relative humidity	max. 90 %
Rated voltage	24 V DC
Operating voltage	18 V - 30 V DC
Rated current consumption	approx. 265 mA
Duty cycle	100 %
Tones	32
Sound pressure	up to 107.5 dB (A) 1 m
Sound range	approx. 5500 m ² (59201 square foot), Ø 85 m (3346 inch)
Weight	3400 g (7.5 lbs)
Dimensions	181 x 275 mm (dia. x W) 7.1 x 10.8 inch (dia. x W)

Part no.: 900876

Audible notification device for signaling fire hazards. The sounder is especially suitable for use in industrial environments with hazardous areas in zone 1. Equipped with an electronic module for operation directly on a primary control group of the fire alarm panel via a voltage increase.

Included in delivery

1 Sounder BExS110E MX

Not included in delivery

Mounting hardware
Cable glands

Connection / mounting

Recommended cable 2-wire
Conductor cross-section max. 4 mm² (AWG 11)

Note

The sounder can be operated via the voltage increase function as well as via the voltage reversal function at the fire detection and suppression control panels FMZ 5000, FMZ 5000 mod S or Clunid. The device has an integrated reverse polarity protection diode.

Approvals / marking

Ex classification:

II 2G Ex de IIC T4
II 2G Ex de IIB T4





Notification devices

Audible, Ex

Sounder BExS120E MX



Product features

- Explosion-protected device for hazardous zone 1
- Sounder with flameproof enclosure
- Terminal compartment compliant with protection rating "Increased safety Ex e"

Technical specifications

Enclosure material	Diecast aluminium, red
Horn material	ABS, red
IP rating	IP 67
Ambient temperature	Ex de IIC T4 (-50 °C to +55 °C) (-58 °F to +131 °F) Ex de IIB T4 (-50 °C to +70 °C) (-58 °F to +158 °F)
Storage temperature	-50 °C to +70 °C (-58 °F to +158 °F)
Relative humidity	max. 90 %
Rated voltage	24 V DC
Operating voltage	18 V - 30 V DC
Rated current consumption	approx. 900 mA
Duty cycle	100 %
Tones	32
Sound pressure	up to 115.2 dB (A) 1 m
Sound range	approx. 30000 m ² (322917 square foot), Ø 200 m (7874 inch)
Weight	3700 g (8.2 lbs)
Dimensions	220 x 326 mm (dia. x W) 8.7 x 12.8 inch (dia. x W)

Part no.: 902254

Audible notification device for signaling fire hazards. The sounder is especially suitable for use in industrial environments with hazardous areas in zone 1. Equipped with an electronic module for operation directly on a primary control group of the fire alarm panel via a voltage increase.

Included in delivery

1 Sounder BExS120E MX

Not included in delivery

Mounting hardware
Cable glands

Connection / mounting

Recommended cable 2-wire
Conductor cross-section max. 4 mm² (AWG 11)

Note

The sounder can be operated via the voltage increase function as well as via the voltage reversal function at the fire detection and suppression control panels FMZ 5000, FMZ 5000 mod S or Clunid. The device has an integrated reverse polarity protection diode.

Approvals / marking

Ex classification:

II 2G Ex de IIC T4
II 2G Ex de IIB T4





Notification devices

Audible, Ex

Sounder YA90 MX Ex



Product features

- Explosion-proof device for hazardous zone 1, 2, 21 and 22
- High volume up to 115 dB (A) / 1 m (39 inch)
- 32 standardized tone sequences selectable
- 2-stage alarm, independently selectable 2nd stage
- Tone selection via 5-way DIL switch

Technical specifications

Enclosure material	Fiberglass-reinforced polyester, red
Horn material	ABS, red
IP rating	IP 66
Operating temperature	-40 °C to +60 °C (-40 °F to +140 °F)
Storage temperature	-40 °C to +70 °C (-40 °F to +158 °F)
Relative humidity	max. 95 %
Rated voltage	24 V DC
Operating voltage	18 V - 30 V DC
Rated current consumption	300 mA
Tones	32
Sound pressure	up to 115 dB (A) 1 m
Weight	4500 g (9.9 lbs)
Dimensions	210 x 210 x 316 mm (WxHxD) 8.3 x 8.3 x 12.4 inch (WxHxD)

Part no.: 910654

Audible alarm device for signaling danger of fire that is especially suitable for use in industrial environments with hazardous areas in zone 1, 2, 21 and 22. Equipped with an electronic module for operation directly on a primary control group of the fire alarm panel via a voltage increase. The robust fiberglass-reinforced polyester (FRP) housing is resistant to environmental effects and chemicals.

Included in delivery

- 1 Sounder YA90 MX Ex
- 1 Dust cover
- 1 Blanking plug M20

Not included in delivery

Mounting hardware

Connection / mounting

Recommended cable 2-wire
Conductor cross-section max. 2.5 mm² (AWG 13)

Note

The sounder can be operated via the voltage increase function as well as via the voltage reversal function at the fire detection and suppression control panels FMZ 5000, FMZ 5000 mod S or Clunid. The device has an integrated reverse polarity protection diode.

Approvals / marking

Ex classification: II 2G Ex d IIC T6 Ta -60°C to +60°C Gb
 II 2D Ex tb IIIC T85°C Ta -60°C to +60°C Db IP 66





Notification devices

Audible, Ex

Sounder YA60 MX Ex



Product features

- Explosion-proof device for hazardous zone 1, 2, 21 and 22
- Max. 110 dB (A) / 1 m omnidirectional sound output
- 32 standardized tone sequences selectable
- 2-stage alarm, independently selectable 2nd stage
- Tone selection via DIL switch

Technical specifications

Enclosure material	Diecast aluminium, red
Horn material	ABS, red
IP rating	IP 66
Operating temperature	-35 °C to +60 °C (T4 / T135°C) (-31 °F to +140 °F (T4 / T135°C)) -35 °C to +40 °C (T6 / T85°C) (-31 °F to +140 °F (T6 / T85°C))
Storage temperature	-35 °C to +60 °C (-31 °F to +140 °F)
Relative humidity	max. 95 %
Rated voltage	24 V DC
Operating voltage	18 V - 30 V DC
Rated current consumption	350 mA
Tones	32
Sound pressure	up to 110 dB (A) 1 m
Weight	5400 g (11.9 lbs)
Dimensions	288 x 145 mm (HxD) 11.3 x 5.7 inch (HxD)

Part no.: 910655

Audible alarm device for signaling danger of fire that is especially suitable for use in industrial environments with hazardous areas in zone 1,2, 21 and 22. Equipped with an electronic module for operation directly on a primary control group of the fire alarm panel via a voltage increase. The robust aluminium housing is resistant to sea water, environmental effects and chemicals.

Included in delivery

- 1 Sounder YA60 MX Ex
- 1 Dust cover
- 1 Blanking plug M20

Not included in delivery

Mounting hardware

Connection / mounting

Recommended cable 2-wire
Conductor cross-section max. 2.5 mm² (AWG 13)

Note

The sounder can be operated via the voltage increase function as well as via the voltage reversal function at the fire detection and suppression control panel FMZ 5000, FMZ 5000 mod S or Clunid. The device has an integrated reverse polarity protection diode.

Approvals / marking

Ex classification: Ex II 2G Ex d IIB T4 Ta -35°C to +60°C Gb
 Ex II 2G Ex d IIB T6 Ta -35°C to +40°C Gb
 Ex II 2D Ex tb IIIC T135°C Ta -35°C to +60°C Db IP 66
 Ex II 2D Ex tb IIIC T85°C Ta -35°C to +40°C Db IP 66





Notification devices

Visual

Beacon PY X-S-05-SSM 24 DC red



Technical specifications

Dome material	PC, red
Enclosure material	PC / ABS Blend, red
Approved category according EN 54-23	O
Flash technology	Xenon
Flash colour	red
IP rating	IP 66
Operating temperature	-40 °C to +55 °C (-40 °F to +131 °F)
Relative humidity	max. 90 %
Operating voltage	18 V - 30 V DC
Rated current consumption ¹⁾	300 mA (at 24 V DC / 1 Hz)
Current consumption max. (acc. to UL)	360 mA (at 24 V DC)
Power consumption ¹⁾	approx. 7.2 W
Power consumption max. (acc. to UL)	9.5 W
Luminous intensity	13 cd
Flash energy	5 Joule
Flash rate	1 Hz = 60 flashes / min.
Weight	200 g (0.44 lbs)
Dimensions	109.5 x 86 x 80.6 mm (WxHxD) 4.31 x 3.39 x 3.17 inch (WxHxD)

¹⁾ The manufacturer's technical documentation exclusively lists the data according to UL specifications. In some cases, these deviate significantly from the values to be expected in reality.

Part no.: 914142

Visual notification device in red colour for signaling fire hazards, approved according to EN 54-23 and VdS. The beacon is impressive due to its safe and simple mounting with external lugs or internal holes, simple electrical connection on the bottom of the casing. Impact-proof lens. Equipped with an electronic soft start module for operation directly on a primary control group of the fire alarm panel via a voltage increase.

Included in delivery

1 Beacon PY X-S-05-SSM 24 DC red

Not included in delivery

Mounting hardware
Cable glands

Connection / mounting

Recommended cable 2-wire
Conductor cross-section max. 2.5 mm² (AWG 13)

Note

The beacon has three pre-cut cable openings. The device can be operated via the voltage increase function as well as via the voltage reversal function at the fire detection and suppression control panels FMZ 5000, FMZ 5000 mod S or Clunid. The device has an integrated reverse polarity protection diode.

Approvals / marking



G 212186



0786-CPD-21219



Design parameters

See next page

Beacon PY X-S-05-MX 24 DC red

Part no.: 920565

Otherwise like part no. 914142

Approvals / marking



G 214121



0786-CPR-21435

Note

The device, without soft start module, can be operated at the fire detection and suppression control panels FMZ 5000, FMZ 5000 mod S or Clunid only via the voltage reversal softfunction.



Notification devices

Visual

Beacon PY X-S-05-SSM 24 DC red

Design parameters

(optimal mounting alignment)

Category O

O - 5.6 - 6.1 - 4.9 / V = 167,3 m³

Category O is designed as a cuboid.

Design legend:

O = open mounting position

5.6 = max. edge length in m

6.1 = max. edge length in m

4.9 = max. edge length in m

Mounting height = max. 2,8 m (wall mounting only)

Ceiling mounting

(Dimensions in m)

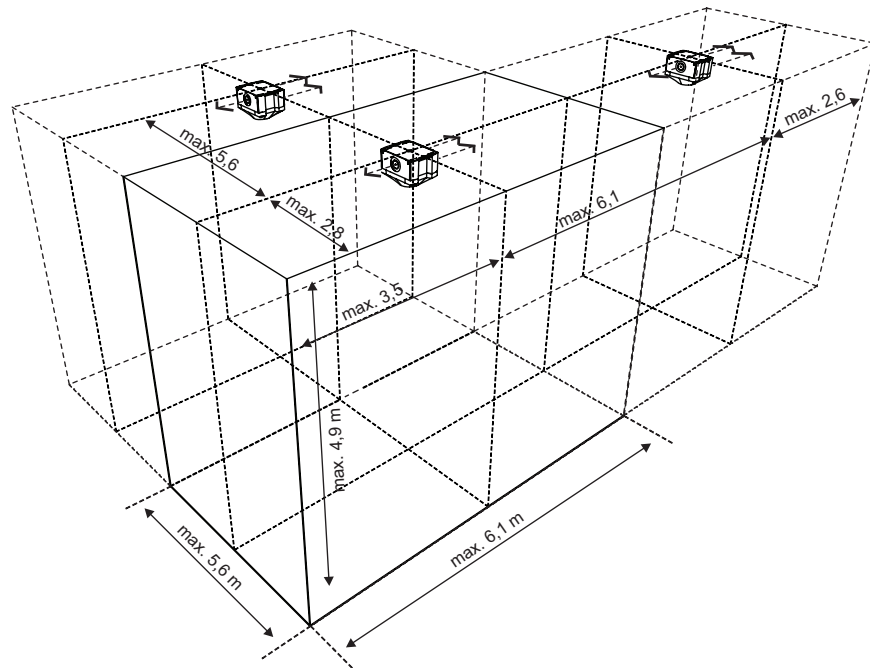

Wall mounting

(Dimensions in m)

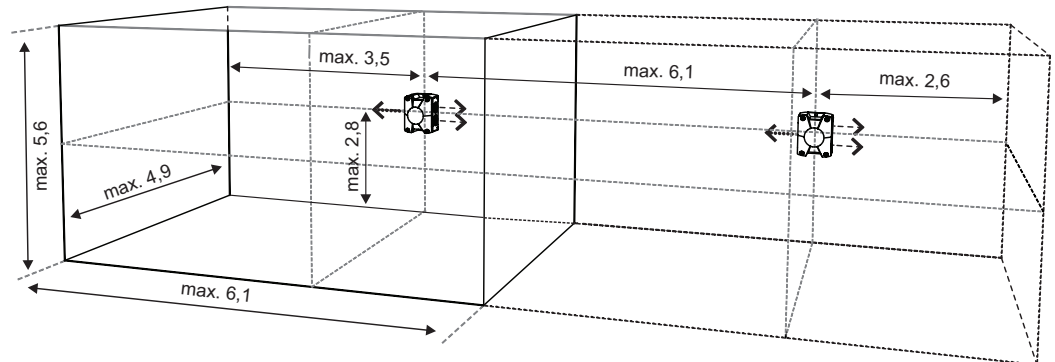



Notification devices

Visual

Beacon PY X-S-05-SSM 24 DC clear



Technical specifications

Dome material	PC, clear
Enclosure material	PC / ABS Blend, red
Approved category according EN 54-23	O
Flash technology	Xenon
Flash color	clear
IP rating	IP 66
Operating temperature	-40 °C to +55 °C (-40 °F to +131 °F)
Relative humidity	max. 90 %
Operating voltage	18 V - 30 V DC
Rated current consumption ¹⁾	300 mA (at 24 V DC / 1 Hz)
Current consumption max. (acc. to UL)	360 mA (at 24 V DC)
Power consumption ¹⁾	approx. 7.2 W
Power consumption max. (acc. to UL)	9.5 W
Luminous intensity	55 cd
Flash energy	5 Joule
Flash rate	1 Hz = 60 flashes / min.
Weight	200 g (0.44 lbs)
Dimensions	109.5 x 86 x 80.6 mm (WxHxD) 4.31 x 3.39 x 3.17 inch (WxHxD)

¹⁾ The manufacturer's technical documentation exclusively lists the data according to UL specifications. In some cases, these deviate significantly from the values to be expected in reality.

Part no.: 914143

Visual notification device in clear color for signaling fire hazards, approved according to EN 54-23 and VdS. The beacon is impressive due to its safe and simple mounting with external lugs or internal holes, simple electrical connection on the bottom of the casing. Impact-proof lens. Equipped with an electronic soft start module for operation directly on a primary control group of the fire alarm panel via a voltage increase.

Included in delivery

1 Beacon PY X-S-05-SSM 24 DC clear

Not included in delivery

Mounting hardware
Cable glands

Connection / mounting

Recommended cable 2-wire
Conductor cross-section max. 2.5 mm² (AWG 13)

Note

The beacon has three pre-cut cable openings. The device can be operated via the voltage increase function as well as via the voltage reversal function at the fire detection and suppression control panel FMZ 5000, FMZ 5000 mod S or Clunid. The device has an integrated reverse polarity protection diode.

Approvals / marking

VdS G 212186 CE 0786-CPD-21219



Design parameters

See next page

Beacon PY X-S-05-MX 24 DC clear

Part no.: 920566

Otherwise like part no. 914143

Approvals / marking

VdS G 214121 CE 0786-CPR-21435

Note

The device, without soft start module, can be operated only via the voltage reversal function at the fire detection and suppression control panel FMZ 5000, FMZ 5000 mod S or Clunid.



Notification devices

Visual

Beacon PY X-S-05-SSM 24 DC clear

Design parameters

(optimal mounting alignment)

Category O

O - 10.2 - 11.3 - 8.7 / V = 1002,7 m³

Category O is designed as a cuboid.

Ceiling mounting

(Dimensions in m)

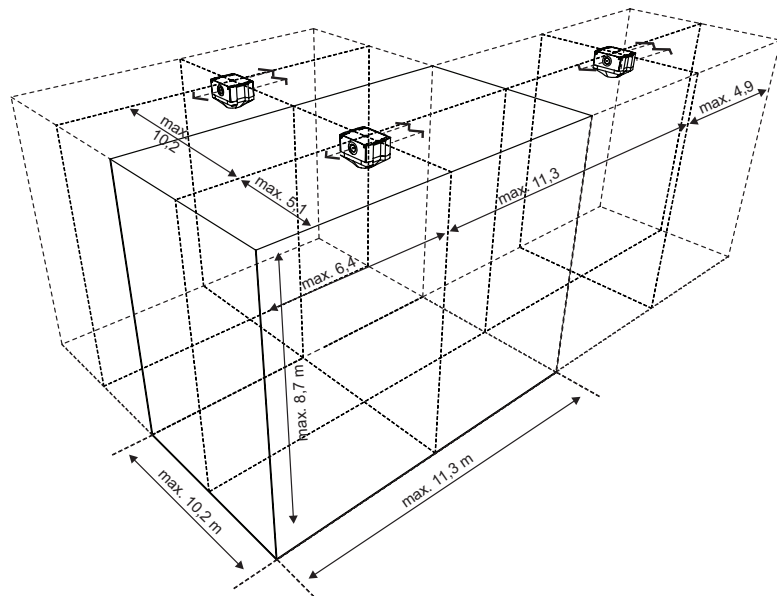

Wall mounting

(Dimensions in m)

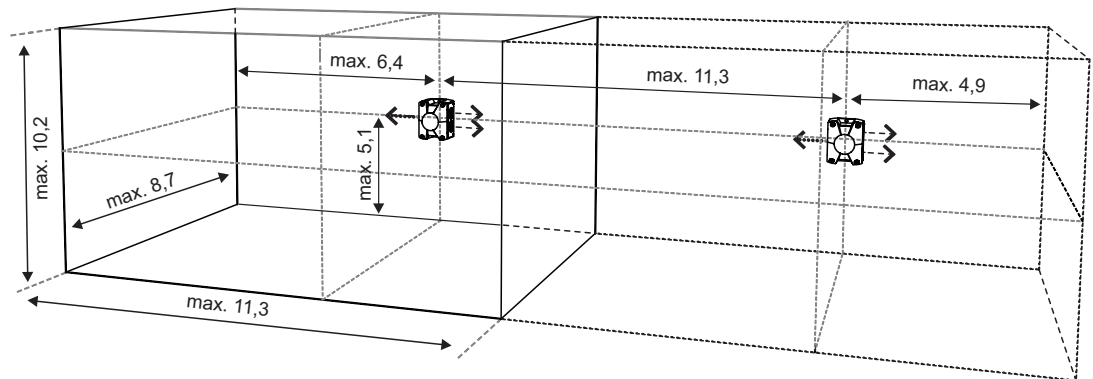



Notification devices

Visual

Beacon PY X-S-05-SSM 24 DC yellow

**Part no.: 916318**

Visual notification device in yellow color. The beacon is impressive due to its safe and simple mounting with external lugs or internal holes, simple electrical connection on the bottom of the casing. Impact-proof lens. Equipped with an electronic soft start module for monitoring of open and short circuits via the fire alarm panel.

Technical specifications

Dome material	PC, yellow
Enclosure material	PC / ABS Blend, grey
Flash technology	Xenon
Flash color	yellow
IP rating	IP 66
Operating temperature	-40 °C to +55 °C (-40 °F to +131 °F)
Relative humidity	max. 90 %
Operating voltage	18 V - 30 V DC
Rated current consumption ¹⁾	300 mA (at 24 V DC / 1 Hz)
Current consumption max. (acc. to UL)	360 mA (at 24 V DC)
Power consumption ¹⁾	approx. 7.2 W
Power consumption max. (acc. to UL)	9.5 W
Luminous intensity	51 cd
Flash energy	5 Joule
Flash rate	1 Hz = 60 flashes / min.
Weight	200 g (0.44 lbs)
Dimensions	109.5 x 86 x 80.6 mm (WxHxD) 4.31 x 3.39 x 3.17 inch (WxHxD)

¹⁾ The manufacturer's technical documentation exclusively lists the data according to UL specifications. In some cases, these deviate significantly from the values to be expected in reality.

Included in delivery

1 Beacon PY X-S-05-SSM 24 DC yellow

Not included in delivery

Mounting hardware
Cable glands

Connection / mounting

Recommended cable 2-wire
Conductor cross-section max. 2.5 mm² (AWG 13)

Note

The beacon has three pre-cut cable openings. The device can be operated via the voltage increase function as well as via the voltage reversal function at the fire detection and suppression control panel FMZ 5000, FMZ 5000 mod S or Clunid.

The device has an integrated reverse polarity protection diode.

Approvals / marking



G 217016



Notice!

No approval according to EN 54-23.



Notification devices

Visual



Beacon PY X-S-05-SSM 24 DC blue

Part no.: 916319

Technical specifications

Dome material	PC, blue
Flash color	blue
Luminous intensity	13 cd

Otherwise like part no. 916318

Beacon PY X-S-05-SSM 24 DC green

Part no.: 916320

Technical specifications

Dome material	PC, green
Flash color	green
Luminous intensity	14 cd

Otherwise like part no. 916318



Notification devices

Visual

Beacon PY X-M-10-SSM 24 DC red



Product features:

- Safe and fast assembly
- Large signaling range due to Xenon technology
- Can be mounted using external lugs or internal holes
- Four different flash frequencies
- (selectable via DIP switches)
- Beacons can operate synchronized with each other
- Electromagnetic constant current control to avoid load fluctuations

Technical specifications

Dome material	PC, red
Enclosure material	PC / ABS Blend, red
IP rating	IP 66
Operating temperature	-40 °C to +55 °C (-40 °F to +131 °F)
Relative humidity	max. 90 %
Operating voltage	18 V to 30 V DC
Rated current consumption	540 mA (at 24 V DC)
Power consumption	13 W
Flash rate	0.1, 0.5, 0.75, 1 Hz.
Weight	440 g (0.97 lbs)
Dimensions	166 x 124 x 114 mm (WxHxD) 6.54 x 4.88 x 4.49 inch (WxHxD)

Part no.: 927264

Visual notification device for signaling of fire hazards, approved according to EN54-23 in category O and VdS in red. The beacon is characterized by its large signaling range. Mounting in different orientations due to the approval according to category O. The housing is impact resistant. Equipped with an electronic soft start module for operating at a primary control unit of the fire alarm panel via voltage increase.

Included in delivery

1 Beacon PY X-M-10-SSM 24 DC red

Not included in delivery

Mounting hardware
Cable glands

Connection / mounting

Recommended cable 2-wire
Conductor cross-section max. 2.5 mm² (AWG 13)

Note

The Beacon PY X-X-10-SSM has different signaling ranges with regard to the lateral radiations. The beacon has four pre-cut cable openings (M20). The device can be operated via the voltage increase function as well as via the voltage reversal function. The device has an integrated reverse polarity protection diode.

Approvals / marking



G 216036



0786-CPR-21499





Notification devices

Visual

Beacon PY X-M-10-SSM 24 DC rot

Design parameters

(optimal mounting alignment)

Category O

O - 11.2 - 14.0 - 7.0 / V = 1098 m³

Category O is designed as a cuboid.

Example ceiling mounting (Dimensions in m)

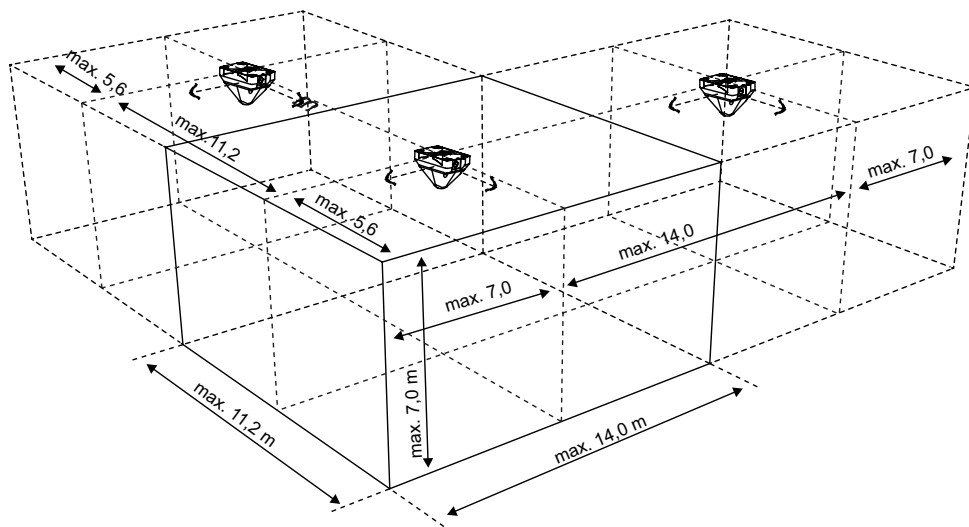

Example wall mounting (Dimensions in m)

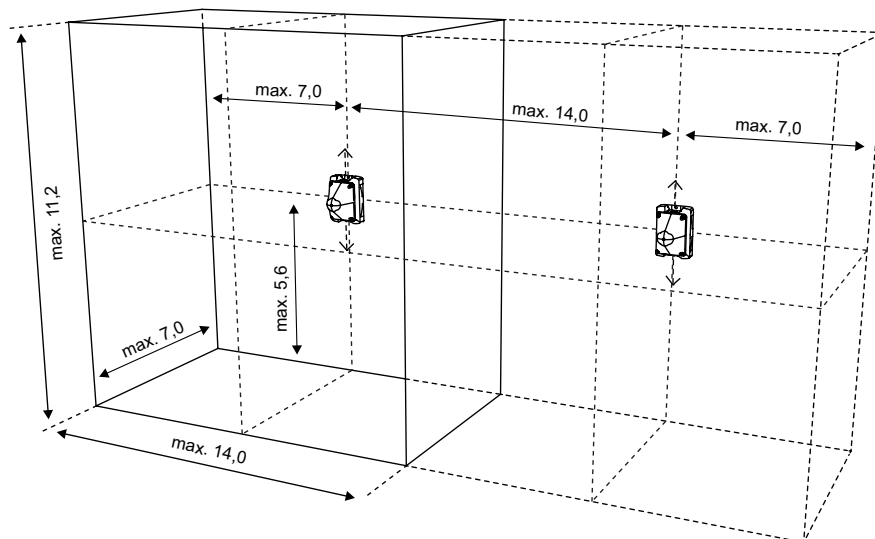



Notification devices

Visual

Beacon High Candela SRHK



Product features

- High candela range
- Field-selectable candela settings via slide switch (135, 150, 177 or 185 cd)
- Compatible with Synchronization module MDL3R
- For outdoor use

Technical specifications

Enclosure material	PC, red
Flash technology	Xenon
Flash colour	white
IP rating	IP 56
IP rating (American NEMA Standard Publ. 250)	NEMA 4X
Operating temperature	-40°C to +66°C (-40 °F to +150.8 °F)
Rated voltage	24 V DC
Operating voltage	16 - 33 V DC
Rated current consumption	228 - 286 mA depending on candela setting
Flash rate	1 Hz = 60 flashes / min.
Weight	500 g (1.1 lbs)
Dimensions	119 x 142 x 64 mm (WxHxD) 4.7 x 5.6 x 2.5 inch (WxHxD)

Part no.: 918429

Visual notification device for signaling fire hazards. This beacon is listed for ceiling or wall mounting. Compatible with Synchronization module MDL3R.

Included in delivery

1 Beacon High Candela SRHK
1 Weatherproof back box

Not included in delivery

Synchronization module MDL3R
Mounting hardware
End of line-resistor and diode

931853

Connecting / mounting

Recommended cable 2-wire
Conductor cross-section max. 3.3 mm² (AWG 12)

Note

Applicable for operation at fire detection und suppression control panels FMZ 5000 mod S CA or Clunid. Distribution only to non-EU countries.

Approvals / marking

**MEA**



Notification devices

Visual

Strobe SRL



Product features

- Field-selectable candela settings via slide switch (15, 30, 75, 95, 110, 135 or 185 cd)
- For indoor use
- Impact resistant housing
- Compatible with Synchronization module MDL3R
- Simple installation due to separate mounting plate with integrated short-circuit spring

Technical specifications

Flash colour	white
Rated voltage	12 V DC 24 V DC
Operating voltage	8 - 17.5 (12 V) DC 16 - 33 V (24 V) DC
Operating voltage with MDL3 Sync module	8.5 - 17.5 V (12 V) DC 16.5 - 33 V (24 V) DC
Rated current consumption	43 - 222 mA depending on candela setting
Flash rate	1 Hz = 60 flashes / min.
Operating temperature	0 °C to +49°C (+32 °F to +120 °F)
Weight	360 g (0.8 lbs)
Dimensions	119 x 143 x 49 mm (WxHxD) 4.7 x 5.6 x 1.9 inch (WxHxD)

Part no.: 927475

Visual notification device for signaling fire hazards. This beacon is listed for wall mounting in indoor areas. Compatible with Synchronization module MDL3R.

Included in delivery

1 Strobe SRL
1 Mounting plate

Not included in delivery

Synchronization module MDL3R
Mounting hardware
1 End of line-resistor and diode

931853

Connecting / mounting

Recommended cable 2-wire
Conductor cross-section max. 3.3 mm² (AWG 12)

Note

Distribution only to non-EU countries.

Approvals / marking





Notification devices

Visual

Beacon L101X red



Part no.: 917444

Optical notification device for signaling fire hazards, approved according to EN 54-23 in categories C and O and VdS. The beacon can be mounted using external lugs or internal holes.

Technical specifications

Dome material	PC, red
Enclosure material	ABS, red
Approved categories according EN 54-23	C, O
Flash technology	Xenon
Flash colour	red
IP rating	IP 66
Operating temperature	-40 °C to +55 °C (-40 °F to +131 °F)
Storage temperature	-40 °C to +70 °C (-40 °F to +158 °F)
Rated voltage	24 V DC
Operating voltage	20 V to 28 V DC
Rated current consumption	approx. 275 mA
Power consumption	6 W
Flash energy	5 Joules
Flash rate	1 Hz = 60 flashes / min.
Weight	200 g (0.4 lbs)
Dimensions	114.6 x 86.4 x 83.3 mm (WxHxD) 4.5 x 3.4 x 3.3 inch (WxHxD)

Included in delivery

1 Beacon L101X red

Not included in delivery

Mounting hardware
Cable glands

Connection / mounting

Recommended cable 2-wire
Conductor cross-section max. 1.5 mm² (AWG 15)

Note

The beacon has two pre-cut M20 cable openings. The device can only be operated via the voltage reversal function at the fire detection and suppression control panel FMZ 5000, FMZ 5000 mod S or Clunid. The device has an integrated reverse polarity protection diode.

Approvals / marking



G 211077



0786-CPD-21247



Note approvals

This beacon cannot be included in the VdS system approval, due to its technical parameters (minimum operation voltage).

Design parameters

See next page



Notification devices

Visual

Beacon L101X red

Design parameters

Category O

O - $1.9 - 3.6 / V = 13.0 \text{ m}^3$

Category O is designed as a cuboid.

Example ceiling mounting (Dimensions in m)

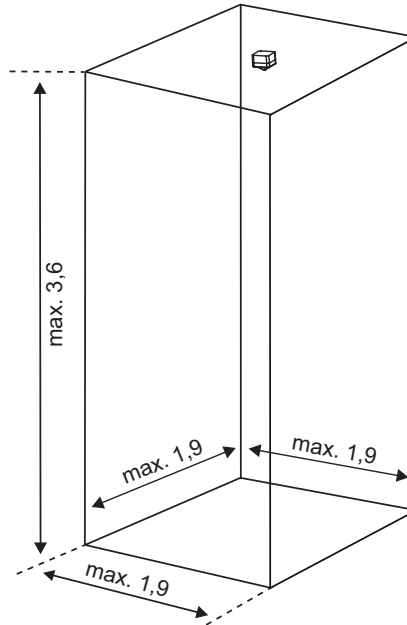

Example wall mounting (Dimensions in m)

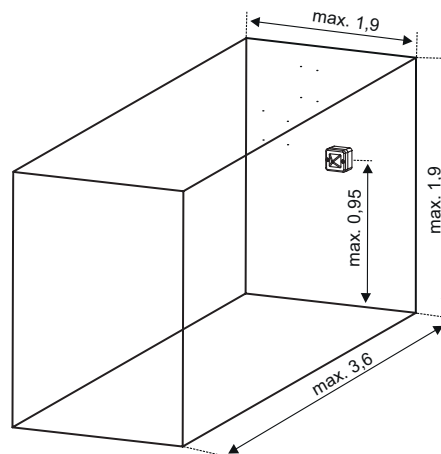

Category C

C - $3 - 2.6 / V = 15.9 \text{ m}^3$

Category C is designed as a cylinder.

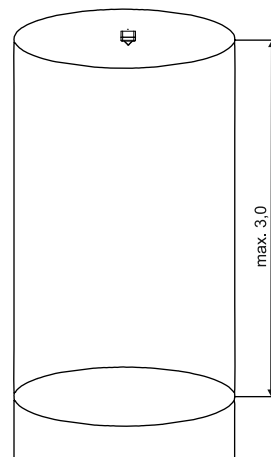



Notification devices

Visual

Beacon L101X clear



Part no.: 917443

Optical notification device for signaling fire hazards, approved according to EN 54-23 in categories C, W, O and VdS. The beacon can be mounted using external lugs or internal holes.

Technical specifications

Dome material	PC, clear
Enclosure material	ABS, red
Approved categories according to EN 54-23	C, W, O
Flash technology	Xenon
Flash colour	clear
IP rating	IP 66
Operating temperature	-40 °C to +55 °C (-40 °F to +131 °F)
Storage temperature	-40 °C to +70 °C (-40 °F to +158 °F)
Rated voltage	24 V DC
Operating voltage	20 V to 28 V DC
Rated current consumption	approx. 250 mA
Power consumption	6 W
Flash energy	5 Joules
Flash rate	1 Hz = 60 flashes / min.
Weight	200 g (0.4 lbs)
Dimensions	114.6 x 86.4 x 83.3 mm (WxHxD) 4.5 x 3.4 x 3.3 inch (WxHxD)

Included in delivery

1 Beacon L101X clear

Not included in delivery

Mounting hardware
Cable glands

Connection / mounting

Recommended cable 2-wire
Conductor cross-section max. 1.5 mm² (AWG 15)

Note

The beacon has two pre-cut M20 cable openings. The device can only be operated via the voltage reversal function at the fire detection and suppression control panel FMZ 5000, FMZ 5000 mod S or Clunid. The device has an integrated reverse polarity protection diode.

Approvals / marking



G 211077



0786-CPD-21247



Note approvals

This beacon cannot be included in the VdS system approval FMZ 5000 or Clunid, due to its technical parameters (minimum operation voltage).

Design parameters

See next page



Notification devices

Visual

Beacon L101X clear

Design parameters

Category O

O - 4,8 - 10 / V = 230,4 m³

Category O is designed as a cuboid.

Example ceiling mounting

(Dimensions in m)

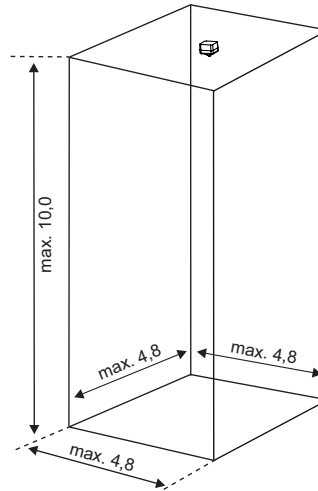

Example wall mounting

(Dimensions in m)

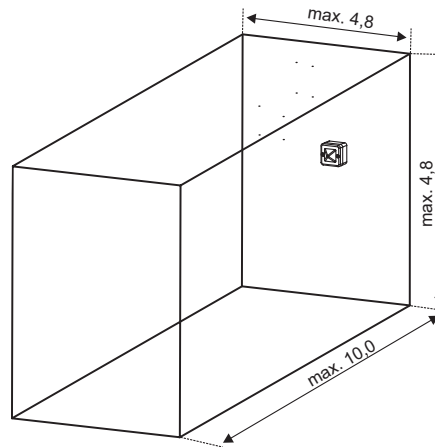

Category C

C - 9 - 6,8 / V = 326,9 m³

Category C is designed as a cylinder.

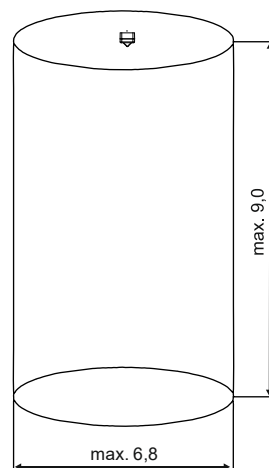



Notification devices

Visual

Beacon Solista LX Wall red



Part no.: 917446

Optical notification device for signaling fire hazards, approved according to EN 54-23 in category W. The flash rate and the high power or lower power application can be set using the DIP switches.

Technical specifications

Enclosure material	ABS, red
Approved categories according EN 54-23	W
Flash technology	LED
Flash colour	red
IP rating	IP 65
Operating temperature	-25 °C to +70 °C (-13 °F to +158 °F)
Storage temperature	-25 °C to +70 °C (-13 °F to +158 °F)
Rated voltage	24 V DC
Operating voltage	9 V to 60 V DC
Rated current consumption at 24 V DC	High Power 1 Hz: 25 mA High Power 0,5 Hz: 16 mA Low Power 1 Hz: 16 mA Low Power 0,5 Hz: 10 mA
Surge current	< 120 % for 10 ms
Power consumption	max. 1,5 W
Flash rate adjustable	0.5 Hz = 30 flashes / min. 1 Hz = 60 flashes / min.
Weight	100 g (0.2 lbs)
Dimensions	93 x 66 mm (dia.xH) 3.6 x 2.6 inch (dia.xH)

Included in delivery

1 Beacon Solista LX Wall red

Not included in delivery

Mounting hardware
Cable glands

Connection / mounting

Recommended cable 2-wire
Conductor cross-section max. 2.5 mm² (AWG 13)

Note

The beacon has two pre-cut M20 cable openings. The device can only be operated via the voltage reversal function at the fire detection and suppression control panels FMZ 5000, FMZ 5000 mod S or Clunid. The device has an integrated reverse polarity protection diode.

Approvals / marking



G 214067



0333-CPD-075441

Design parameters

Category W

W - 2.4 - 7.5 / V = 135 m³ (high power)

W - 2.4 - 2.5 / V = 15 m³ (low power)

Category W is designed as a cube.

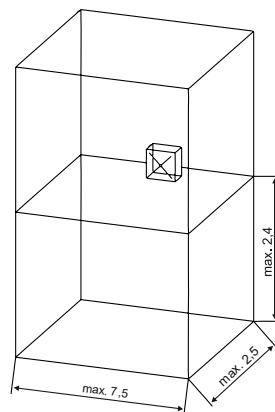



Notification devices

Visual

Beacon Solista LX Wall clear

Part no.: 917445

Otherwise like part no. 917446



Technical specifications

Flash colour	clear
--------------	-------



Notification devices

Visual

Beacon Solista LX Wall red, shallow



Technical specifications

Enclosure material	ABS, red
Approved categories according EN 54-23	W
Flash technology	LED
Flash colour	red
IP rating	IP33c
Operating temperature	-25 °C to +70 °C (-13 °F to +158 °F)
Storage temperature	-25 °C to +70 °C (-13 °F to +158 °F)
Rated voltage	24 V DC
Operating voltage	9 V - 60 V DC
Rated current consumption at 24 V DC	High Power 1 Hz: 25 mA High Power 0.5 Hz: 16 mA Low Power 1 Hz: 16 mA Low Power 0.5 Hz: 10 mA
Surge current	< 120 % for 10 ms
Power consumption	max. 1.5 W
Flash rate adjustable	0.5 Hz = 30 flashes / min. 1 Hz = 60 flashes / min.
Weight	90 g (0.2 lbs)
Dimensions	93 x 38 mm (dia.xH) 3.6 x 1.5 inch (dia.xH)

Design parameters

Category W

W - 2.4 - 7.5 / V = 135 m³ (high power)W - 2.4 - 2.5 / V = 15 m³ (low power)

Category W is designed as a cube.

Part no.: 4003600

Optical notification device for signaling fire hazards, approved according to EN 54-23 in category W.

The flash rate and the high power or lower power application can be set using the DIP switches.

Included in delivery

1 Beacon Solista LX Wall red, shallow

Not included in delivery

Mounting hardware

Connection / mounting

Recommended cable

2-wire

Conductor cross-section

max. 2.5 mm² (AWG 13)

Note

The device can only be operated via the voltage reversal function at the fire detection and suppression control panels FMZ 5000, FMZ 5000 mod S or Clunid. The device has an integrated reverse polarity protection diode.

Approvals / marking



G 214067



0333-CPD-075441

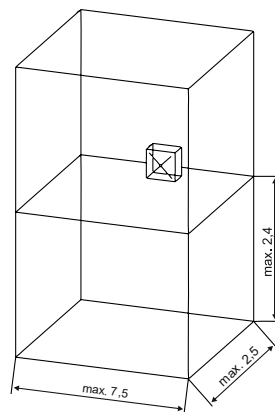



Notification devices

Visual

Beacon LX Ceiling red



Part no.: 917448

Optical notification device for signaling fire hazards, approved according to EN 54-23 in category C. The flash rate and the high power or lower power application can be set using the DIP switches.

Technical specifications

Enclosure material	ABS, white
Approved categories according EN 54-23	C
Flash technology	LED
Flash colour	red
IP rating	IP 33 IP 65 with extension base (917449)
Operating temperature	-25 °C to +70 °C (-13 °F to +158 °F)
Storage temperature	-25 °C to +70 °C (-13 °F to +158 °F)
Rated voltage	24 V DC
Operating voltage	9 V to 60 V DC
Rated current consumption at 24 V DC	High Power 1 Hz: 25 mA High Power 0.5 Hz: 16 mA Low Power 1 Hz: 16 mA Low Power 0.5 Hz: 10 mA
Surge current	< 120 % for 10 ms
Power consumption	max. 1.5 W
Flash rate adjustable	0.5 Hz = 30 flashes / min. 1 Hz = 60 flashes / min.
Weight	100 g (0.2 lbs)
Dimensions	93 x 38 mm (dia.xH) 3.6 x 2.6 inch (dia.xH)

Design parameters

Category C

C - 3 - 7.5 / V = 132 m³ (high power)

C - 3 - 3 / V = 21.2 m³ (low power)

Category C is designed as a cylinder.)

Included in delivery

1 Beacon Solista LX Ceiling red

Not included in delivery

Mounting hardware
Cable glands

Connection / mounting

Recommended cable 2-wire
Conductor cross-section max. 2.5 mm² (AWG 13)

Note

The device can only be operated via the voltage reversal function at the fire detection and suppression control panel FMZ 5000, FMZ 5000 mod S or Clunid. The device has an integrated reverse polarity protection diode. The Extension base Solista Ceiling IP 65, part no. 917449, must be additionally ordered to increase the IP rating to IP 65.

Approvals / marking



G 214069



0333-CPD-075443

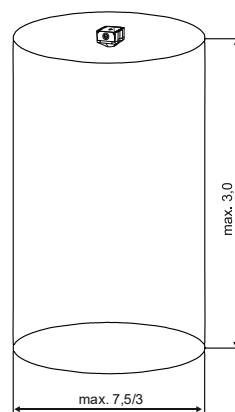



Notification devices

Visual

Beacon Solista LX Ceiling clear

Part no.: 917447

Otherwise like part no. 917448



Technical specifications

Flash colour	clear
--------------	-------

Design parameters

Category C

C - 3 - 7.5 / V = 132 m³ (high power)

C - 3 - 5 / V = 58.9 m³ (low power)

Category C is designed as a cylinder.

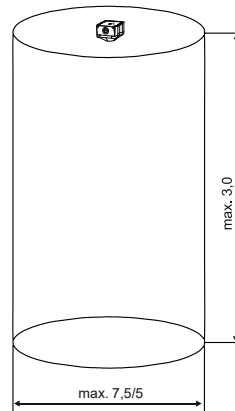



Notification devices

Visual

Beacon Solex MX



Part no.: 908632

Optical notification device for signaling fire hazards.

Technical specifications

Dome material	PC, red
Enclosure material	ABS, red
IP rating	IP 65
Ambient temperature	-25 °C to +70 °C (-13 °F to +158 °F)
Rated voltage	24 V DC
Operating voltage	10 V - 60 V DC
Rated current consumption	100 mA
Power consumption	2.4 W
Luminous intensity	10 cd
Flash rate	1 Hz = 60 flashes / min.
Weight	180 g (0.4 lbs)
Dimensions	93 x 121 mm (WxH) 3.7 x 4.8 inch (WxH)

Included in delivery

1 Beacon Solex MX

Not included in delivery

Mounting hardware
Cable glands

Note

The beacon can only be operated via the voltage reversal function at the fire detection and suppression control panel. The device has an integrated reverse polarity protection diode.

Approvals / marking



Notice!

This beacon must not be used for alerting and evacuation of people in fire alarm or gas extinguishing systems.

The device is not EN 54-23 or VdS approved.



Notification devices

Visual

Rotating beacon R401-61 red



Part no.: 917450

Optical notification device for signaling fire hazards. 360° rotating beacon with parabola reflector. The connection cable can be inserted via an M20 cable opening or through the base of the rotating beacon.

Technical specifications

Dome material	PC, red
Base material	ABS, black
IP rating	IP 65
Operating temperature	-10 °C to +55 °C (14 °F to +131 °F)
Storage temperature	-10 °C to +55 °C (14 °F to +131 °F)
Rated voltage	24 V DC
Operating voltage	20 V - 28 V DC
Rated current consumption	0.95 A
Power consumption	21 W
Weight	980 g (2.2 lbs)
Dimensions	150 x 205 mm (DxH) 5.9 x 8.1 inch (DxH)

Included in delivery

1 Rotating beacon R401-61 red
1 Foam rubber disk

Not included in delivery

Mounting hardware
Cable glands

Connection / mounting

Recommended cable 2-wire
Conductor cross-section max. 2.5 mm² (AWG 13)

Note

The rotating beacon has a pre-cut M20 cable opening. The device can only be triggered via relay contacts.

Approvals / marking



Rotating beacon R401-61 amber



Part no.: 917451

Otherwise like part no. 917450

Technical specifications

Dome material	PC, amber
---------------	-----------



Notification devices

Visual, addressable

Loop Beacon LBX 877r



Technical specifications

Enclosure material	PC
IP rating	IP 23D
Technology / protocol	Loop AP / XP95
Enclosure colour	white
Spherical cup colour	red
Integrated isolator	no
Operating temperature	-20 °C to +60 °C (-4 °F to +140 °F)
Operating voltage	17 V - 28 V DC
Operating current siren	3 mA
Rated current consumption	150 µA
Relative humidity	0 - 95 % no condensation
Weight	140 g (0.30 lbs)
Dimensions	115 x 38 mm (dia.xH) 4.52 x 1.49 inch (dia.xH)

Part no.: 905820

Loop Beacon for optical signaling in red.
The beacon can be fitted to any Loop AP detector base.
Addressing is done via an integrated address card.

Included in delivery

1 Loop Beacon LBX 877r

Not included in delivery

Mounting hardware
Detector base for Loop AP

Connection / mounting

Cable recommendation standard

J-Y(St)Y -2x2x0.8 mm, red

Recommended cable

Conductor cross-section

Electrostatic shielding

747180

2-wire

max. 2.5 mm² (AWG 13)

not required

Approvals / marking



Notice!

This beacon must not be used for alerting and evacuation of people in fire alarm or gas extinguishing systems.

The device is not EN 54-23 or VdS approved.



Notification devices

Visual, addressable

Loop Beacon LBX 009r WP



Part no.: 912569

Loop beacon for the Loop AP for optical signaling with integrated dual isolator in red. Addressing is done via integrated DIP switches.

Technical specifications

Enclosure material	PC
IP rating	IP 65
Technology / protocol	Loop AP / XP95
Enclosure colour	red
Spherical cup colour	red
Integrated isolator	yes
Operating temperature	-10 °C to +55 °C (-14 °F to +131 °F)
Operating voltage	17 V - 28 V DC
Operating current siren	3.1 mA
Rated current consumption	330 µA
Weight	205 g (0.45 lbs)
Dimensions	104 x 97.5 mm (dia.xH) 4.09 x 3.83 inch (dia.xH)

Included in delivery

1 Loop Beacon LBX 009r WP

Not included in delivery

Mounting hardware

Connection / mounting

Cable recommendation standard

J-Y(St)Y -2x2x0.8 mm, red

Recommended cable

Conductor cross-section

Electrostatic shielding

747180

2-wire

max. 2.5 mm² (AWG 13)

not required

Approvals / marking



Notice!

This beacon must not be used for alerting and evacuation of people in fire alarm or gas extinguishing systems.

The device is not EN 54-23 or VdS approved.



Notification devices

Visual, Ex

Beacon Quadro-LED-HI 3G/3D Ex

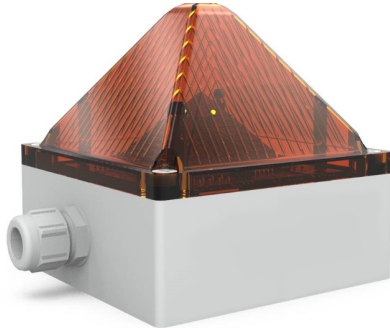

Product features

- Explosion-protected equipment
- Operating mode selectable from three alarm options: steady light, flashing light and strobe light
- High-performance LEDs with high signal effect
- Indoor and outdoor use under industrial conditions

Technical specifications

Dome material	PC, red
Enclosure material	PC, light grey RAL 7035
Light source	4 high-performance LEDs
Ambient temperature	-20 °C to +55 °C (T6) (-4 °F to +131 °F (T6))
Storage temperature	-40 °C to +70 °C (-40 °F to 158 °F)
Relative humidity	max. 90 %
Rated voltage	24 V DC
Steady light	n. a.
Flashlight	0.1 Hz = 6 flashes / min 0.5 Hz = 30 flashes / min 0.75 Hz = 45 flashes / min 1 Hz = 60 flashes / min 2 Hz = 120 flashes / min
Blinking light	1 Hz = 60 flashes / min 2 Hz = 120 flashes / min
Operating voltage	11 V - 60 V DC
Rated current consumption	195 mA @ 24 V DC
Application area	3G (zone 2), 3D (zone 22)
Luminous intensity (DIN 5037) clear cover	75 cd, adjustable 15 % - 100 %
IP rating (EN 60529)	IP 66/67, any mounting
Visibility max.	201 m (39.37 inch)
Service life of beacon	> 50.000 hrs
Duty cycle	100 %
Weight	500 g (1.1 lbs)
Dimensions	130 x 130 x 130 mm (WxHxD) 5.1 x 5.1 x 5.1 inch (WxHxD)

Part no.: 934803

Visual notification device for signaling fire hazards in potentially explosive atmospheres in zone 2 (EN 60079-10-1) and 22 (EN 60079-10-2). Use for gases of temperature classes T1-T6.

Included in delivery

1 Beacon Quadro-LED-HI 3G/3D Ex

Not included in delivery

Mounting hardware

Connection / mounting

Recommended cable 2-wire
Conductor cross-section 0.13 mm² to 2.5 mm²
(AWG 26 to AWG 14)

Note

The beacon can be operated only via voltage reversal function with fire detection and suppression control panels of the series FMZ 5000, FMZ 5000 mod S and Clunid. The device has an integrated reverse polarity protection. The function is guaranteed if the connections are reversed.

Approvals / marking

Ex classification:

II 3G Ex nRc IIC T6 X -20°C ≤ Ta ≤ +55°C
 II 3D Ex tc IIIB T80°C IP66/67 -20°C ≤ Ta ≤ +55°C





Notification devices

Visual, Ex

Beacon CWB-ATEX-MX Ex



Product features

- Explosion-protected equipment

Technical specifications

Dome material	PC, red
Enclosure material	Aluminium alloy, yellow/black
Flash energy	5 joules
Ambient temperatures	-40 °C to +40 °C (T6 / T85°C) (-40 °F to +104 °F (T6 / T85°C)) -40 °C to +50 °C (T5 / T100°C) (-40 °F to +122 °F (T5 / T100°C))
Storage temperature	-40 °C to +80 °C (-40 °F to +140 °F)
Relative humidity	max. 90 %
Rated voltage	24 V DC
Operating voltage	18 V - 30 V DC
Rated current consumption	400 mA
Power consumption	9.6 W
Luminous intensity	9 cd
IP rating	IP 66
Flash rate	1 Hz = 60 flashes / min.
Service life of beacon	approx. 5800 hrs
Duty cycle	100 %
Weight	1240 g (7.73 lbs)
Dimensions	70 x 260 mm (dia. x H) 2.8 x 10.2 inch (dia. x H)

Part no.: 903761

Visual notification device for signaling fire hazards in potentially explosive atmospheres in zone 1 as well as in zone 21. Application in chemical and petrochemical industry and offshore facilities. Fitted with an electronic module for monitoring directly on a primary control group of the fire alarm panel via a voltage increase.

Included in delivery

1 Beacon CWB-ATEX-MX Ex complete with mounting bracket

Not included in delivery

Mounting hardware

Connection / mounting

Recommended cable

2-wire

Conductor cross-section:

- power supply

max. 2.5 mm² (AWG 13)

- protective earth terminal

outside max. 6 mm² (AWG 9)

inside max. 2.5 mm² (AWG 13)

Note

The beacon can be operated via the voltage increase function as well as via the voltage reversal function at the fire detection and suppression control panel FMZ 5000, FMZ 5000 mod S or clunid.

The device has an integrated reverse polarity protection diode.

Approvals / marking

Ex classification:

Ex II 2G Ex de IIC T6/T5 Gb

Ex II 2D Ex tb IIIC T85°C/T100°C Db IP66





Notification devices

Visual, Ex



Beacon CWB-ATEX-MX Ex

Part no.: 905344

Otherwise like part no. 903761

Technical specifications

Dome material	PC, yellow
---------------	------------

Beacon CWB-ATEX-MX Ex

Part no.: 905343

Otherwise like part no. 903761

Technical specifications

Dome material	PC, blue
---------------	----------



Notification devices

Visual, Ex

Beacon FL60 MX Ex



Product features

- Explosion-proof device for hazardous zone 1 as well as 21
- Fitted as standard with protective cage

Technical specifications

Horn material	PC, red
Enclosure material	Diecast aluminium, red
Operating temperature	-35 °C to +60 °C (T4 / T135°C) (-31 °F to +140 °F (T4 / T135°F)) -35 °C to +40 °C (T6 / T85°C) (-31 °F to +104 °F (T6 / T85°F))
Storage temperature	-35 °C to +60 °C (-31 °F to +140 °F)
Relative humidity	max. 95 %
Rated voltage	24 V DC
Flash rate	1 Hz = 60 flashes / min.
Flash energy	5 J
Operating voltage	18 V - 30 V DC
Rated current consumption	approx. 220 mA
Power consumption	5.3 W
Luminous intensity	6.1 cd with continuous light
IP rating (EN 60529)	IP 66
Weight	5080 g (11.2 lbs)
Dimensions	276 x 145 mm (HxD) 10.9 x 5.7 inch (HxD)

Part no.: 910656

Optical alarm device for signaling danger of fire that is especially suitable for use in industrial environments with hazardous areas in zone 1 as well as 21. Equipped with an electronic module for operation directly on a primary control group of the fire alarm panel via a voltage increase. The robust aluminium housing is resistant to sea water, environmental effects and chemicals.

Included in delivery

- 1 Beacon FL60 MX Ex
- 1 Blanking plug

Not included in delivery

Mounting hardware

Connection / mounting

Recommended cable 2-wire
Conductor cross-section: 2.5 mm² (AWG 13)

Note

The beacon can be operated via the voltage increase function as well as via the voltage reversal function at the fire detection and suppression control panel FMZ 5000, FMZ 5000 mod S or Clunid. The device has an integrated reverse polarity protection diode.

Approvals / marking

Ex classification: Ex II 2G Ex d IIB T4 Ta -35°C to +60°C Gb
 Ex II 2G Ex d IIB T6 Ta -35°C to +40°C Gb
 Ex II 2D Ex tb IIIC T135°C Ta -35°C to +60°C Db IP 66
 Ex II 2D Ex tb IIIC T85°C Ta -35°C to +40°C Db IP 66





Notification devices

Visual, Ex

Beacon BExBG05E MX Ex



Product features

- Explosion-proof equipment for Ex zone 1 as well as 21
- Fitted as standard with protective cage

Technical specifications

Spherical calotte material	Borosilicate glass, red
Enclosure material	Aluminium, red
Operating temperature 2G	-50 °C to +70 °C (T4) -58 °F to +158 °F (T4) -50 °C to +55 °C (T5) -58 °F to +131 °F (T5) -50 °C to +40 °C (T6) -58 °F to +104 °F (T6)
Rated voltage	24 V DC
Flash rate	1 Hz = 60 flashes / min.
Flash energy	5 J
Operating voltage	20 V - 28 V DC
Rated current consumption	approx. 300 mA
Power consumption	7.2 W
IP rating (EN 60529)	IP 66
Weight	2450 g (5.4 lbs)
Dimensions	295 x 154 mm (HxD) 11.61 x 6.06 inch (HxD) (without mounting bracket)

Part no.: 913425

Optical alarm device for signaling danger of fire that is especially suitable for use in industrial environments with hazardous areas in zone 1 as well as 21. Equipped with electronic module for operation directly on a primary control group of the fire alarm panel via a voltage increase. The robust aluminium housing is resistant to sea water, environmental effects and chemicals.

Included in delivery

1 Beacon BExBG05E MX Ex with mounting bracket

Not included in delivery

Mounting hardware

Connection / mounting

Recommended cable 2-wire
Conductor cross-section: 0.5 mm² to 4 mm²
(AWG 20 to AWG 11)

Note

The beacon can be operated via the voltage increase function as well as via the voltage reversal function at the fire detection and suppression control panels FMZ 5000, FMZ 5000 mod S or Clunid. The device has an integrated reverse polarity protection diode.

Approvals / marking

Ex classification: II 2G Ex de IIC T4 Ta.-50°C to +70°C
 II 2G Ex de IIC T5 Ta.-50°C to +55°C
 II 2G Ex de IIC T6 Ta.-50°C to +40°C
 II 2D tD A21 IP 66 T115°C





Notification devices

Audible / visual

Sounder / Beacon PA X-1-05-SSM 24 DC red

Part no.: 914144

Audible/visual notification device in red color for signaling fire hazards, approved according to EN 54-3, EN 54-23 and VdS. The sounder/beacon is impressive due to its safe and simple mounting with external lugs or internal holes, simple electrical connection on the bottom of the casing. The sounder/beacon is impact-proof. Equipped with an electronic soft start module for operation directly on a primary control group of the fire alarm panel via a voltage increase.

Technical specifications

Dome material	PC, red
Enclosure material	PC / ABS Blend, red
Approved categories according EN 54-23	O
Flash technology	Xenon
Flash color	red
IP rating	IP 66
Operating temperature	-40 °C to +55 °C (-40 °F to +131 °F)
Relative humidity	approx. 90 %
Operating voltage	18 V - 30 V DC
Rated current consumption: ¹⁾	
Beacon	300 mA (at 24 V DC / 1Hz)
Sounder	38 mA (at 24 V DC / DIN-tone)
Current consumption max. (acc. to UL):	
Beacon	360 mA (at 24 V DC)
Sounder	70 mA (at 24 V DC)
Power consumption ¹⁾	approx. 8.1 W
Power consumption max. (acc. to UL)	11.5 W
Luminous intensity	13 cd
Flash energy	5 Joule
Flash rate	1 Hz = 60 flashes / min.
Tones	80
Tone stages	3 additional ext. selectable
Sound level	max. 105 dB (A) / 1 m
Weight	560 g (1.23 lbs)
Dimensions	109.5 x 172.4 x 80.6 mm (WxHxD) 4.31 x 6.79 x 3.17 inch (WxHxD)

¹⁾ The manufacturer's technical documentation exclusively lists the data according to UL specifications. In some cases, these deviate significantly from the values to be expected in reality.

Included in delivery

1 Sounder / Beacon PA X-1-05-SSM 24 DC red

Not included in delivery

Mounting hardware
Cable glands

Connection / mounting

Recommended cable 2-wire
Conductor cross-section max. 2.5 mm² (AWG 13)

Note

The combination unit has three pre-cut cable openings. The device can be operated via the voltage increase function as well as via the voltage reversal function at the fire detection and suppression control panel FMZ 5000, FMZ 5000 mod S or Clunid. The device has an integrated reverse polarity protection diode.

Approvals / marking



G 212188



0786-CPD-21220



Beacon design parameters

See next page

Sounder / Beacon PA X-1-05-MX 24 DC red

Part no.: 920568

Otherwise like part no. 914144

Approvals / marking



G 214120



0786-CPR-21434

Note

The device, without soft start module, can be operated only via the voltage reversal function at the fire detection and suppression control panel FMZ 5000, FMZ 5000 mod S or Clunid.



Notification devices

Audible / visual

Sounder / Beacon PA X-1-05-SSM 24 DC red

Beacon design parameters

(optimal mounting alignment)

Category O

O - 4.1 - 2.2 - 3.2 / V = 28.9 m³

Category O is designed as a cuboid.

Design legend:

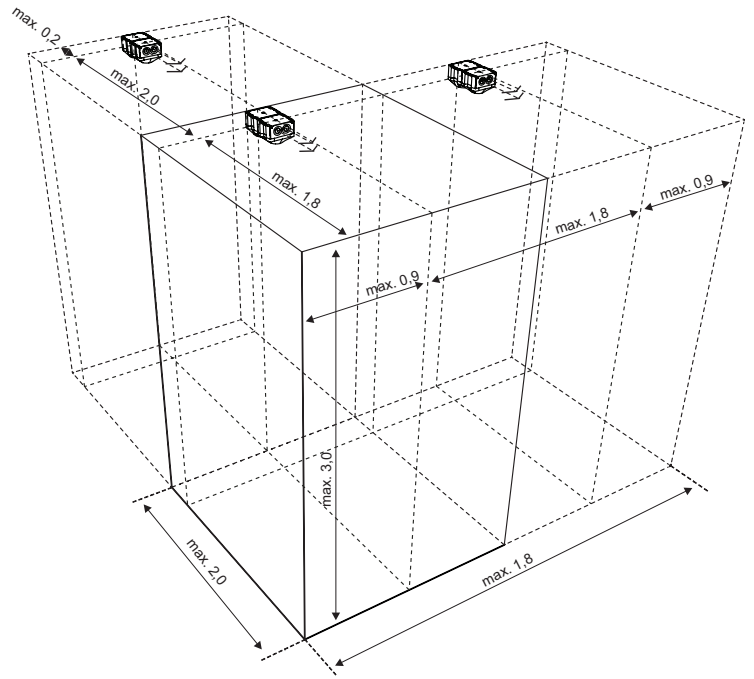

Example ceiling mounting (Dimensions in m)

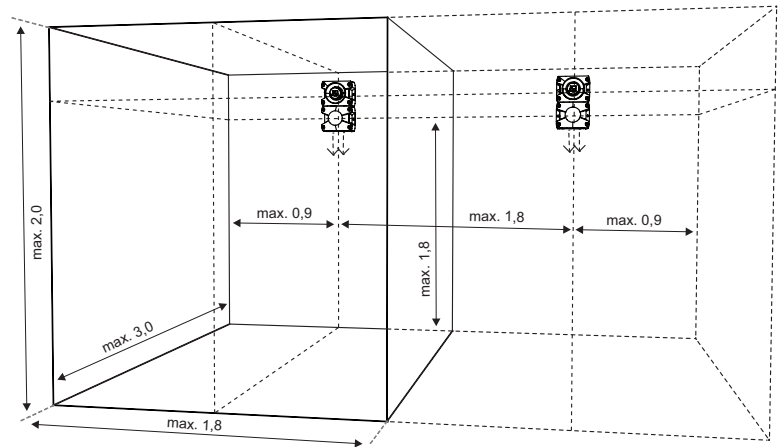

Example wall mounting (Dimensions in m)

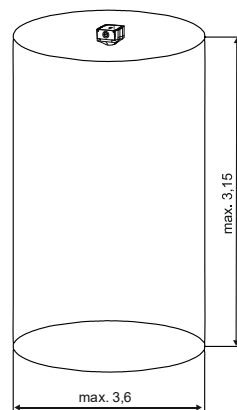

Category C (derived from category O)

C - 3.15 - 3.6 / V = 32 m³

Category C is designed as a cylinder.



Notification devices

Audible / visual

Sounder / Beacon PA X-1-05-SSM 24 DC clear



Technical specifications

Dome material	PC, clear
Enclosure material	PC / ABS Blend, red
Approved categories according EN 54-23	O
Flash technology	Xenon
Flash color	clear
IP rating	IP 66
Operating temperature	-40 °C to +55 °C (-40 °F to +131 °F)
Relative humidity	approx. 90 %
Operating voltage	18 V - 30 V DC
Rated current consumption: ¹⁾	
Beacon	300 mA (at 24 V DC / 1 Hz)
Sounder	38 mA (at 24 V / DIN-tone)
Current consumption max. (acc. to UL):	
Beacon	360 mA (at 24 V DC)
Sounder	70 mA (at 24 V DC)
Power consumption ¹⁾	approx. 8.1 W
Power consumption max. (acc. to UL)	11.5 W
Luminous intensity	55 cd
Flash energy	5 Joule
Flash rate	1 Hz = 60 flashes / min.
Tones	80
Tone stages	3 additional ext. selectable
Sound level	max. 105 dB (A) / 1 m
Weight	560 g (1.23 lbs)
Dimensions	109.5 x 172.4 x 80.6 mm (WxHxD) 4.31 x 6.79 x 3.17 inch (WxHxD)

¹⁾ The manufacturer's technical documentation exclusively lists the data according to UL specifications. In some cases, these deviate significantly from the values to be expected in reality.

Part no.: 914145

Audible/visual notification device in clear color for signaling fire hazards, approved according to EN 54-3, EN 54-23 and VdS. The sounder/beacon is impressive due to its safe and simple mounting with external lugs or internal holes, simple electrical connection on the bottom of the casing. The sounder/beacon is impact-proof. Equipped with an electronic soft start module for operation directly on a primary control group of the fire alarm panel via a voltage increase.

Included in delivery

1 Sounder / Beacon PA X-1-05-SSM 24 DC clear

Not included in delivery

Mounting hardware
Cable glands

Connection / mounting

Recommended cable 2-wire
Conductor cross-section max. 2.5 mm² (AWG 13)

Note

The combination unit has three pre-cut cable openings. The device can be operated via the voltage increase function as well as via the voltage reversal function. The device has an integrated reverse polarity protection diode.

Approvals / marking



G 212188



0786-CPD-21220



Beacon design parameters

See next page

Sounder / Beacon PA X-1-05-SSM 24 DC clear

Approvals / marking



G 214120



0786-CPR-21434

Part no.: 920569

Otherwise like part no. 914145

Note

The device, without soft start module, can only be operated via the voltage reversal function.



Notification devices

Audible / visual

Sounder / Beacon PA X-1-05-SSM 24 DC clear

Beacon design parameters

(optimal mounting alignment)

Category O

O - 11.1 - 8.4 - 6.3 / V = 587.4 m³

Category O is designed as a cuboid.

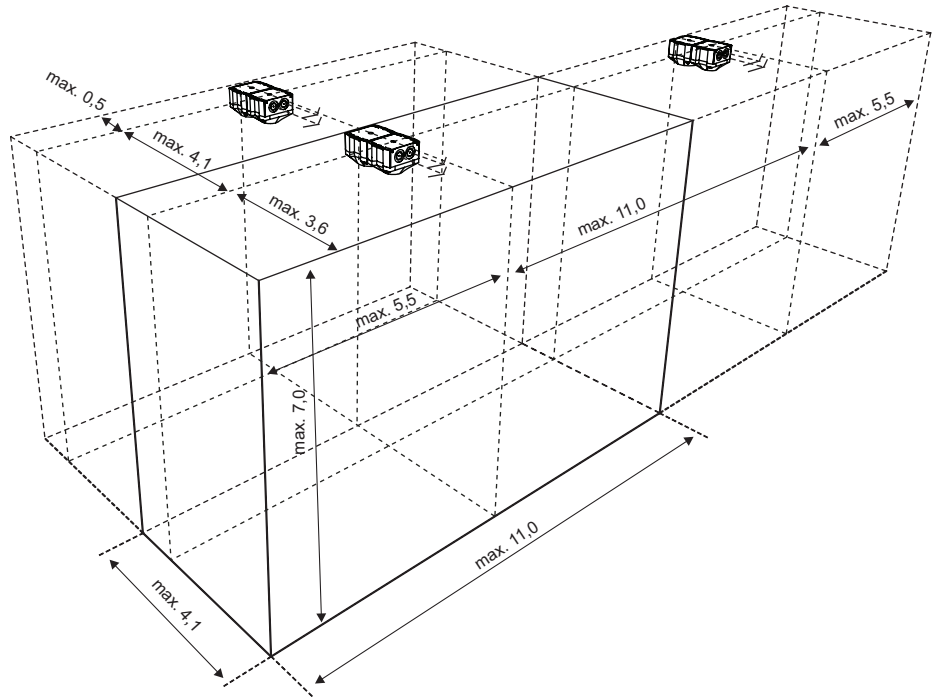

Example ceiling mounting (Dimensions in m)

Example wall mounting (Dimensions in m)

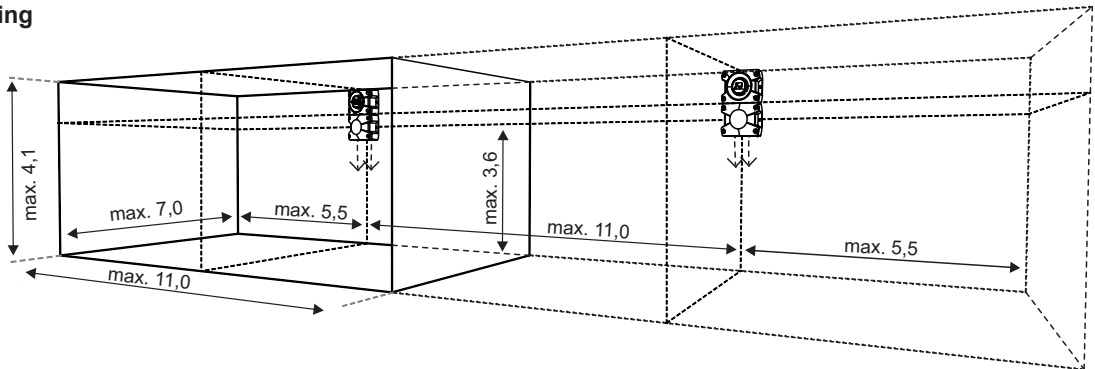

Category C (derived from category O)

C - 6.8 - 10.6 / V = 600 m³

Category C is designed as a cylinder.

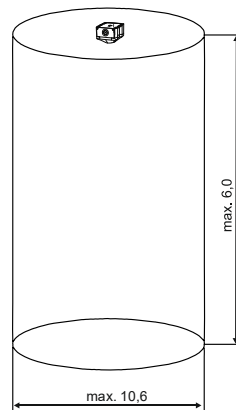



Notification devices

Audible / visual

Sounder / Beacon SONFL1X red



Part no.: 917453

Optical and audible notification device for signaling fire hazards. The combination unit can be mounted using external lugs or internal holes.

Technical specifications

Dome material	PC, red
Enclosure material	ABS, red
Flash technology	Xenon
Flash colour	red
Flash energy	5 Joule
IP rating	IP 66
Operating temperature	-25 °C to +55 °C (-13 °F to +131 °F)
Storage temperature	-40 °C to +70 °C (-40 °F to +158 °F)
Rated voltage	24 V DC
Operating temperature	20 V - 28 V DC
Rated current consumption	approx. 340 mA
Power consumption	8 W
Flash rate	1 Hz = 60 flashes / min.
Duty cycle	100 %
Tones	10
Sound pressure	to 100 dB (A) 1 m
Relative humidity	max. 90% at 20 °C (68 °F)
Weight	500 g (1.1 lbs)
Dimensions	114.6 x 172 x 84 mm (WxHxD) 4.5 x 6.8 x 3.3 inch (WxHxD)

Included in delivery

1 Sounder / Beacon SONFL1X red

Not included in delivery

Mounting hardware
Cable glands

Connection / mounting

Recommended cable 2-wires
Conductor cross-section 1.5 mm² (AWG 15)

Note

The device has three pre-cut M20 cable openings.
The device can only be operated via the voltage reversal function at the fire detection and suppression control panel FMZ 5000, FMZ 5000 mod S or Clunid.
The device has an integrated reverse polarity protection diode.

Approvals / marking



Notice!

This combination must not be used for alerting and evacuation of people in fire detection or gas extinguishing systems.
The device is not EN 54-23 or VdS approved.



Notification devices

Audible / visual

Sounder / Beacon SONFL1X clear



Technical specifications

Dome material	PC, clear
Enclosure material	ABS, red
Approved categories according EN 54-23	W
Flash technology	Xenon
Flash colour	clear
Flash energy	5 Joule
IP rating	IP 66
Operating temperature	-25 °C to +55 °C (-13 °F to +132 °F)
Storage temperature	-40 °C to +70 °C (-40 °F to +158 °F)
Rated voltage	24 V DC
Operating voltage	20 V - 28 V DC
Rated current consumption	approx. 340 mA
Power consumption	8 W
Flash rate	1 Hz = 60 flashes / min.
Duty cycle	100 %
Tones	10
Sound pressure	to 100 dB (A) 1 m
Relative humidity	max. 90% at 20 °C (68 °F)
Weight	500 g (1.1 lbs)
Dimensions	114.6 x 172 x 84 mm (WxHxD) 4.5 x 6.8 x 3.3 inch (WxHxD)

Beacon design parameters

Category W

W - 2.4 - 4.8 / V = 55.3 m³

Category W is designed as a cube.

Part no.: 917452

Optical and audible notification device for signaling fire hazards, approved according to EN 54-3, EN 54-23 and VdS in colour clear. The combination unit can be mounted using external lugs or internal holes.

Included in delivery

1 Sounder / Beacon SONFL1X clear

Not included in delivery

Mounting hardware
Cable glands

Connection / mounting

Recommended cable 2-wires
Conductor cross-section 1.5 mm² (AWG 15)

Note

The device has three pre-cut M20 cable openings. The device can only be operated via the voltage reversal function. The device has an integrated reverse polarity protection diode.

Approvals / marking



G 214028



0786-CPR-21348

Note approvals

This Sounder / beacon cannot be included in the VdS system approval of the, due to its technical parameters (minimum operation voltage)

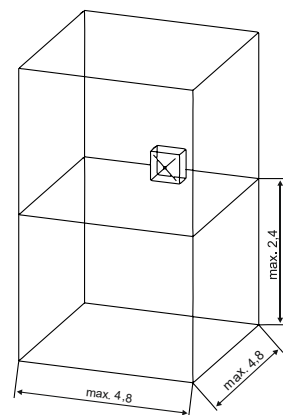



Notification devices

Audible / visual

Sounder / Beacon ROLP LX Wall red



Part no.: 917455

Optical and audible notification device for signaling fire hazards, approved according to EN 54-3 and EN 54-23 in category W. The flash rate and the high power or lower power application can be set using the DIP switch. The sounder volume is also set via the DIP switch.

Technical specifications

Enclosure material	ABS, red
Approved categories according EN 54-23	W
Flash technology	LED
Flash colour	red
IP rating	IP 65
Operating temperature	-25 °C to +70 °C (-13 °F to +158 °F)
Store temperature	-25 °C to +70 °C (-13 °F to +158 °F)
Rated voltage	24 V DC
Operating voltage	9 V - 28 V DC
Rated current consumption at 24 V DC	High Power 1 Hz: 55 mA High Power 0.5 Hz: 46 mA Low Power 1 Hz: 46 mA Low Power 0.5 Hz: 40 mA
Surge current	< 120 % for 10 ms
Flash sequence adjustable	0.5 Hz = 30 flashes / min. 1 Hz = 60 flashes / min.
Tones	32
Sound pressure	up to 102 dB (A) 1 m
Weight	200 g (0.4 lbs)
Dimensions	135 x 95 x 95 mm (WxHxD) 5.3 x 3.7 x 3.7 inch (WxHxD)

Design parameters

Category W

W - 2.4 - 7.5 / V = 135 m³ (high power)

W - 2.4 - 2.5 / V = 15 m³ (low power)

Category W is designed as a cube.

Included in delivery

1 Sounder / Beacon ROLP LX Wall red

Not included in delivery

Mounting hardware
Cable glands

Connection / mounting

Recommended cable 2-wires
Conductor cross-section 2.5 mm² (AWG 13)

Note

The device has two pre-cut M20 cable openings. The device can only be operated via the voltage reversal function. The device has an integrated reverse polarity protection diode.

Approvals / marking



G 214070
G 206019



0333-CPR-075444
0832-CPD-0128

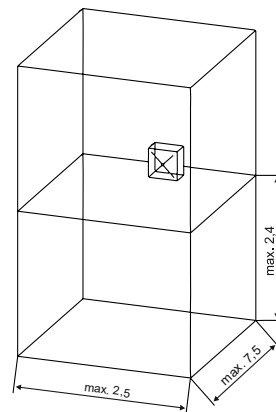



Notification devices

Audible / visual

Sounder / Beacon ROLP LX Wall clear

Part no.: 917454

Otherwise like part no. 917455



Technical specifications

Flash colour	clear
--------------	-------



Notification devices

Audible / visual

Sounder/Beacon P2RK



Product features

- Field-selectable:
 - Horn tone and volume via rotary switch
 - Candela setting via slide switch (15, 15/75, 30, 75, 95, 110, 115 cd)
- Compatible with Synchronization module MDL3R
- For outdoor use

Technical specifications

Enclosure material	PC, red
Flash technology	Xenon
Flash colour	white
IP rating	IP 56
IP rating (American NEMA Standard Publ. 250)	NEMA 4X
Operating temperature	-40 °C to +66 °C (-40 °F to +151 °F)
Relative humidity	10 to 93% no condensation
Rated voltage	24 V DC
Operating voltage	8 V - 33 V DC
Rated current consumption	66 - 229 mA depending on sound setting and candela
Luminous intensity	up to 115 cd (adjustable)
Flash rate	1 Hz = 60 flashes / min.
Tones	3
Tone stages	3
Sound pressure	up to 101 dB
Weight	525 g (1.2 lbs)
Dimensions	119 x 142 x 64 mm (WxHxD) 4.7 x 5.6 x 2.5 inch (WxHxD)

Part no.: 918431

Visual and audible notification device in clear colour for signaling fire hazards. This sounder/beacon is listed for ceiling or wall mounting. Compatible with Synchronization module MDL3R.

Included in delivery

1 Sounder/Beacon P2RK
1 Weatherproof back box

Not included in delivery

Synchronization module MDL3R 931853
Mounting hardware
End of line-resistor and diode

Connecting / mounting

Connection cable 2-wire
Conductor cross-section max. 3.3 mm² (AWG 12)

Note.

Distribution only to non-EU countries.

Approvals / marking





Notification devices

Audible / visual

Sounder/Beacon High Candela P2RHK

Part no.: 918433

Visual and audible notification device in clear colour for signaling fire hazards. This sounder/beacon is listed for ceiling or wall mounting. Compatible with Synchronization module MDL3R.

Product features

- High candela range
- Field-selectable:
 - Horn tone and volume via rotary switch
 - Candela setting via slide switch (135, 150, 177 or 185 cd)
- Compatible with Synchronization module MDL3R
- For outdoor use

Included in delivery

1 Sounder/Beacon High Candela P2RHK
1 Weatherproof back box

Not included in delivery

Synchronization module MDL3R 931853
Mounting hardware
End of line-resistor and diode

Technical specifications

Enclosure material	PC, red
Flash technology	Xenon
Flash colour	white
IP rating	IP 56
IP rating (American NEMA Standard Publ. 250)	NEMA 4X
Operating temperature	-40 °C to +66 °C (-40 °F to +150.8 °F)
Relative humidity	10 to 93% no condensation
Rated voltage	24 V DC
Operating voltage	16 V - 33 V DC
Rated current consumption	232 - 309 mA depending on sound setting and candela
Luminous intensity	up to 185 cd (adjustable)
Flash rate	1 Hz = 60 flashes / min.
Tones	3
Tone stages	3
Sound pressure	up to 101 dB
Weight	525 g (1.2 lbs)
Dimensions	119 x 142 x 64 mm (WxHxD) 4.7 x 5.6 x 2.5 inch (WxHxD)

Connecting / mounting

Connection cable 2-wire
Conductor cross-section max. 3.3 mm² (AWG 12)

Note.

Distribution only to non-EU countries.

Approvals / marking





Notification devices

Audible / visual

Horn Strobe P2RL



Product features

- Field-selectable from tone and volume via rotary switch
- Field-selectable candela settings via slide switch (15, 30, 75, 95, 110, 135 or 185 cd)
- For indoor use
- Impact resistant housing
- Compatible with Synchronization module MDL3R
- Simple installation due to separate mounting plate with integrated short-circuit spring

Technical specifications

Flash color	white
Rated voltage	12 V DC 24 V DC
Operating voltage	8 - 17.5 V (12 V) DC 16 - 33 V (24 V) DC
Operating voltage with MDL3 Sync module	8.5 - 17.5 V (12 V) DC 16.5 - 33 V (24 V) DC
Rated current consumption	44 - 262 mA depending on sound setting and volume level
Tones	4
Volume levels	2
Flash rate	1Hz = 60 flashes / min.
Operating temperature	0°C to +49°C (+32 °F to +120 °F)
Relative humidity	10 to 93% no condensation
Sound pressure	82 - 90 dB
Weight	360 g (0.8 lbs)
Dimensions	119 x 142 x 64 mm (WxHxD) 4.7 x 5.6 x 2.5 inch (WxHxD)

Part no.: 927476

Audible and optical notification device for signaling fire hazards. This horn strobe is listed for wall mounting in indoor areas. Compatible with Synchronization module MDL3R.

Included in delivery

- 1 Horn Strobe P2RL
- 1 Mounting plate

Not included in delivery

- Synchronization module MDL3R 931853
- Mounting hardware
- 1 End of line-resistor with diode

Connecting / mounting

- Recommended cable 2-wire
- Conductor cross-section max. 3.3 mm² (AWG 12)

Note

Distribution only to non-EU countries.

Approvals / marking





Notification devices

Audible / visual, addressable

Base sounder beacon BSBX 707



Technical specifications

Enclosure material	PC
Sound pressure	up to 85 dB
Color enclosure	white
Color ring flash light	klar
Integrated isolator	yes
Operating temperature	-20 °C to +60 °C (-4 °F to +140 °F)
Operating voltage	17 V - 28 V DC
Quiescent current at 24 V DC	350 µA
Current consumption at 24 V DC	max. 14 mA
Weight	168 g
Dimensions	115 x 38 mm (DxH)

Project planning

Coverage diagram

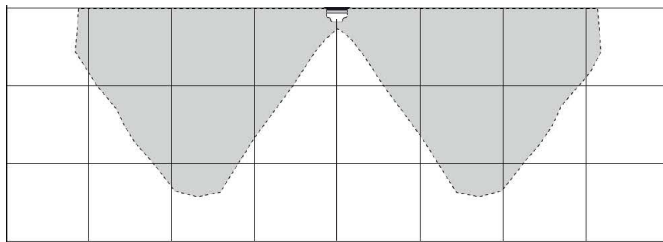

Cross section coverage range. 1 square represents 1m.

Part no.: 4006055

Base sounder beacon for Loop AP with integrated short-circuit isolator. Type A device for signaling indoor fire alarms with two volume ranges. Addressing is done via address card and the built-in DIP switches. The volume is adjusted via DIP switches.

Included in delivery

1 Base sounder beacon BSBX 707
1 Address card

Not included in delivery

Mounting material

Optional accessories

Cover base sounder ACX292 WH	912576
Cover base sounder ACX293 RD	912575
Mounting plate Sounder ACX 311	4003200

Connection / mounting

Cable recommendation standard	747180
J-Y(St)Y -2x2x0.8 mm, red	2-adrig
Recommended cable	max. 2.5 mm ² (AWG 13)
Conductor cross section	not required
Electrostatic shielding	

Note

The certification of the sounder according to EN 54-3 only applies when using the higher volume range. The reduced volume range is not approved for fire alarm systems. The beacon complies with EN 54-23 (category O). The integrated isolator complies with EN 54-17.

Approvals / marking



G 218092





Notification devices

Audible / visual

Synchronization module MDL3R



Part no.: 931853

Module for synchronizing flashing lights and horns of the HR*, SR*, P2* series (see note).

The module is intended for connection between the control group module of the fire detection panel and the alarm devices to be synchronized.

Product features

- Synchronization of flashing lights with a flash frequency of 1 Hz
- Synchronization of horns
- Cross-zone synchronization
- Combination of several synchronization modules (master/slave)

Included in delivery

- 1 Synchronization module MDL3R
- 1 Back box

Not included in delivery

Mounting material

Technical specifications

Operating voltage of notification devices in combination with MDL3R	8.5-17.5 (12 V) 16.5 -33 V DC (24 V)
Rated voltage	12 V DC 24 V DC
Rated current consumption	10 mA 12 mA
Current load max.	3 A
Operating temperature	0 °C to 49 °C (+32 °F to 120 °F)
Approvals	UL464, UL1971, ULC S525, ULC S526
Synchronized zones / devices	2
Weight	227 g (0.5 lbs)
Dimensions	133 x 133 mm (WxH) 5.2 x 5.2 inch (WxH)

Connection / mounting

Recommended cable

2-wire

Conductor cross-section:

2.5 mm² (AWG 13)

Note

Synchronization of the following notification devices:

Sounder HRL	927474
Sounder HRK	918425
Strobe SRL	927475
Beacon SRK	918427
Beacon SRHK	918429
Horn strobe P2RL	927476
Horn strobe P2RK	918431
Horn strobe P2RHK	918433

Approvals / marking



1/1 320-010_001 / A100 / 2019-Jan-01 / en The contents of this publication are subject to modifications without notice. All rights reserved.

Trusted above all.





Notification devices

Audible / visual, addressable

Loop Sounder / Beacon LSBX 005r WP



Part no.: 912574

Analogue addressable Loop Sounder / Beacon for acoustic and optical alarms with integrated dual isolator in red. Addressing is done via integrated DIP switches.

Technical specifications

Enclosure material	PC
IP rating	IP 65
Technology / protocol	Loop AP / XP95
Sound pressure	up to 100 db
Enclosure colour	red
Spherical cup colour	red
Integrated isolator	yes
Operating temperature	-20 °C to +60 °C (-4 °F to +140 °F)
Operating voltage	17 V - 28 V DC
Operating current siren	8 mA
Rated current consumption	333 µA
Weight	260 g (0.57 lbs)
Dimensions	104 x 97.5 mm (dia.xH) 4.09 x 3.84 inch (dia.xH)

Included in delivery

1 Loop Sounder / Beacon LSBX 005r WP

Not included in delivery

Mounting hardware

Connection / mounting

Cable recommendation standard

J-Y(St)Y -2x2x0.8 mm, red

Recommended cable

Conductor cross-section

Electrostatic shielding

747180

2-wire

max. 2.5 mm² (AWG 13)

not required

Approvals / marking



Notice!

This combination must not be used for alerting and evacuation of people in fire detection or gas extinguishing systems.

The device is not EN 54-23 or VdS approved.



Notification devices

Audible / visual

LWA-90 red RNB lighted warning display



Technical specifications

Operating voltage	21 V - 29 V DC
Rated voltage	24 V DC
Rated current consumption	75 mA (continuous light) 55 mA (flashing) +10 mA (for buzzer)
Light colour	red
Light surface	240 x 90 mm (WxH) 9.4 x 3.5 inch (WxH)
Operating temperature	-40 °C to +85 °C (-40 °F to +104 °F)
Enclosure material	Aluminium, black
IP rating	IP 50
Weight	993 g (2.2 lbs)
Dimensions	300 x 120 x 35 mm (WxHxD) 11.8 x 4.7 x 1.4 inch (WxHxD)

Part no.: 910178

Illuminated warning display with super bright LEDs in a profile aluminium housing with RNB standard text on the reverse side of printed front window and two end caps for lateral cable insertion. Very bright and homogeneous illumination of the printed surface via use of a light guide body and laterally radiating super bright LEDs. The light display can be configured to flashing or continuous light via DIP switch and the built-in buzzer turned on or off.

Product features

- Standard text, „Achtung! Raum nicht betreten Löschung ausgelöst“ (RNB)
- The warning display is maintenance-free
- DIP switch for configuring continuous or flashing light
- Buzzer activation (approx. 70 dB)
- Optional relay contact to activate an external signal generator

Included in delivery

1 LWA-90 lighted warning display, red RNB, without mounting hardware

Approvals / marking



LWA-90 IP 54 red RNB lighted warning display

Technical specifications

Weight	1000 g (2.2 lbs)
--------	------------------

Part no.: 911746

IP rating IP 54
Otherwise like part no. 910178



Notification devices

Audible / visual

LWA-90 red RV lighted warning display



Technical specifications

Operating voltage	21 V - 29 V DC
Rated voltage	24 V DC
Rated current consumption	75 mA (continuous light) 55 mA (flashing) +10 mA (for buzzer)
Light colour	red
Light surface	240 x 90 mm (WxH) 9.4 x 3.5 inch (WxH)
Operating temperature	-40 °C to +85 °C (-40 °F to +104 °F)
Enclosure material	Aluminium, black
IP rating	IP 50
Weight	993 g (2.2 lbs)
Dimensions	300 x 120 x 35 mm (WxHxD) 11.8 x 4.7 x 1.4 inch (WxHxD)

Part no.: 910179

Illuminated warning display with super bright LEDs in a profile aluminium housing with RV standard text on the reverse side of printed front window and two end caps for lateral cable insertion. Very bright and homogeneous illumination of the printed surface via use of a light guide body and laterally radiating super bright LEDs. The light display can be configured to flashing or continuous light via DIP switch and the built-in buzzer turned on or off.

Product features

- Standard text „Achtung! Raum verlassen Löschung ausgelöst“ (RV)
- The warning display is maintenance-free
- DIP switch for configuring continuous or flashing light
- Buzzer activation (approx. 70 dB)
- Optional relay contact to activate an external signal generator

Included in delivery

1 LWA-90 lighted warning display, red RNB, without mounting hardware

Approvals / marking



LWA-90 IP 54 red RV lighted warning display

Technical specifications

Weight	1000 g (2.2 lbs)
--------	------------------

Part no.: 916293

IP rating IP 54
Otherwise like part no. 910179



Notification devices

Audible / visual

LWA-90 red RSV lighted warning display



Technical specifications

Operating voltage	21 V - 29 V DC
Rated voltage	24 V DC
Rated current consumption	75 mA (continuous light) 55 mA (flashing) +10 mA (for buzzer)
Light colour	red
Light surface	240 x 90 mm (WxH) 9.4 x 3.5 inch (WxH)
Operating temperature	-40 °C to +85 °C (-40 °F to +104 °F)
Enclosure material	Aluminium, black
IP rating	IP 50
Weight	993 g (2.2 lbs)
Dimensions	300 x 120 x 35 mm (WxHxD) 11.8 x 4.7 x 1.4 inch (WxHxD)

Part no.: 910180

Illuminated warning display with super bright LEDs in a profile aluminium housing with RSV standard text on the reverse side of printed front window and two end caps for lateral cable insertion. Very bright and homogeneous illumination of the printed surface via use of a light guide body and laterally radiating super bright LEDs. The light display can be configured to flashing or continuous light via DIP switch and the built-in buzzer turned on or off.

Product features

- Standard text „Achtung! Raum sofort verlassen Löschung ausgelöst“ (RSV)
- The warning display is maintenance-free
- DIP switch for configuring continuous or flashing light
- Buzzer activation (approx. 70 dB)
- Optional relay contact to activate an external signal generator

Included in delivery

1 LWA-90 lighted warning display, red RSV, without mounting hardware

Approvals / marking



LWA-90 IP 54 red RSV lighted warning display

Technical specifications

Weight	1000 g (2.2 lbs)
--------	------------------

Part no.: 916294

IP rating IP 54
Otherwise like part no. 910180



Notification devices

Audible / visual

LWA-90 red KT lighted warning display



Technical specifications

Operating voltage	21 V - 29 V DC
Rated voltage	24 V DC
Rated current consumption	75 mA (continuous light) 55 mA (flashing) +10 mA (for buzzer)
Light colour	red
Light surface	240 x 90 mm (WxH) 9.4 x 3.5 inch (WxH)
Operating temperature	-40 °C to +85 °C (-40 °F to +104 °F)
Enclosure material	Aluminium, black
IP rating	IP 50
Weight	993 g (2.2 lbs)
Dimensions	300 x 120 x 35 mm (WxHxD) 11.8 x 4.7 x 1.4 inch (WxHxD)

Part no.: 910181

Illuminated warning display with super bright LEDs in a profile aluminium housing with optional custom text on the reverse side of printed front window and two end caps for lateral cable insertion. Very bright and homogeneous illumination of the printed surface via use of a light guide body and laterally radiating super bright LEDs. The light display can be configured to flashing or continuous light via DIP switch and the built-in buzzer turned on or off.

Product features

- Custom text: Any text or graphic can be chosen!
- The warning display is maintenance-free
- DIP switch for configuring continuous or flashing light
- Buzzer activation (approx. 70 dB)
- Optional relay contact to activate an external signal generator

Included in delivery

1 LWA-90 lighted warning display, red KT, without mounting hardware

Approvals / marking



LWA-90 IP 54 red KT lighted warning display

Technical specifications

Weight	1000 g (2.2 lbs)
--------	------------------

Part no.: 911747

IP rating IP 54
Otherwise like part no. 910181



Notification devices

Audible / visual

LWA-130 red KT lighted warning display



Technical specifications

Operating voltage	21 V - 29 V DC
Rated voltage	24 V DC
Rated current consumption	75 mA (continuous light) 55 mA (flashing) +10 mA (for buzzer)
Light colour	red
Light surface	240 x 130 mm (WxH) 9.4 x 3.5 inch (WxH)
Operating temperature	-40 °C to +85 °C (-40 °F to +104 °F)
Enclosure material	Aluminium, black
IP rating	IP 50
Weight	1395 g (3.1 lbs)
Dimensions	346 x 166 x 35 mm (WxHxD) 13.6 x 6.5 x 1.4 inch (WxHxD)

Part no.: 910182

Illuminated warning display with super bright LEDs in a profile aluminium housing with optional custom text on the reverse side of printed front window and two end caps for lateral cable insertion. Very bright and homogeneous illumination of the printed surface via use of a light guide body and laterally radiating super bright LEDs. The light display can be configured to flashing or continuous light via DIP switch and the built-in buzzer turned on or off.

Product features

- Custom text: Any text or graphic can be chosen!
- The warning display is maintenance-free
- DIP switch for configuring continuous or flashing light
- Buzzer activation (approx. 90 dB)
- Optional relay contact to activate an external signal generator

Included in delivery

1 LWA-130 lighted warning display, red KT,
without mounting hardware

Approvals / marking



LWA-130 IP 54 red KT lighted warning display

Technical specifications

Weight	1403 g (3.09 lbs)
--------	-------------------

Part no.: 911748

IP rating IP 54
Otherwise like part no. 910182



Notification devices

Audible / visual

V2A base for LWA-90/-130

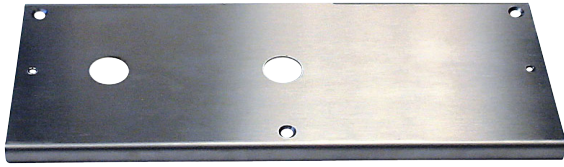

Part no.: 910185

For preassembly of the LWA-90/-130 lighted warning displays.

Technical specifications

Material	V2A
Dimensions	280 x 110 x 11 mm (WxHxD) 11 x 4.3 x 0.4 inch (WxHxD)

Included in delivery

- 1 Base V2A
- 3 Countersunk screws and dowels
- 2 Screws M4 x 20 mm

V2A head cover for LWA-90/-130

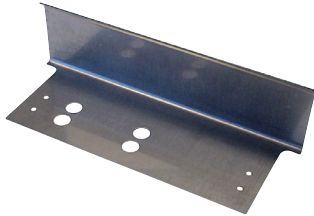

Part no.: 910184

Weather protection for the LWA-90/-130 lighted warning displays.

Technical specifications

Material	V2A
Weight	760 g (1.7 lbs)
Dimensions	340 (cover), 300 (rear panel) x 120 x 95 mm (WxHxD) 13.4 (cover), 11.5 (rear panel) x 4.7 x 3.7 inch (WxHxD)

Included in delivery

V2A head cover without mounting hardware

IP 65 LWA-90 weatherproof housing



Part no.: 910186

Weatherproof housing of transparent acrylic for use of LWA-90 lighted warning display. Consisting of rear panel and housing upper part, preassembled base bottom section for receiving the lighted warning display.

Technical specifications

Enclosure material	Acryl
Weight	1895 g (4.2 lbs)
Dimensions	350 x 150 x 65 mm (WxHxD) + overhang 40 mm 13.8 x 5.9 x 2.6 inch (WxHxD) + overhang 1.6 inch

Included in delivery

IP 65 housing without mounting hardware



Notification devices

Audible / visual

IP 65 LWA-130 weatherproof housing

Part no.: 910187

Technical specifications

Weatherproof housing of transparent acrylic for use of LWA-130 lighted warning display.

Otherwise like part no.: 910186

Weight	2459 g (5.4 lbs)
Dimensions	400 x 200 x 65 mm (WxHxD) + overhang 40 mm 15.8 x 7.9 x 2.6 inch (WxHxD) + overhang 1.6 inch



Notification devices

Audible / visual, Ex

Sounder / Beacon YL60 MX Ex



Product features

- Explosion-proof device for hazardous zone 1, 2, 21 and 22
- Max. 110 dB (A) / 1 m omnidirectional sound output
- 32 standardized tone sequences selectable
- 2-stage alarm, independently selectable 2nd stage
- Tone selection via DIP switch
- Fitted as standard with protective cage

Technical specifications

Spherical calotte material	PC, red
Horn material	ABS, red
Enclosure material	Aluminium, red
IP rating	IP 66
Operating temperature	-35 °C to +60 °C (T4 / T135°C) (-31 °F to +140 °F (T4 / T135°C)) -35 °C to +40 °C (T6 / T85°C) (-31 °F to +104 °F (T6 / T85 °C))
Storage temperature	-35 °C to +60 °C (-31 °F to +140 °F)
Rated voltage	24 V DC
Operating voltage	18 V - 30 V DC
Rated current consumption	approx. 570 mA
Power consumption	13.7 W
Flash energy	5 J
Flash rate	1 Hz = 60 flashes / min.
Tones	32
Sound pressure	up to 110 dB (A) 1 m
Relative humidity	max. 95%
Weight	6000 g (13.2 lbs)
Dimensions	420 x 145 mm (HxD) 16.5 x 5.7 inch (HxD)

Part no.: 910657

Audible and visual alarm device for signaling danger of fire that is especially suitable for use in industrial environments with hazard areas in zone 1, 2, 21 and 22. Equipped with electronic module for operation directly on a primary control group of the fire alarm panel via a voltage increase. The robust aluminium housing is resistant to sea water, environmental effects and chemicals.

Included in delivery

- 1 Sounder / Beacon YL60 MX Ex
- 1 Dust cover
- 1 Blanking plug

Not included in delivery

Mounting hardware

Connection / mounting

Recommended cable 2-wire
Conductor cross-section: 2.5 mm² (AWG 13)

Note

The combination unit can be operated via the voltage increase function as well as via the voltage reversal function. The device has an integrated reverse polarity protection diode.

Approvals / marking

Ex classification: Ex II 2G Ex d IIB T4 Ta -35°C to +60°C Gb
 Ex II 2G Ex d IIB T6 Ta -35°C to +40°C Gb
 Ex II 2D Ex tb IIIC T135°C Ta -35°C to +60°C Db IP 66
 Ex II 2D Ex tb IIIC T85°C Ta -35°C to +40°C Db IP 66





Gas detection

Chapter 11



Gas detection

Gas detection

Carbon dioxide warning device CO₂



Product features

- CO₂ controller with potential free contacts for pre-alarm, main alert and disorder
- Thresholds 1.5 and 3.0 Vol % CO₂
- Integrated buzzer and concentration indicator

Technical specifications

Power supply DC	24 V Reverse polarity protected
Max. Power consumption DC at 24 V	60 mA (1.5 VA)
3 Potential-free change-over contacts	250 V AC, 5A
2 x Transistor outputs	24 V DC / 0,1 A (plus switching)
Conductor cross-section digital-input, analog-output	min. 0.25, max. 1.3 mm ²
Conductor cross-section power supply relay	min. 0.25, max. 2.5 mm ²
Operating temperature	-25 °C to +50 °C (-13 °F to +122 °F)
Ambient temperature	+5 °C to +30 °C (+41 °F to + 86 °F)
Relative humidity	15 to 95 % no condensation
IP rating	IP 65
Material	Polycarbonate, RAL 7032 (light grey) UL94 V2
Weight	max. 600 g (1.3 lbs)
Dimensions	130 x 130 x 75 mm (WxHxD) 5.1 x 5.1 x 3.0 Inch (WxHxD)

Part no.: 924348

Gas detection and alarm controller monitoring areas with possible leakage of carbon dioxide. The alarm controller can also be used in CO₂ extinguishing systems, during and after the extinguishing and in rooms next to the extinguishing zone. The alarm relays are activated if the measured values exceed the pre-set thresholds for the pre-alarm or main alert. The relay is fail-safe.

Included in delivery

Carbon dioxide warning device
Sensor SC2 CO₂ 924371
Operating manual

Not included in delivery

Mounting hardware
Cable glands for the connection of external devices
For the functional check:
Calibration adapter C2-Z4 924370
Test gas abstraction unit 902932
Test gas cylinder (3.0 Vol %) 909523
Test gas cylinder (3.3 Vol %) 909524

Optional accessories

PC-calibration tool gas detector PCE06-PG2-PF 924372

Approvals / marking





Gas detection

Gas emission detectors

GMX1001CO I



Product features

- A microcontroller monitors the functionality and values
- Multi sensor carbon monoxide and temperature
- Connection of remote indicator possible

Technical specifications

Detection method	CO (carbon monoxide) and temperature
Alarm threshold:	≥ 40 ppm
- Carbon monoxide	> 60 °C (140 °F)
- Temperature	dT > 3 °C/min. at T > 36 °C (96,8 °F)
- Rate of rise measurement	
Operating voltage	7,6 V - 40 V DC
Quiescent current	approx. 0.15 mA
Alarm current	approx. 18 mA
Alarm indication	1 LED red
Electrostatic shielding	required
Operating temperature	-20 °C to +50 °C (-4 °F to +122 °F)
IP rating (EN 60529)	IP 65
Enclosure material	Diecast aluminum, RAL 5009-blue
Relative humidity	max. 15 to +90 % no condensation
Specification according to	EN 54-5
Weight	480 g (1.1 lbs)
Dimensions	122 x 80 x 69 mm (WxHxD) 4.8 x 3.2 x 2.7 inch (WxHxD)

Part no.: 900960

Multi sensor fire gas detector GMX1001CO I for the early detection of smoldering fires. Designed for use in rough industrial environments (e.g. silos, chip bunkers). The GMX1001CO I detects the burning characteristic substance carbon monoxide and temperature. False alarms are nearly impossible. Equipped for operation as a conventional detector.

Not included in delivery

Mounting device bracket with insulation	801284
Mounting device console 80x75 Ø54	902898
End of line-resistor 1.8 K / 0,5 W	675235
Test device smoke generator RG2000	902671
Remote indicator LMX5000	908499

Connection / mounting

Connection cable standard detector	2-wire
Conductor cross-section	max. 2.5 mm ² (AWG 13)
Fire detection cable with static shield	606061
LIYCY grey	5x0.5 mm ² (AWG 20)
Cable gland	M16x1.5, Brass nickel-plated, EMV

Spare parts

Screwed mounting GMX1001COI complete	902923
Sensor GMX1002CO	900968

Note

Simple one-man calibration

Approvals / marking



G 204121



0786-CPR-21781

GMX1001CO 300ppm

Special detector for application in areas with emissions of carbon monoxide increased due to operating conditions.

Technical specifications

Response monoxide	≥ 300 ppm
- Carbon monoxide	> 100 °C (212 °F)
- Temperature	dT > 3 °C/min. at T > 80 °C (176 °F)
- Differential measurement	

Part no.: 909139

Approvals / marking





Gas detection

Gas emission detector

GMX1001CO I BG

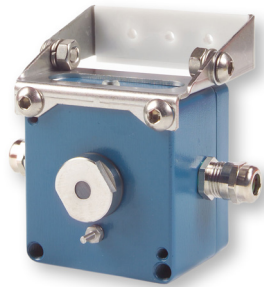

Product features

- A microcontroller monitors the functionality and values
- Multi sensor carbon monoxide and temperature
- Connection of remote indicator possible

Technical specifications

Detection method	CO (carbon monoxide) and temperature
Alarm threshold:	≥ 40 ppm
- Carbon monoxide	> 60 °C (140 °F)
- Temperature	dT > 3 °C/min. at T
- Rate of rise measurement	> 36 °C (96,8 °F)
Operating voltage	7.6 V - 40 V DC
Quiescent current	approx. 0.15 mA
Alarm current	approx. 18 mA
Alarm indication	1 LED red
Electrostatic shielding	required
Operating temperature	-20 °C to +50 °C (-4 °F to +122 °F)
IP rating (EN 60529)	IP 65
Enclosure material	Diecast aluminum, RAL 5009-blue
Relative humidity	max. 15 to +90 % no condensation
Specification according to	EN 54-5
Weight	600 g (1.3 lbs)
Dimensions	122 x 106 x 88 mm (WxHxD) 4.8 x 4.2 x 3.5 inch (WxHxD)

GMX1001CO 300ppm BG

Special detector for application in areas with emissions of carbon monoxide increased due to operating conditions.

Technical specifications

Response values	≥ 300 ppm
- Carbon monoxide	> 100 °C (212 °F)
- Temperature	dT > 3 °C/min. at T
- Differential measurement	> 80 °C (176 °F)

Part no.: 902891

Multi sensor fire gas detector GMX1001CO I BG for the early detection of smoldering fires. Designed for use in rough industrial environments (e.g. silos, chip bunkers). The GMX1001CO I detects the burning characteristic substance carbon monoxide and temperature. False alarms are nearly impossible. Designed for operation as a conventional detector.

Not included in delivery

Mounting device console 80x75 Ø54	902898
End of line-resistor 1.8 K / 0.5 W	675235
Test device smoke generator RG2000	902671
Remote indicator LMX5000	908499

Connection / mounting

Connection cable standard detector	2-wire
Conductor cross-section	max. 2.5 mm ² (AWG 13)
Fire detection cable with static shield	606061
LIYCY grey	5x0.5 mm ² (AWG 20)
Cable gland	M16x1.5, Brass nickel-plated, EMV

Spare parts

Screwed mounting GMX1001COI complete	902923
Sensor GMX1002CO	900968

Note

Simple one-man calibration

Approvals / marking



G 204121



0786-CPR-21781

Part no.: 909161

Approvals / marking





Gas detection

Gas emission detector

GMX1001CO I Console

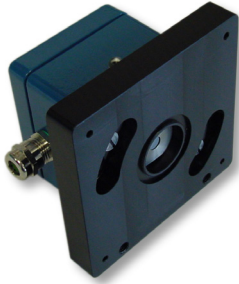

Product features

- A microcontroller monitors the functionality and values
- Multi sensor carbon monoxide and temperature
- Connection of remote indicator possible

Technical specifications

Detection method	CO (carbon monoxide) and temperature
Alarm threshold:	
- Carbon monoxide	≥ 40 ppm
- Temperature	> 60 °C (140 °F)
- Rate of rise measurement	dT > 3 °C/min. at T > 36 °C (96.8 °F)
Operating voltage	7.6 V - 40 V DC
Quiescent current	approx. 0.15 mA
Alarm current	approx. 18 mA
Alarm indication	1 LED red
Electrostatic shielding	required
Operating temperature	-20 °C to +50 °C (-4 °F to +122 °F)
IP rating (EN 60529)	IP 65
Enclosure material	Diecast aluminum, RAL 5009-blue
Relative humidity	max. 15 to +90 % no condensation
Weight	600 g (1.3 lbs)
Dimensions	122 x 112 x 75 mm (WxHxD) 4.8 x 4.4 x 3 inch (WxHxD)

GMX1001CO 300ppm Console

Special detector for application in areas with emissions of carbon monoxide increased due to operating conditions.

Technical specifications

Response values	≥ 300 ppm
- Carbon monoxide	> 100 °C (212 °F)
- Temperature	dT > 3 °C/min. at T > 80 °C (176 °F)
- Differential measurement	

Part no.: 902893

Multi sensor fire gas detector GMX1001CO I Console for the early detection of smoldering fires. Designed for use in rough industrial environments (e.g. silos, chip bunkers). Version bracket mount. The GMX1001CO I detects the burning characteristic substance carbon monoxide and temperature. False alarms are nearly impossible. Designed for operation as a conventional detector.

Not included in delivery

Mounting device bracket with insulation	801284
End of line-resistor 1.8 K / 0.5 W	675235
Test device smoke detector RG2000	902671
Remote indicator LMX5000	908499

Connection / mounting

Connection cable standard detector	2-wire
Conductor cross-section	max. 2.5 mm ² (AWG 13)
Fire detection cable with static shield	606061
LIYCY grey	5x0.5 mm ² (AWG 20)
Cable gland	M16x1.5, Brass nickel-plated, EMV

Spare parts

Screwed mounting GMX1001COI complete	902923
Sensor GMX1002CO	900968

Note

Simple one-man calibration

Approvals / marking



Trusted above all.

Viking GmbH | Industriestr. 10/12 | D-23840 Bad Oldesloe | www.viking-emea.com





Gas detection

Gas emission detector, Ex

GMX1001CO Ex Dust



Product features

- A microcontroller monitors the functionality and values
- Multi sensor carbon monoxide and temperature
- Connection of remote indicator possible
- For use in Ex zones 20, 21 and 22

Technical specifications

Detection method	CO (carbon monoxide) and temperature
Alarm threshold	≥ 40 ppm
- Carbon monoxide	> 60 °C (140 °F)
- Temperature	dT > 3 °C/min. at T
- Rate of rise measurement	> 36 °C (96.8 °F)
Number of detectors per line	max. 32
Operating voltage	7.6 V - 40 V DC
Quiescent current	approx. 0.15 mA
Alarm current	approx. 18 mA
Alarm indication	1 LED red
Electrostatic shielding	required
Operating temperature	-20 °C to +50 °C (-4 °F to +122 °F)
IP rating (EN 60529)	IP 65
Enclosure material	Diecast aluminum, RAL 5009-blue
Relative humidity (IEC 721-3-3)	max. 15 to + 90 % no condensation
Specification according to	EN 54-5
Weight	480 g (1.1 lbs)
Dimensions	122 x 80 x 69 mm (WxHxD) 4.8 x 3.2 x 2.7 inch (WxHxD)

Part no.: 905642

Multi sensor fire gas detector GMX1001CO Ex Dust for the early detection of smoldering fires. Designed for use in rough industrial environments (e.g. silos, chip bunkers). The GMX1001CO I detects the burning characteristic substance carbon monoxide and temperature. False alarms are nearly impossible. Designed for operation as a conventional detector. The GMX1001CO Ex Dust gas detectors are ATEX-approved for category 1 and 2 dust and are suitable for use in Ex zone 20 and 21.

Not included in delivery

Mounting device bracket with insulation	801284
Mounting device console 80x75Ø54	902898
End of line-resistor 1.8 K / 0.5 W	675235
Test device smoke generator RG2000	902671
Remote indicator LMX5000	908499

Connection / mounting

Connection cable standard detector	2-wire
Conductor cross-section	max. 2.5 mm ² (AWG 13)
Fire detection cable with static shield	606061
LIYCY grey	5x0.5 mm ² (AWG 20)
Cable gland	M16x1.5, Brass nickel-plated, EMV, Ex

Spare parts

Screwed GMX1001COI complete	902923
Sensor GMX1002CO	900968

Note

Simple one-man calibration

Approvals

Type examination certificate: BVS 05 ATEX E179

Approvals / marking



G 204121



0786-CPR-21781





Gas detection

Gas emission detector, Ex

GMX1001CO Ex Dust BG

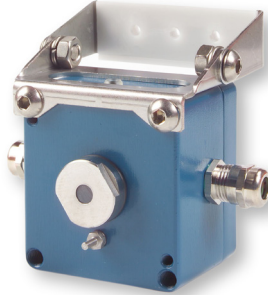

Product features

- A microcontroller monitors the functionality and values
- Multi sensor carbon monoxide and temperature
- Connection of remote indicator possible
- For use in Ex zones 20, 21 and 22

Technical specifications

Detection method	CO (carbon monoxide) and temperature
Alarm threshold	≥ 40 ppm
- Carbon monoxide	> 60 °C (140 °F)
- Temperature	dT > 3 °C/min. at T > 36 °C (96.8 °F)
- Rate of rise measurement	
Operating voltage	7.6 V - 40 V DC
Quiescent current	approx. 0.15 mA
Alarm current	approx. 18 mA
Alarm indication	1 LED red
Electrostatic shielding	required
Operating temperature	-20 °C to +50 °C (-4 °F to +122 °F)
IP rating (EN 60529)	IP 65
Enclosure material	Diecast aluminum, RAL 5009-blue
Relative humidity (IEC 721-3-3)	max. 15 to + 90 % no condensation
Specification according to	EN 54-5
Weight	600 g (1.3 lbs)
Dimensions	122 x 106 x 88 mm (WxHxD) 4.8 x 4.2 x 3.5 inch (WxHxD)

Part no.: 905643

Multi sensor fire gas detector GMX1001CO Ex Dust BG for the early detection of smoldering fires. Designed for use in rough industrial environments (e.g. silos, chip bunkers). The GMX1001CO I detects the burning characteristic substance carbon monoxide and temperature. False alarms are nearly impossible. Designed for operation as a conventional detector. The GMX1001CO Ex Dust BG gas detectors are ATEX-approved for category 1 and 2 dust and are suitable for use in Ex zone 20 and 21.

Not included in delivery

Mounting device console 80x75Ø54	902898
End of line-resistor 1.8 K / 0.5 W	675235
Test device smoke generator RG2000	902671
Remote indicator LMX5000	908499

Connection / mounting

Connection cable standard detector	2-wire
Conductor cross-section	max. 2.5 mm ² (AWG 13)
Fire detection cable with static shield	606061
LIYCY grey	5x0.5 mm ² (AWG 20)
Cable gland	M16x1.5, Brass nickel-plated, EMV, Ex

Spare parts

Screwed GMX1001COI complete	902923
Sensor GMX1002CO	900968

Note

Simple one-man calibration

Approvals / marking

Type examination certificate: BVS 05 ATEX E179



G 204121



0786-CPR-21781





Gas detection

Gas emission detector, Ex

GMX1001CO Ex Dust Console

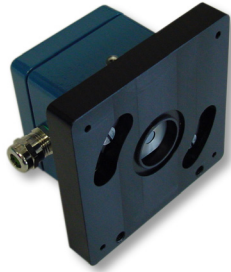

Product features

- A microcontroller monitors the functionality and values
- Multi sensor carbon monoxide and temperature
- Connection of remote indicator possible
- For use in Ex zones 20, 21 and 22

Technical specifications

Detection method	CO (carbon monoxide) and temperature
Alarm threshold	≥ 40 ppm
- Carbon monoxide	> 60 °C (140 °F)
- Temperature	dT > 3 °C/min. at T > 36 °C (96.8 °F)
- Rate of rise measurement	
Operating voltage	7.6 V - 40 V DC
Quiescent current	approx. 0.15 mA
Alarm current	approx. 18 mA
Alarm indication	1 LED red
Electrostatic shielding	required
Operating temperature	-20 °C to +50 °C (-4 °F to +122 °F)
IP rating (EN 60529)	IP 65
Enclosure material	Diecast aluminum, RAL 5009-blau
Relative humidity (IEC 721-3-3)	max. 15 to + 90 % no condensation
Weight	600 g (1.3 lbs)
Dimensions	122 x 112 x 75 mm (WxHxD) 4.8 x 4.4 x 3 inch (WxHxD)

Part no.: 905644

Multi sensor fire gas detector GMX1001CO Ex Dust Console for the early detection of smoldering fires. Designed for use in rough industrial environments (e.g. silos, chip bunkers). Version bracket mount. The GMX1001CO I detects the burning characteristic substance carbon monoxide and temperature. False alarms are nearly impossible. Equipped for operation as a conventional detector. The GMX1001CO Ex Dust Console gas detectors are ATEX-approved for category 1 and 2 dust and are suitable for use in Ex zone 20 and 21.

Not included in delivery

Mounting device bracket with insulation	801284
End of line-resistor 1.8 K / 0.5 W	675235
Test device smoke generator RG2000	902671
Remote indicator LMX5000	908499

Connection / mounting

Connection cable standard detector	2-wire
Conductor cross-section	max. 2.5 mm ² (AWG 13)
Fire detection cable with static shield	606061
LIYCY grey	5x0.5 mm ² (AWG 20)
Cable gland	M16x1.5, Brass nickel-plated, EMV, Ex

Spare parts

Screwed GMX1001COI complete	902923
Sensor GMX1002CO	900968

Note

Simple one-man calibration

Approvals / marking

Type examination certificate: BVS 05 ATEX E179

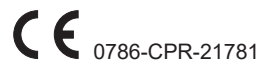

0786-CPR-21781





Door hold-open technology

Chapter 12



Door hold - open technology

Door hold - open technology

TSZ RZ-24 with integrated push button



Product features

- Potential-free contact for fire alarm
- Integrated buzzer
- Automatic door locking, opening of smoke dampers, disconnection of machines

Technical specifications

Operating temperature	-30 °C to +40 °C (-22 °F to +104 °F)
Operating voltage	85 V - 265 V AC
Power rating	approx. 30 W
Output voltage	24 V ±5 %
Output current	max. 0.9 A in total terminator 4.5 mA
Loop	Quiescent current at 4k7 Alarm > 12 mA Interruption > 3 mA
Relay contact voltage	0.8 A / 250 V AC
IP rating	IP 64
Enclosure material	Plastics
Weight	450 g (1.0 lbs)
Dimensions	122 x 122 x 55 mm (WxHxD) 4.8 x 4.8 x 2.2 inch (WxHxD)

Part no.: 931974

The magnetic door holder panel TSZ RZ-24 with integrated push button for manual release is intended for the control of classified fire doors, fire gates and fire dampers by means of hold-open devices. If a fire detector should detect smoke or heat or if a manual call point is activated, the TSZ RZ-24 interrupts the power supply to the holding solenoids immediately, and the fire doors are automatically closed by the door closer. Simultaneously, the relay contact opens and possibly connected signal devices or controls are activated.

Included in delivery

- 1 Door lock panel TSZ RZ-24
- 4 Cable glands M16

Note

Approved for use with following detectors:

Detector	Part no.	Approval (VdS)
Optical detector S65	901212	G200017
Opt. smoke detector OMX ORB	905567	G204039
Multisensor detector OWMX ORB	905566	G204040
Heat detector WMX ORB A1R	905565	G204033
Opt. smoke detector OMX ORB Ex	907160	G207027
Multisensor detector OWMX ORB Ex	907161	G207028
Heat detector WMX ORB A1R Ex	907162	G207020
Heat detector WMX5000	misc.	G207090

Approvals / marking

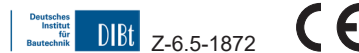

Z-6.5-1872



Door hold - open technology

Door hold - open technology

Magnetic clamp el. TSZ 24VDC

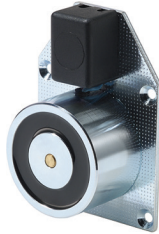

Technical specifications

Rated voltage	24 V DC
Rated current	63 mA
Wattage rating	1.5 W
Adhesive force	490 N
Operating temperature	0 °C to + 50 °C (+32 °F to +122 °F)
Storage temperature	-30 °C to +70 °C (-22 °F to +158 °F)
Duty cycle	100 %
Holding solenoid diameter	50 mm (2 inch)
IP rating	IP 65
Weight	400 g (0.9 lbs)
Dimensions	65 x 93 x 33 mm (WxHxD) 2.6 x 3.7 x 1.3 inch (WxHxD)

Part no.: 909327

The magnetic clamp with its base plate can be used for wall mounting. The standard electric connection occurs via double-pole terminals.

Product features

- Integrated reverse protection diode and suppressor diode

Approvals / marking



G 23097



0786-CPD-20249



Z-6.5-1441

Magnetic clamp el. TSZ 24VDC on-wall



Technical specifications

Rated voltage	24 V DC
Rated current	63 mA
Wattage rating	1.5 W
Adhesive force	490 N
Operating temperatur	0 °C to +50 °C (+32 °F to +122 °F)
Storage temperature	-30 °C to +70 °C (-22 °F to +158 °F)
Duty cycle	100 %
Holding solenoid diameter	50 mm (2 inch)
IP rating	IP 65
Weight	450 g (1 lbs)
Dimensions	85 x 105 x 37,5 mm (WxHxD) 3.4 x 4.1 x 1.5 inch (WxHxD)

Part no.: 909328

The magnetic clamp with its steel base plate in a closed housing is a surface-mount design and can be used for wall mounting. An interrupt button is integrated, and the electric connection is carried out from the rear side.

Product features

- Incorporated reverse protection diode and suppressor diode

Approvals / marking



G 23097



0786-CPD-20249



Z-6.5-1441



Door hold - open technology

Door hold - open technology

Anchor plate TSZ 55 mm with joint



Technical specifications

Operating temperature	0 °C to +50 °C (+32 °F to +122 °F)
Storage temperature	-30 °C to +70 °C (-22 °F to +158 °F)
Plate diameter	55 mm (2.2 inch)
Weight	130 g (0.3 lbs)
Dimensions	55 x 55 x 50 mm (WxHxD) 2.2 x 2.2 x 2 inch (WxHxD)

Part no.: 909412

Anchor plate with flexible connecting piece and hinged joint for establishing the magnetic connection between fire door and door holding solenoids. In general, the diameter of the anchor plate is slightly larger than that of the corresponding holding solenoid. Thus, mounting imprecision does not have any effect on the adhesive force.

Product features

- Pivoting in two directions up to 60°
- Fixable in any position

Push button TSZ on-wall mounted



Technical specifications

Operating temperature	-25°C to +40°C (-13 °F to +104°F)
Enclosure material	Plastics
IP rating	IP 20
Weight	84 g (0.19 lbs)
Dimensions	62 x 62 x 31 mm (WxHxD) 2.4 x 2.4 x 1.2 inch (WxHxD)

Part no.: 909413

Push-button with surface-mounted design for manual activation of locking systems with the inscription „Tür schließen!“.

Note

Only these push buttons are suitable for operation in locking systems according to DiBt.

Push button TSZ in-wall mounted



Technical specifications

Operating temperature	0°C to +50°C (+32 °F to +122 °F)
Enclosure material	Plastics
Weight	90 g (0.2 lbs)
Dimensions	81 x 81 x 10 mm (WxHxD) 3.2 x 3.2 x 0.04 inch (WxHxD)

Part no.: 909414

Push-button with flush-mounted design for manual activation of locking systems with the inscription „Tür schließen!“.

Note

Only these push buttons are suitable for operation in locking systems according to DiBt.



Door hold - open technology

Door hold - open technology

Magnetic clamp el. TSZ 24VDC 185 mm (7.3 inch)



Technical specifications

Rated voltage	24 V DC
Rated current	63 mA
Wattage rating	1.5 W
Adhesive force	490 N
Operating temperature	0 °C to +50 °C (+32 °F to +122 °F)
Storage temperature	-30 °C to +70 °C (-22 °F to +158 °F)
Duty cycle	100 %
Holding solenoid diameter	50 mm (2 inch)
IP rating	IP 65
Weight	820 g (1.8 lbs)
Dimensions	90 x 185 x 105 mm (WxHxD) 3.5 x 7.3 x 4.1 inch (WxHxD)

Part no.: 909329

Through modification the magnetic clamp can be used for wall, ceiling or floor mounting. The tube can be shortened to 110 and/or 145 mm (floor/wall mounting) so that almost any kind of distance between door and wall can be bridged.

Product features

- Incorporated reverse protection diode and suppressor diode

Approvals / marking



G 23097



0786-CPD-20249



Z-6.5-1441

Magnetic clamp el. TSZ 24VDC 335 mm (13.2 inch)

Technical specifications

Weight	900 g (2 lbs)
Dimensions	90 x 335 x 105 mm (WxHxD) 3.5 x 13.2 x 4.1 inch (WxHxD)

Part no.: 909330

Otherwise like part no. 909329

Anchor plate TSZ 55 mm (2.2 inch)



Technical specifications

Operating temperature	0 °C to +50 °C (+32 °F to +122 °F)
Storage temperature	-30 °C to +70 °C (-22 °F to +158 °F)
Plate diameter	55 mm (2.2 inch)
Weight	200 g (0.4 lbs)
Dimensions	55 x 55 x 18 mm (WxHxD) 2.2 x 2.2 x 0.7 inch (WxHxD)

Part no.: 909411

Anchor plate with flexible connecting piece for establishing the magnetic connection between fire door and door holding solenoid. In general, the diameter of the anchor plate is slightly larger than that of the corresponding holding solenoid. Thus, mounting imprecision does not have any effect on the adhesive force.

Product features

- Compensating inclination angle up to 5 °C (+41 °F)
- With rubber bearing



Cable/ installation material

Chapter 13



Cable/installation material

Cable/installation material

Cable J-Y(St)Y - 2x2x0.8 mm (0.03 inch) Ø, red



Technical specifications

Line resistance at 20 °C (68 °F)	≤ 36.6 Ohm / km (0.6 miles)
Isolating resistance at 20 °C (68 °F)	≥ 100 MOhm / km (0.6 miles)
Operating capacity at 800 Hz	≤ 120 nF / km (0.6 miles)
Capacitive couplings at 800 Hz	≤ 500 pF / km (0.6 miles)
Inductance at 800 Hz	approx. 0.7 mH / km (0.6 miles)
Operating voltage	≤ 300 V, not for high-voltage applications
Temperature range for fixed installation	-30 °C to +70 °C (-22 °F to +158 °F)
Temperature range for flexible installation	-5 °C to +50 °C (+23 °F to +123 °F)
Outer diameter	6 mm (0.2 inch)
Specification according to	VDE 0815
Weight	approx. 57 g / m (0.1 lbs / 39 inch)

Part no.: 747180

Fire alarm cable (red) for signal transmission in facilities in dry and moist plant locations. For installation inside and on wall.

Quantity unit for orders = meters

Included in delivery

1 Packaging unit (cable coil 200 m (0.12 miles))

Cable JE-H(St)H - 2x2x0.8 mm (0.03 inch) Ø, orange



Technical specifications

Line resistance at 20 °C (68 °F)	≤ 36.6 Ohm / km (0.6 miles)
Isolating resistance at 20 °C (68 °F)	≥ 100 MOhm / km (0.6 miles)
Operating capacity at 800 Hz	≤ 120 nF / km (0.6 miles)
Capacitive couplings at 800 Hz	≤ 200 pF / 100m (0.06 miles)
Inductance at 800 Hz	approx. 0.7 mH / km (0.6 miles)
Operating voltage	≤ 225 V, not for high-voltage applications
Temperature range for fixed installation	-30 °C to +70 °C (-22 °F to +158 °F)
Temperature range for flexible installation	-5 °C to +50 °C (+23 °F to +122 °F)
Outer diameter	7.5 mm (0.3 inch)
Minimum bending radius	6 x cables Ø
Specification	according to VDE 0815
Weight	approx. 74 g / m (0.2 lbs / 39 inch)

Part no.: 907940

Fire alarm cable (orange) with E 30 circuit integrity for signal transmission in facilities in dry and moist plant locations. For installation in and on wall.

Fire detection in accordance with VDE 0482 Part 266-2, DIN EN 50266-2/ IEC 60332-3 (corresponds to DIN VDE 0472 Part 804 test method C).
E 30: circuit integrity in accordance with DIN 4102 Part 12

Leads are only stranded as star quad, not in pairs

Quantity unit for orders = meters

Included in delivery

1 Packaging unit (cable coil 100 m (0.06 miles))



Cable/installation material

Cable/installation material

Cable LiYCY - 5 x 0.5 mm² (AWG 20), shielded



Technical specifications

Line resistance at 20 °C (68 °F)	≤ 39 Ohm / km (0.6 miles)
Isolating resistance at 20 °C (68 °F)	≥ 20 MOhm / cm (0.4 inch)
Operating capacity - lead/lead	≤ 120 nF / km (0.6 miles)
- lead/shield	≤ 160 nF / km (0.6 miles)
Inductance	approx. 0.65 mH / km (0.6 miles)
Operating voltage	≤ 250 V, not for high-voltage applications
Temperature range for fixed installation	-30 °C to +80 °C (-22 °F to +176 °F)
Outer diameter	7 mm (0.3 inch)
Specification according to	VDE 0812
Weight	approx. 68 g / m (0.2 lbs / 39 inch)

Part no.: 606061

Data cable (grey)

Quantity unit for orders = meters

Included in delivery

1 Packaging unit (cable coil 100 m (0.06 miles))

Cable JE-Y(St)Y - 2x2x0.8 mm (0.03 inch) Ø, blue Ex

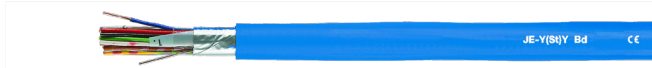

Technical specifications

Line resistance at 20 °C (68 °F)	≤ 36.6 Ohm / km (0.6 miles)
Isolating resistance at 20 °C (68 °F)	≥ 100 MOhm / km (0.6 miles)
Operating capacity	≤ 100 nF / km (0.6 miles)
Operating voltage	≤ 225 V, not for high-voltage applications
Temperature range for fixed installation	-30 °C to +70 °C (-22 °F to +158 °F)
Temperature range for flexible installation	-5 °C to +50 °C (-22 °F to +158 °F)
Outer diameter	6.6 mm (0.3 inch)
Minimum bending radius	6 x cables Ø
Specification according to	VDE 0815
Weight	approx. 60 g/m (0.1 lbs / 39 inch)

Part no.: 902674

Fire alarm cable (blue) for signal transmission in facilities in dry and moist plant locations. For installation in and on wall.

Quantity unit for orders = meters

Included in delivery

1 Packaging unit (cable coil 200 m (0.12 miles))



Cable/installation material

Cable/installation material

Cable OB-BL-PAAR-CY 2x2x0.5 mm² (AWG 20), blue Ex



Part no.: 920326

Fire alarm cable (blue) for signal transmission in hazardous areas facilities in dry and moist plant locations. For installation in and on wall.

Quantity unit for orders = meters

Technical specifications

Line resistance at 20 °C (68 °F)	≤ 37.8 Ohm / km (0.6 miles)
Isolating resistance at 20 °C (68 °F)	≥ 20 MOhm / km (0.6 miles)
Operating capacity - lead/lead	≤ 105 nF / km (0.6 miles)
- lead/shield	≤ 145 nF / km (0.6 miles)
Inductance	approx. 0,68 mH / km (0.6 miles)
Operating voltage	900 V, not for high-voltage applications
Temperature range for fixed installation	-30 °C to +80 °C (-22 °F to +176 °F)
Temperature range for flexible installation	-10 °C to +80 °C (-14 °F to +176 °F)
Outer diameter	7.6 mm (0.3 inch)
Minimum bending radius	flexing R = 10 x D fixed R = 5 x D
Specification according to	VDE 0165
Weight	approx. 90 g / m (0.2 lbs / 39 inch)

Included in delivery

1 Packaging unit (1 cable reel a 500 m (1640 ft))
Other lengths available on request.



Cable/installation material

Cable/installation material

Cable gland M20x1.5 Vent with pressure equalization element



Technical specifications

Material	Brass, nickel-plated Sealing Chloroprene O-ring Perbunan
Connection thread	M20x1.5
Terminal connection area	6 - 11 mm (0.24 -0.43 inch)
Protection rating	IP 67 (0.1 bar)
Ambient temperature	-20 °C to +100 °C (-4 °F to +212 °F)
Weight	40 g (0.09 lbs)

Part no.: 934428

Easily installed, breathable cable gland with large sealing and terminal connection area for wide cable diameters. Integrated strain relief and anti-twist protection. To replace the standard M20 cable glands of UniVario detector bases.

Included in delivery

Cable gland M20x1.5 Vent

Note

Must not be used with industrial detectors in silicone-free design!
Not suitable for use with cold-shrink tube, part no. 905337.

Cable gland M20x1.5 Vent Ex with pressure equalization element



Technical specifications

Material	Brass, nickel-plated Sealing Chloroprene O-ring Chloroprene
Connection thread	M20x1.5
Terminal connection area	5 - 11 mm (0.2-0.43 inch)
Protection rating	IP 68 (0.1 bar)
Ambient temperature	-40 °C to +80 °C (-40 °F to +176 °F)
Weight	60 g (0.13 lbs)

Part no.: 933514

Ex-cable gland M20x1.5 with pressure equalization element.

Included in delivery

Cable gland M20x1.5 Vent Ex

Approvals / marking

Ⓜ II 2G Ex eb IIC Gb
Ⓜ II 2D Ex tb IIIC Db

Otherwise like part no. 934428

Cable gland M20x1.5 Vent EMC Ex with pressure equalization element



Technical specifications

Material	Brass, nickel-plated Sealing Chloroprene O-ring Chloroprene
Connection thread	M16x1.5
Terminal connection area	5 - 11 mm (0.5-0.43 inch)
Protection rating	IP 68 (0.1 bar)
Ambient temperature	-40 °C to +80 °C (-40 °F to +176 °F)
Weight	66 g (0.15 lbs)

Part no.: 933515

EMC-ex cable gland M20x1.5 with pressure equalization element for shielded cables.

Included in delivery

Cable gland M20x1.5 Vent EMV Ex

Approvals / marking

Ⓜ II 2G Ex eb IIC Gb
Ⓜ II 2D Ex tb IIIC Db

Otherwise like part no. 934428



Cable/installation material

Cable/installation material

Cable gland M16/M20x1.5 Ms



Technical specifications

Material	Brass, nickel-plated Viton sealing ring and O-ring
Connection thread	M16 x 1.5
Terminal connection area	9 - 13 mm (0.4 -0.5 inch)
Protection rating	IP 68 (5 bar)
Ambient temperature	-20 °C to +100 °C (-4 °F to +212 °F)
Weight	34 g (0.07 lbs)

Part no.: 907096

Easily installed cable gland with large sealing and terminal connection area for wide cable diameters. Can be used as EMC cable gland, with integrated strain relief and anti-twist protection. To replace the standard M16 cable glands on the UniVario detector base for M20 installations.

Included in delivery

Cable gland M16 / M20 x 1.5 MS

Not included in delivery

Cold-shrink tube, silicone, 25 > 6 mm (1 > 0.2 inch) 905337

Cable gland M20x1.5 Ms



Technical specifications

Material	Brass, nickel-plated Viton sealing ring outside part and O-ring Evoprene sealing ring inside part
Connection thread	M20 x 1.5
Terminal connection area	5 - 13 mm (0.2 -0.5 inch)
Protection rating	IP 68 (5 bar)
Ambient temperature	-20 °C to +100 °C (-4 °F to +212 °F)
Weight	34 g (0.07 lbs)

Part no.: 907084

EMC cable gland M20 x 1.5 with reduced sealing. M20 cable glands on the UniVario detector base for M20 installations.

Included in delivery

Cable gland M20 x 1.5 MS

Not included in delivery

Cold-shrink tube, silicone, 25 > 6 mm (1 > 0.2 inch) 905337

Cable gland M20x1.5 Ex Ms

Technical specifications

Material	Brass, nickel-plated Viton sealing ring and O-ring
Connection thread	M20 x 1.5
Terminal connection area	7 - 12 mm (0.3 -0.5 inch)
Protection rating	IP 68 (5 bar)
Ambient temperature	-20 °C to +100 °C (-4 °F to +212 °F)
Weight	34 g (0.07 lbs)

Part no.: 925958

EMC cable gland M20 x 1,5 with reduced sealing. M20 cable glands on the UniVario detector base for M20 installations.

Included in delivery

Cable gland M20 x 1.5 Ex MS

Not included in delivery

Cold-shrink tube, silicone, 25 > 6 mm (1 > 0.2 inch) 905337



Cable/installation material

Cable/installation material

Cold-shrink tube 25 > 6 mm (1 > 0.2 inch)



Part no.: 905337

Cold-shrink tube for installation of detectors or electrical devices in outdoor areas, in shipbuilding or for demanding sealing requirements, such as in machine tools. Easy installation, without tools. Reliable, durable sealing without heat application. Moisture resistance and resistance to acids, alkalis, ozone and UV. Non-flammable.

Included in delivery

Cold-shrink tube, silicone, 25 > 6 mm (1 > 0.2 inch)

Note

The installation of the cold-shrink tube is irreversible.



Cable/installation material

Cable/installation material

Cable gland M20x1.5 MS with twin insertion

Part no.: 887705



Technical specifications

Material	Brass, nickel-plated
Terminal connection area	2 x Ø 6 mm (0.2 inch)
Operating temperature	-20 °C to +100 °C (-4 °F to +212 °F)
Weight	31 g (0.07 lbs)

Not included in delivery

Gland M 20 x 1.5 PA

801722

Cable gland M20x1.5 Ms with twin insertion

Part no.: 908690

Technical specifications

Terminal connection area	2 x Ø 8 mm (0.3 inch)
Otherwise like part no. 887705	

Cable gland M20x1.5 PA 6-3 with double insertion

Part no.: 886323



Technical specifications

Material	Plastic, PA 6-3
Terminal connection area	2 x Ø 6 mm (0.2 inch)
Operating temperature	-20 °C to +100 °C (-4 °F to +212 °F)
Weight	10 g (0.01 lbs)

Not included in delivery

Gland M 20 x 1,5 PA

801722

Cable gland M20x1.5 PA 6-3 with twin insertion

Part no.: 908751

Technical specifications

Terminal connection area	2 x Ø 8 mm (0.3 inch)
Otherwise like part no. 886323	

Cable gland M20x1.5 Ex-d A4

Part no.: 920793



Technical specifications

Material	Stainless steel 1.4404
Terminal connection area	Ø 7 - 12 mm (0.28 - 0.47 inch)
Operating temperature	-60 °C to +105 °C (-76 °F to +221 °F)
Certificate	II 2G 1D Ex d IIC
Weight	45 g (0.10 lbs)



Cable/installation material

Cable/installation material

Adapter M16 x1.5Ms



Part no.: 908609

Adapter for cable glands

Included in delivery

1 Adapter M 16 x 1.5 MS
1 O-Ring Di 13 x 1.5 Viton

Technical specifications

Material	Brass, nickel-plated Viton sealing ring and O-ring
Mail thread	M16 x 1.5
Female thread	NPT 1/2"
Ambient temperature	-55 °C to +120 °C (-67 °F to +248 °F)
Weight	30 g (0.07 lbs)

Adapter M16 x1.5Ms - NPT 3/4"

Part no.: 908808

Included in delivery

1 Adapter M 16 x 1.5 - NPT 3/4" MS gal. Ni
1 O-Ring Di 13 x 1.5 Viton

Technical specifications

Material	Brass, nickel-plated Viton sealing ring and O-ring
Mail thread	M16 x 1.5
Female thread	NPT 3/4"
Wrench size	27
Ambient temperature	-55 °C to +120 °C (-67 °F to +248 °F)
Weight	80 g (0.2 lbs)

Adapter M16 x1.5Ms - NPT 1"

Part no.: 908810

Included in delivery

1 Adapter M 16 x 1.5 - NPT 1" MS gal. Ni
1 O-Ring Di 13 x 1.5 Viton

Technical specifications

Material	Brass, nickel-plated Viton sealing ring and O-ring
Mail thread	M16 x 1.5
Female thread	NPT 1"
Wrench size	32
Ambient temperature	-55 °C to +120 °C (-67 °F to +248 °F)
Weight	110 g (0.2 lbs)



Cable/installation material

Screw plugs/Cable glands

Screw plug M16 x 1.5 brass FKM

Part no.: 903720

Screw plug with metric thread.

Technical specifications

Material	Brass, galv. nickel-plated O-ring Viton
Thread	M16 x 1.5
IP rating	IP65
Specification acc. to	EN 60423
Ambient temperature	-40 °C to +100 °C (-40 °F to +212 °F)
Weight	7 g (0.02 lbs)

Included in delivery

1 Screw plug
1 O-ring Viton

Screw plug M20 x 1.5 PA FKM

Part no.: 902922

Screw plug with metric thread.

Technical specifications

Material	Polyamide, light grey RAL 7035 O-Ring Viton
Thread	M20 x 1.5
IP rating	IP65
Specification acc. to	EN 60423
Ambient temperature	-40 °C to +100 °C (-40 °F to +212 °F)
Weight	3 g (0.1 lbs)

Included in delivery

1 Screw plug
1 O-ring Viton



Cable/installation material

Screw plugs/Cable glands

Cable gland M16 x 1.5 FS GY PERFECT FKM

Part no.: 900978

Technical specifications

Material	Polyamide PA6 V-2, light grey RAL 7035
Thread	M16 x 1.5
Thread length	8 mm
Clamping range	5-10 mm
IP rating	IP68 up to 5 bar
Specification acc. to	EN 60423 EN 50262
Ambient temperature	-20 °C to +100 °C (-4 °F to +212 °F)
Weight	6 g (0.01 lbs)

Included in delivery

1 Cable gland
1 O-ring Viton
1 Gasket ring Viton

Cable gland M20 x 1,5 FS GY PERFECT FKM

Part no.: 902901

Technical specifications

Material	Polyamide PA6 V-2, light grey RAL 7035
Thread	M20 x 1.5
Thread length	8 mm
Clamping range	5-13 mm
IP rating	IP68 up to 5 bar
Specification acc. to	EN 60423 EN 50262
Ambient temperature	-20 °C to +100 °C (-4 °F to +212 °F)
Weight	9 g (0.02 lbs)

Included in delivery

1 Cable gland
1 O-ring Viton
1 Gasket ring Viton

Cable gland M20 x 1.5 mold. mat. GY SKINTOP

Part no.: 900453

Technical specifications

Material	Polyamide, light grey RAL 7035
Thread	M20 x 1,5
Clamping range	7-13 mm
IP rating	IP68 up to 5 bar
Specification acc. to	EN 60423 EN 62444
Ambient temperature	-40 °C to +100 °C (-40 °F to +212 °F)
Weight	12 g (0.03 lbs)

Included in delivery

1 Cable gland
1 O-ring
1 Sealing closure

Cable gland M20 x 1.5 mold. mat. BL SKINTOP

Part no.: 801720

Color black.
Otherwise like part no. 900453.



Cable/installation material

Screw plugs/Cable glands

Cable gland M20 x 1.5 EMC PERFECT FKM

Part no.: 907084

For cables with shield.

Technical specifications

Material	Brass, galv. nickel-plated Gasket inside FKM-Viton Gasket outside TPE-Evoprene
Thread	M20 x 1.5
Clamping range	9-13 mm
IP rating	IP68 up to 5 bar
Specification acc. to	EN 62444
Ambient temperature	-20 °C to +100 °C (-4 °F to +212 °F)
Weight	34 g (0.07 lbs)

Included in delivery

1 Cable gland
1 O-ring Viton
1 reduced sealing insert

Cable gland M16 x 1.5 Ms EMC Ex

Part no.: 904652

For cables with shield.

Technical specifications

Material	Brass, galv. nickel-plated
Thread	M16 x 1.5
Thread length	5 mm
Clamping range	6 - 8 mm
IP rating	IP66 / 68
Ambient temperature	-60 °C to +100 °C (-76 °F to +212 °F)
Weight	23 g (0.51 lbs)

Included in delivery

1 Cable gland

Approvals / marking

EU Type examination certificate: SEV 15 ATEX 0152 X
IECEx Certificate of conformity: IECEx SEV 15.0019 X

Cable gland M16 x 1.5 Ms EMC Ex

Part no.: 4003993

For cables with shield.

Technical specifications

Material	Brass, galv. nickel-plated
Thread	M16 x 1.5
Thread length	5 mm
Clamping range	8 - 10 mm
IP rating	IP66 / 68
Ambient temperature	-60 °C to +100 °C (-76 °F to +212 °F)
Weight	23 g (0.51 lbs)

Included in delivery

1 Cable gland

Approvals / marking

EU Type examination certificate: SEV 15 ATEX 0152 X
IECEx Certificate of conformity: IECEx SEV 15.0019 X



Cable/installation material

Screw plugs/Cable glands

Cable gland M20 x 1,5 FS SW Ex PERFECT

Part no.: 905167

Technical specifications

Material	Polyamide, black RAL 9005
Thread	M20 x 1.5
Thread length	8 mm
Clamping range	5.5 - 13 mm
IP rating	IP66
Specification acc. to	EN 60529
Ambient temperature	-20 °C to +70 °C (-4 °F to 158 °F)
Weight	11 g (0.02 lbs)

Approvals / marking

EU Type examination certificate:
IECEx Certificate of conformity:

PTB 14 ATEX 1015 X
IECEx PTB 14.0027 X

Cable gland M25 x 1.5 FS PERFECT

Part no.: 904985

Technical specifications

Material	Polyamide PA6 V-2, light grey RAL 7035 Gasket inside TPE
Thread	M25 x 1.5
Thread length	8 mm
Clamping range	8-17 mm
IP rating	IP68 up to 5 bar
Specification acc. to	EN 60423
Ambient temperature	-20 °C to +100 °C (-4 °F to +212 °F)
Weight	16 g (0.04 lbs)

Included in delivery

1 Cable gland

Cable gland M32 x 1.5 FS GR PERFECT

Part no.: 901977

Technical specifications

Material	Polyamide PA6 V-2, light grey RAL 7035 Gasket inside TPE Gasket outside CR/NBR
Thread	M32 x 1.5
Thread length	10 mm
Clamping range	12 - 21 mm
IP rating	IP68 up to 5 bar
Specification acc. to	EN 60423 EN 50262
Ambient temperature	-20 °C to +100 °C (-4 °F to +212 °F)
Weight	27 g (0.06 lbs)

Included in delivery

1 Cable gland



Cable/installation material

Cable ties

Cable tie 98 x 2.5 mm

Part no.: 140114

Technical specifications

Material	PA 6.6,
Drag	80 N
Ambient temperature	-40 °C to +90 °C (-40 °F to +194 °F)
Dimensions	98 x 2,5 mm (LxW) 3.9 x 0.1 inch (LxW)
Weight	1 g (0.0002 lbs)

Cable tie 100 x 2.5 mm

Part no.: 905284

Technical specifications

Material	PA 6.6
Drag	78 N
Ambient temperature	-40 °C to +90 °C (-40 °F to +194 °F)
Dimensions	100 x 2.5 mm (LxW) 3.9 x 0.1 inch (LxW)
Weight	4 g (0.0009 lbs)

With mounting hole for bolt or screw M3.

Cable tie 140 x 3.5 mm

Part no.: 209791

Technical specifications

Material	PA 6.6r
Drag	140 N
Ambient temperature	-40 °C to +90 °C (-40 °F to +194 °F)
Dimensions	140 x 3.5 mm (LxW) 5.5 x 0.14 inch (LxW)
Weight	4 g (0.0009 lbs)

Cable tie 200 x 3.5 mm

Part no.: 816839

Technical specifications

Material	PA 6.6
Drag	130 N
Ambient temperature	-40 °C to +90 °C (-40 °F to +194 °F)
Dimensions	200 x 3.5 mm (LxW) 7.9 x 0.14 inch (LxW)
Weight	6 g (0.013 lbs)

Cable tie 290 x 4.8 mm

Part no.: 911802

Technical specifications

Material	PA 6.6,
Dimensions	290 x 4.8 mm (LxW) 11.4 x 0.19 inch (LxW)
Weight	2 g (0.0004 lbs)



Cable/installation material

Resistors

Resistor 1 K 3/4 W 1% MBE	Part no.: 801388
----------------------------------	-------------------------

Resistor 1,8 K 3/4 W 1% MBE	Part no.: 801390
------------------------------------	-------------------------

Resistor 3,3 K 1/2 W 5% SFR	Part no.: 670365
------------------------------------	-------------------------

Resistor 10 K 1/2 W 5% SFR	Part no.: 668810
-----------------------------------	-------------------------

Resistor 470 E 1/2 W 5% SFR	Part no.: 675223
------------------------------------	-------------------------

Resistor 10 K 3/4 W 1% MBE	Part no.: 839964
-----------------------------------	-------------------------

Resistor 680 E 1/2 W 5% SFR16	Part no.: 670353
--------------------------------------	-------------------------



Cable-/installation material

Switching device

Revision equipment



Product features

- Execution of the functional shut-off testing of equipment and devices in conformity with standards and directives
- No interruption of production or machine shutdown

Technical specifications

Switching voltage	5 - 250 V AC / V DC
Switching current	4 mA - 4 A
Control via FACP/ECD	see functional Module Control groups (24 V DC)
Feedback to FACP/ECD	see functional Module Conventional detector (quiescent current monitored current booster group)
IP rating	IP 65
Enclosure material	Polycarbonate grey similar RAL7035
Seal	Polyurethane
Cable gland	2 x M20x1,5
Ambient temperature	-25 °C to +60 °C (-13 °F to +140 °F)
Relative humidity at 25 °C (77 °F) (short term)	max. 95% no condensation
Weight	323 g (0.71 lbs)
Dimensions	124 x 122 x 55 mm (LxWxD) 4.9 x 4.8 x 2.2 inch (LxWxD)

Part no.: 931531

The Revision equipment enables the functional shut-off testing of equipment and devices without interruption of productions, or machine shutdowns. In case of fire, a relay with positively driven contacts is activated by the monitored control output of the FACP/ECD and switches off the connected equipment. For functional tests, the shut-off contact is bridged with the key switch (LED display: Shut-off bypassed). The connected equipment remains active. The connected conventional line provides a corresponding feedback signal to the FACP/ECD. The switching function of the relay with positively driven contacts is displayed after appropriate activation by the LED „Relay activated“.

Included in delivery

Cable gland 2 x M20x1,5

Spare parts

Fuse 4 A / 250 V miniatur time-lag

150276

Connection diagram

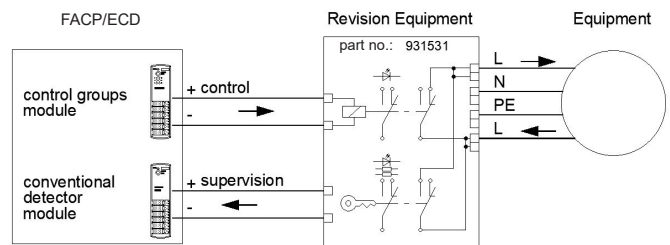

Approvals / marking





Cable-/installation material

Control and signal unit

Plug GDME 3020



Part no.: 4003873

Field attachable solenoid valve connector to connect the monitoring modules Card LÖ leakage detector, Card MVA LÖ, Card MVA LÖ redundant or Card MVA impulse. With central screw M3 x 40.

Technical specifications

Contacts	4 poles (3 + PE)
Type	Form A
Cable gland	M20
IP rating	IP 65
Ambient temperature	-25 °C to +85 °C
Material plug	PA GF
Color	black / transparent cover
Material gasket	NBR rubber
Weight	0.058 kg

Included in delivery

Plug GDME 3020
Gasket GDM3-7

Spare parts

Gasket GDM3-7

4004885

Approvals / markings



Plug GDME 3013

Part no.: 761094

Cable gland PG13.5.

Otherwise like part no. 4003873.

Europe, Middle East & Africa

BENELUX

Viking SupplyNet bv
Hinmanweg 11d
NL-7575 BE Oldenzaal
The Netherlands
Tel.: +31 (0)541 573233
vikingnetherlands@viking-emea.com

CENTRAL & EASTERN EUROPE

Viking GmbH
Industriestr. 10/12
D-23840 Bad Oldesloe
Germany
Tel.: +49 (0)4531 803 8087
vikinggermany@viking-emea.com

FRANCE

Sprinkler Viking France S.à r.l.
Centre d'Affaires CESCO
4, rue Marconi
BP 25180
F-57075 Metz Cedex 03
France
Tel.: +33 (0)800 10 29 23
vikingfrance@viking-emea.com

IBÉRICA

Viking Sprinkler S.A.
Calle Picos de Europa 4A
San Fernando de Henares
E-28830 Madrid
Spain
Tel.: +34 91 677 8352
vikingiberica@viking-emea.com

ITALY

Viking Italia S.r.l.
Via Pavia, 76
I-27042 Bressana Bottarone (PV)
Italy
Tel.: +39 0383 80071
vikingitaly@viking-emea.com

MIDDLE EAST

Viking Arabia FZE
LOB 19 Office #2007
Post Box No. 17531
Jebel Ali Free Zone, Dubai
United Arab Emirates
Tel.: +971 (0)4 8895 561
vikingdubai@viking-emea.com

NORDIC

Viking Nordic AB
Staffans Väg 5
S-192 78 Sollentuna
Sweden
Tel.: +46 (0)8 594 415 90
vikingsweden@viking-emea.com

POLAND

Viking SupplyNet Sp. z o.o.
ul. Żelazna 59
PL-00 848 Warsaw
Poland
Tel.: +48 22 103 30 54
vikingpoland@viking-emea.com

ROMANIA & BULGARIA

Viking Romania S.r.l.
Strada Vulturilor 18-18A, cam 3
The LOBBY
RO-030855 Bucharest
Romania
Tel.: +40 21 311 51 48
vikingromania@viking-emea.com

TURKEY

Viking Turkey Yangın Korunum Sistemleri Ticaret A.Ş.
Sahrayıcedit Mah. Halk Sokak
Golden Plaza C Blok No:29, Kat:4, Daire:8
Sahrayı Cedit, Kadıköy - 34734 İstanbul
Turkey
Tel.: +90 (0)216 403 18 00
vikingturkey@viking-emea.com

UK & IRELAND

Viking SupplyNet Ltd.
Unit 2 - Byram House, Newborn Court
Chapel Street
Epworth DN9 1HQ
United Kingdom
Tel.: +44 (0)1427 871 000
vikinguk@viking-emea.com

For further information,
please visit
www.viking-emea.com



In all cases the full product datasheet remains the reference document
Information, photos and drawings are not contractually binding
Subject to modifications without notice

Trusted above all.

Viking S.A. | 21, Z.I. Haneboesch, L-4562 Differdange / Niederkorn, Luxembourg | Tel.: +352 58 37 37 - 1 | vikinglux@viking-emea.com

